

**IE252 Manufacturing Processes
Laboratory Manual V1.1**

Dr Ali Mohammed Al Samhan



Unit 1 Metal Forming Experiments.

- 1.1 Open Die Forging- Compression test.
- 1.2 Bulk Forming – Extrusion Experiment

Unit 2: Casting Experiments

- 2.1 Sand Casting Process Experiment
- 2.2 Sand casting tests

Unit 3: Welding Experiments.

Unit 4: Sheet Metal Forming and Press Work.

Unit 1: Metal Forming Experiments

1.1 Open Die Forging – Compression Test Experiment

1.1.1 Introduction to physical modeling in metal forming processes

Analysis of metal forming processes is commonly performed utilizing analytical, numerical, or physical techniques. In the analytical approach, a closed-form solution of plasticity theory is employed to obtain such information as the required forming loads, formation of flaws, tool–work-piece friction conditions, etc.

Due to the complexity of the equations involved in the analytical approach, application of such methods is only practical for the case of simple geometries and boundary conditions. Numerical techniques, such as the Finite Element Method (FEM), are based on approximation and discretization of domain. Recent advancements in computer technology made significant contributions towards the application of numerical methods for solving incremental plasticity equations.

Similar to analytical methods, numerical techniques are used to predict the required forming loads, formation of flaws, tool/work-piece interface stress distributions, as well as information such as stress

and strain distributions, residual stress patterns, tooling stresses or distortions, and temperature gradients.

Despite the above advantages, successful implementation of analytical and numerical methods requires an accurate knowledge of the material constitutive equations, process mechanics and frictional conditions. Inaccurate information about any of these parameters will lead to highly erroneous results. Furthermore, implementation of sophisticated FEM codes requires not only powerful computers, but also highly trained technical personnel who are familiar with both the software and the forming process under investigation.

The Physical Modeling Technique is an alternative analysis method for providing information on the plastic flow of metals, load predictions, formation of voids or flaws, and fields to investigate plane strain metal forming conditions, see Fig. 1.1. The main advantage of the physical modeling approach over analytical and numerical methods is its

relative simplicity and ease of implementation, i.e. it neither requires elaborate facilities nor in depth knowledge of the theory of plastic deformation. Also, since the load required deforming a model material are much lower than those necessary to deform the actual material, less expensive equipment may be used to perform the analysis.

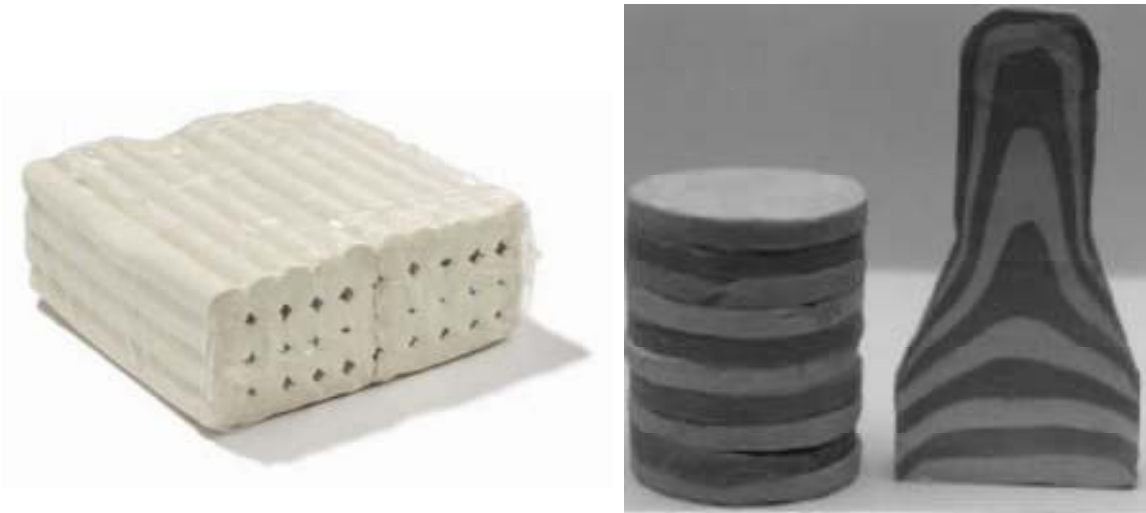

(a)

(b)

Fig. 1.1 (a) Plasticine stock commonly used in physical modeling, (b) Plasticine with different color layers modeled for direct extrusion process.

For instance, a simple tension/compression testing machine can be used to form a model material, whereas a large production press might be required to form the actual material. Successful implementation of the physical modeling technique is based on the simulation of an actual metal forming process utilizing a model material and tools under conditions similar to the actual process. Typical modeling materials used in the physical modeling technique are Plasticine, lead, and wax, while typical model dies are frequently made of steel, aluminum, or plexiglass.

The most widely used modeling material in deformation studies is Plasticine, a registered trade name by Harbutt, UK which has recently been acquired by Peter Pan Playthings. It must be noted that Plasticine is not the name of the material but a brand of modeling material developed in 1890's in Europe. A common misconception is not to capitalize the

name, as Plasticine, indicating its use in a generic sense. According to the manufacturer of Plasticine, although the basic ingredients for various colors of this modeling material are similar, different agents are employed in making each color. This means that the overall composition of each color is different from that of other colors. Therefore, one can expect some variations in the mechanical behavior of Plasticine from one color to another. When using different colors of this modeling material to form a uniform model, one must insure that the mechanical behaviors of the various colors are similar in order to insure homogeneity throughout the material. Although for many years Plasticine has shown its effectiveness in providing qualitative data regarding flow behavior of metals, there still remains the question of its validity as a modeling medium. This is mainly due to lack of physical data on the flow characteristics of this material. Therefore, the purpose of this experiment is to determine the constitutive equations of one type of Plasticine in order to identify its material flow curve. This can be done by evaluating the strain-hardening (work-hardening) exponent, n , and the strength coefficient, K , used in the well-known power law equation, given by $\sigma = K \epsilon^n$

1.1.2 Theoretical background

The flow curve of a material (true stress–true strain relationship) can be determined from either tension or compression tests [7].

Also, the flow stress values determined at high strains in the tensile test require a correction because of necking. Therefore, the compression test, which can be conducted without barreling at up to about 50% reduction in height, is widely used to obtain flow stress–strain data for metal forming applications. In a typical compression test, a cylindrical specimen is compressed between parallel flat platens as shown in Fig. 1. The load and displacement, or sample height, are measured during the test. This data is later used to determine the flow stress–strain relationship. The following relationships are used for the uniform compression test. The true stress is given by:

$$\sigma = \frac{F}{A} \tag{1.1}$$

while the true strain is

$$\epsilon = \ln\left(\frac{H}{H_0}\right) = \ln\left(\frac{A}{A_0}\right) \tag{1.2}$$

Where

A_0	original area, mm ²
A	instantaneous area, mm ²
H_0	original height, mm
H	instantaneous height, mm
F	compression force, N
S	engineering (conventional) stress, MPa
e	engineering (conventional) strain
σ	true stress, MPa
ϵ	true strain
E	Young's modulus, MPa
K	strength coefficient, MPa
n	strain-hardening (work-hardening) exponent
r	correlation factor

Denoting the instantaneous deformation velocity by

$$V = \left(\frac{dH}{dt} \right) \quad 1.3$$

The true strain rate can be written as

$$\dot{\epsilon} = \frac{d\epsilon}{dt} = \frac{d}{dt} \left(\ln \left(\frac{H}{H_0} \right) \right) = \frac{dH}{H dt} = \frac{V}{H} \quad 1.4$$

Using Equation 1.3

$$\dot{\epsilon} = \frac{V}{H_0 \exp(\epsilon)} \quad 1.5$$

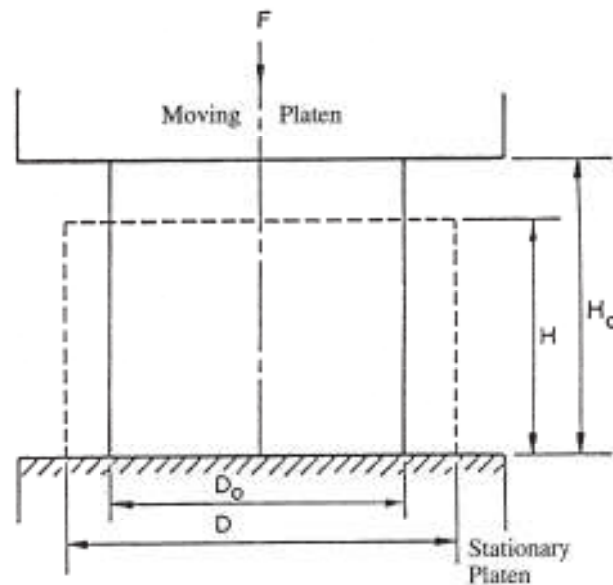

Fig 1.2 Homogeneous compression of a solid cylindrical specimen

Eq. (1.5) indicates that the strain rate, during constant deformation speeds (constant V) of compression test, changes throughout the experiment. Since at room temperature the flow stress of most metals is essentially strain-rate independent, any testing machine can be used for the compression test, regardless of its crosshead speed. However, at hot working temperatures, i.e. above the recrystallization temperature, the flow stress of almost all metals is very much strain-rate dependent. Thus, when possible, compression tests for characterizing high temperature flow behavior of metals must be conducted on a machine which is capable of changing the deformation velocity such that the strain-rate, as given by Eq. (1.5), is maintained constant throughout the test.

As mentioned previously, flow stress–strain relationship representing the plastic deformation behavior of metals at room temperature is given by the well-known power law, $\sigma = K \epsilon^n$. A graph of this equation is a straight line when plotted on log–log paper. Such a graph, as shown in Fig. 1.3, contains three significant zones: the elastic zone shown by line AB, the plastic zone shown by segment CD, and an intermediate zone. For the elastic portion, one can write

$$\sigma = E \epsilon \tag{1.6}$$

Or

$$\log \sigma = \log E + 1.0 (\log \epsilon) \tag{1.7}$$

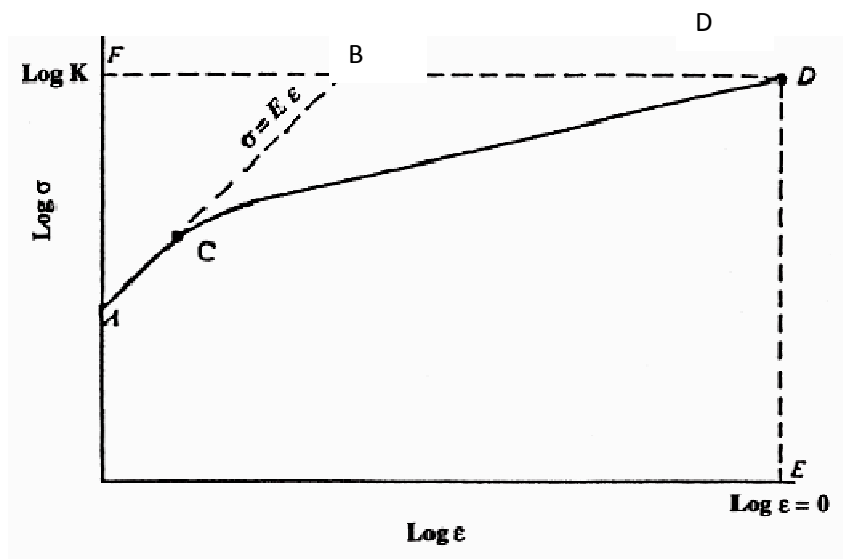

Fig 1.3 Schematic true stress/strain flow curve plot on log-log paper

Similarly, Eq $\sigma = K \epsilon^n$ can be written as follows:

$$\log \sigma = \log K + n (\log \epsilon) \quad 1.8$$

Comparing Eqs. (1.8) and (1.9), it can be concluded that the elastic portion of the lines is the same for all materials, having a slope of unity and passing through the point $(\log(\sigma) = \log(E), \epsilon = 1)$. Furthermore, it can be deduced that the elastic portion must have an exponent $n=1$ and an intercept $K=E$. The constant K in Eq. $\sigma = K \epsilon^n$ is the true stress corresponding to a true strain of unity. This constant can be determined by extending the plastic zone line (CD) until it intercepts an ordinate through $\log(\epsilon) = 0$. The height of this ordinate is $\log K$. The strain hardening exponent determine by fitting the CD plastic zone with linear regression curve fit, the slope of the line represent strain exponent n .

1.1.3 Experimental Procedure

Commercially available Plasticine contains a considerable amount of air pockets. In order to establish a reasonable degree of homogeneity, these air pockets should be squeezed out of the material. First, slabs of the modeling material were heated to 50°C in order to make it softer and easier to handle.

Having removed the air pockets by working the material through repeated rolling and folding operations, the material was shaped into cylindrical specimens 25.4 mm diameter (1 in pipe PVC tube) and length of 76.2 mm (3 in) by compressing the material into a PVC tube of 25.4 mm (1 in) in diameter and 76.2 mm (3 in) in length.

Once the entire tube was filled, the modeling material was pushed out and then divided into three 25.4 mm (1 in) segments. Prior to filling the PVC tube with the modeling material, the inner surface of the tube was dusted with talcum powder to prevent the modeling material from sticking to the tube. The two end segments were discarded while the middle segment was used in subsequent compression tests. This procedure was necessary in order to minimize the end effects and to obtain a completely cylindrical specimen. After finishing the preparation of the compression test specimen, it was placed between two Instron round jaw platens. Where the load required compressing the specimen was provided by an *Instron* tension/compression testing machine at 5.1

mm/min. (0.2 ipm) throughout the tests. It is recommended to carry out the test for at least 3 specimens. Later on, these data were used to obtain the flow characteristics such as true stress–true strain curve, strain hardening exponent, n , and strength coefficient, K . Generally, it is difficult to produce homogenous deformation in compression testing because of the presence of friction at the interface of the specimen and the compression platens. Material adjacent to the platens may thus be prevented from sliding radically outwards. As the compression proceeds and platens approach each other, the remaining material is caused to move radically outwards by the dead metal zones which results in “barreling.” Therefore it is necessary that both platens and specimen be well lubricated. It is important to note that as the platens approach each other, material which was originally on the cylindrical surface of the specimen moving in radial direction may ultimately appear at the specimen–platen interfaces. It is thus necessary to lubricate the cylindrical surface of the specimen as well as the end faces of specimen and the platens. In this study, talcum powder was used as a lubricant. The barreling effect, which is one of the most important factors affecting reliability of compression tests, was essentially eliminated.

1.1.4 Experimental Results

Fig. 1.4 shows a typical load-displacement curve obtained in uniform compression of a Plasticine (type stone) at room temperature.

The load-displacement data obtained from compression tests were incorporated in Eqs. (1.2) and (1.3) to calculate the corresponding true stress and true strain values. Fig. 1.5 shows the true stress–true strain curves (flow curves) for the sixteen types Plasticine, including Stone type. In order to represent the flow behavior of the specimens by the well-known power law equation, the true stress–true strain data were plotted on log–log paper and the coefficients K and n were determined according to the procedure described earlier. Fig. 1.5 shows the true stress–true strain data, as plotted on log–log scale for all types of Plasticine, including Stone type, see Fig 1.6. Table 1.1 shows the predicted strength coefficient, K , and strain-hardening exponent, n .

Table 1.1 Predicted values of flow curve $\sigma = K \epsilon^n$

Flow Curve Data	Predicted Value
K (MPa) Strength Coefficient	0.222
n Strain hardening exponent	0.141

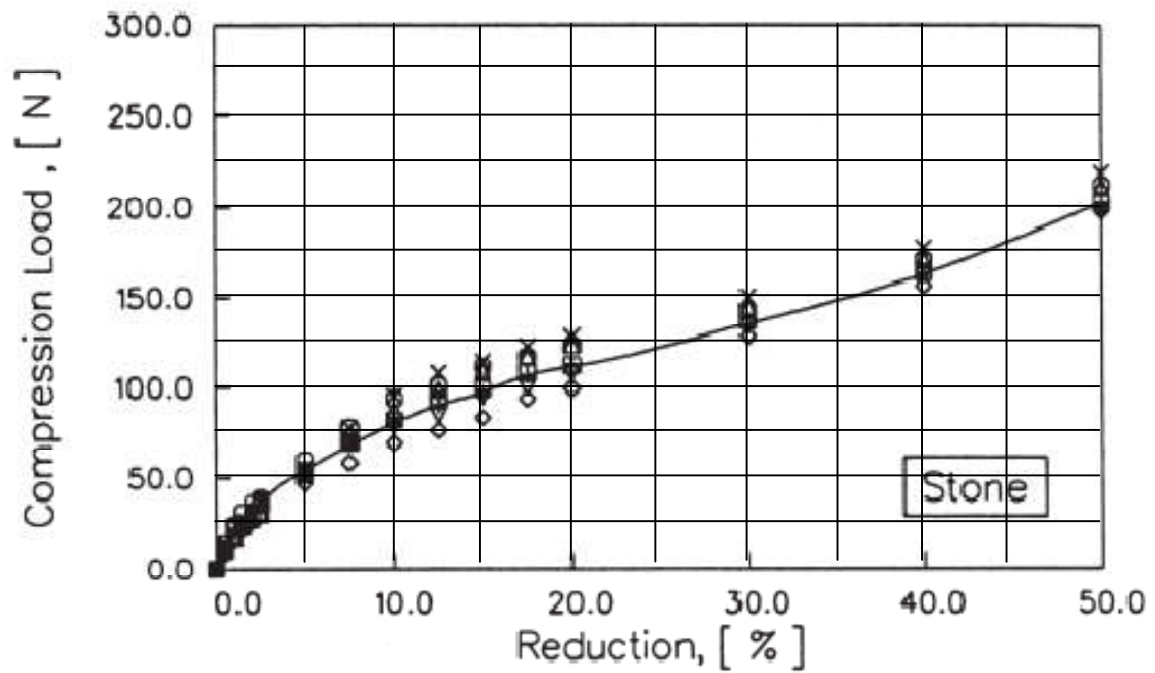

Fig 1.4 Experimental flow curve obtained Instron

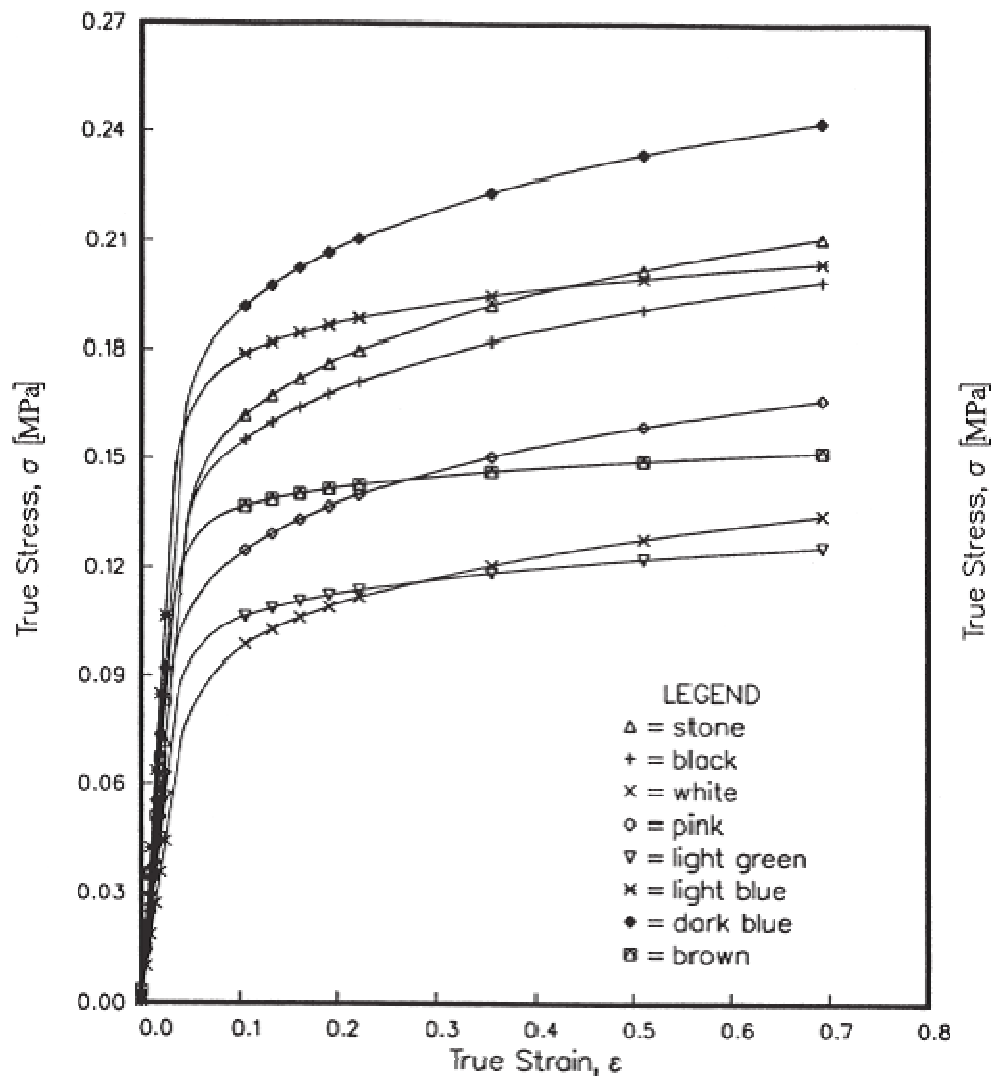

Fig 1.5 Predicted flow curve for sixteen types Plasticine, including Stone Plasticine.

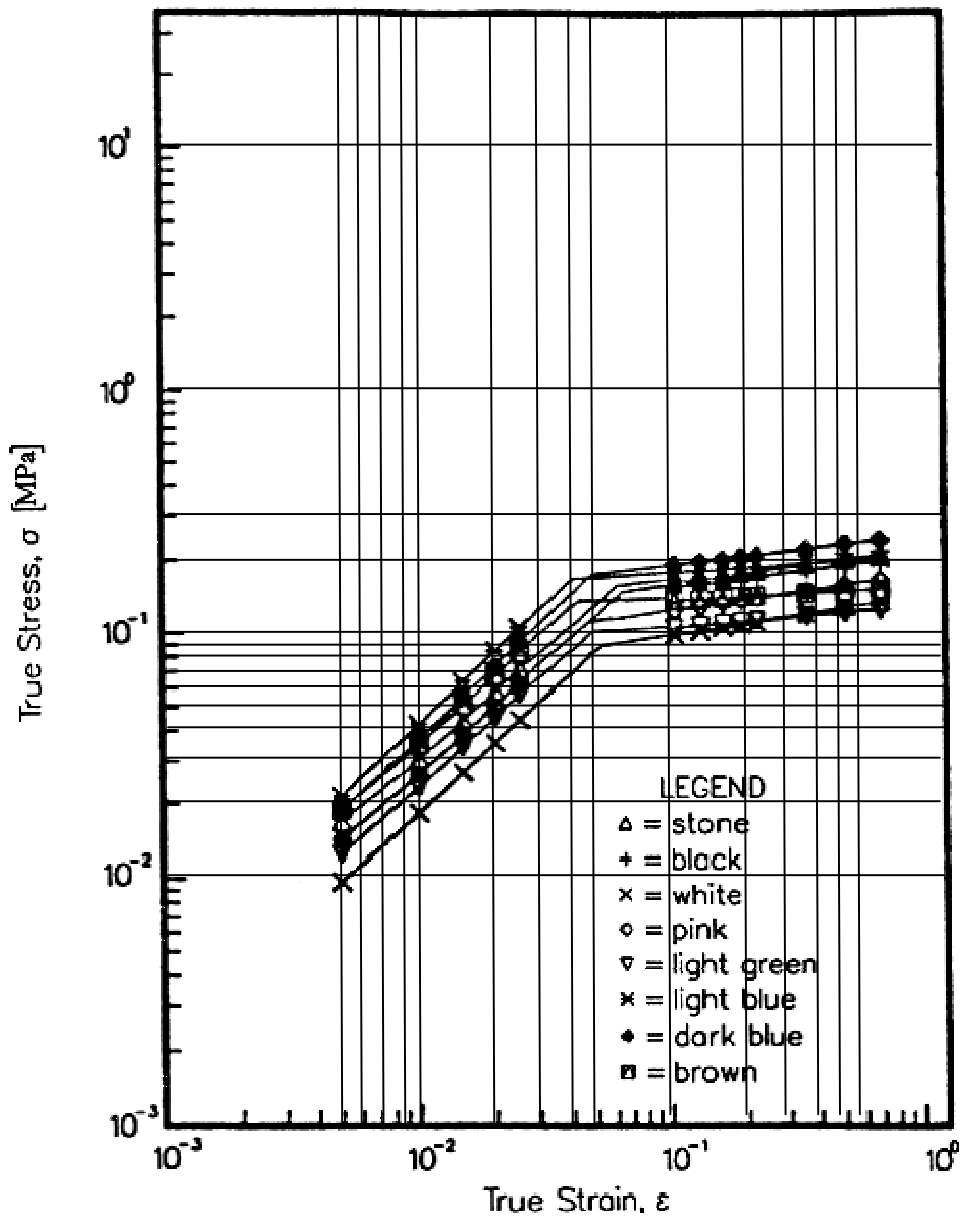

Fig 1.6 Predicted Log-Log flow curve for sixteen types Plasticine, including Stone type.

1.1.5 Experiment Objectives

Obtain material properties of the given Plasticine for power law $\sigma = K \epsilon^n$, the strength coefficient and strain hardening exponent (K and n) using compression test.

1.1.6 Equipment

Instron tension/compression testing machine, Plasticine, Three inch PVC tube.

1.1.7 Experimental Tasks:

- Step : 1.** Prepare the Plasticine sample/samples 25.4mm diameter x 25.4mm length.
- Step : 2.** Set the two upset flat plate jaws on the Instron, and lubricate them using either talcum powder or Vaseline wax.
- Step : 3.** Carry out the loading conditions up to 50% of height reduction.
- Step : 4.** Report the load (Newton), height reduction % on table form and plot the load height reduction% curve, similar to Fig 1.4.
- Step : 5.** Convert the Load (Newton) and height reduction % to stress and strain values, using Eq. 1.1. and 1.2. List the calculated data in the table form (it is recommended to use XLS file).
- Step : 6.** Plot the flow curve (Stress/strain curve) as log-log form, as shown in Fig 1.6.
- Step : 7.** As shown in Figs. 1.5 and 1.6, most of the data points fall into two distinct zones, namely, elastic and plastic regions. It is interesting to note that the first five points in each test generated a straight line with a slope close to unity when plotted on a log-log scales (Fig. 1.6). The intersection of the elastic line with the ordinate at $\epsilon=1$ ($\log \epsilon=0$) gives the value of Young's modulus. Further deformation of the Plasticine specimen, beyond elastic strain limit, resulted in plastic deformations with strain hardening exponents. Get the value K at $\log \epsilon=0$ ($\epsilon=1$).
- Step : 8.** Get the value of the strain hardening exponent n , by getting the slope of the curve CD, see Fig 1.3. It is recommended to use a linear least-squares method of regression to fit a straight line CD.
- Step : 9.** Comment on the results obtained.
- Step : 10.** Use spread XLS sheet to calculate and plot your curve, and deliver software file for all reported results. Comment on results and draw your conclusions.

1.2 Bulk Forming – Extrusion Experiment

1.2.1 Introduction to extrusion metal forming process

Description: Extrusion process is characterized as a solid material, one-dimensional forming process with compressive state of stresses. In extrusion, a work-piece (billet) of cylindrical shape is placed in closed container. The closed container has an orifice (extrusion die) and extrusion punch, that forces the material toward the extrusion die orifice, see Fig. 1.7. Two distinguished techniques are commonly used in extrusion, namely; forward and backward extrusions.

Extrusion Processes: Fig. 1.7 shows the two commonly used extrusion techniques, direct (forward) and indirect (backward) extrusion.. In direct extrusion, punch-displacement is equal to the extruded product displacement both in magnitude and direction, while; the punch has an opposite displacement direction, compared to the extruded product displacement in case of indirect process. Furthermore, hollow ram or punch is used in case of indirect extrusion, while solid ram is used in case of direct extrusion. Load capacity is larger in case of direct extrusion when compared with indirect extrusion process.

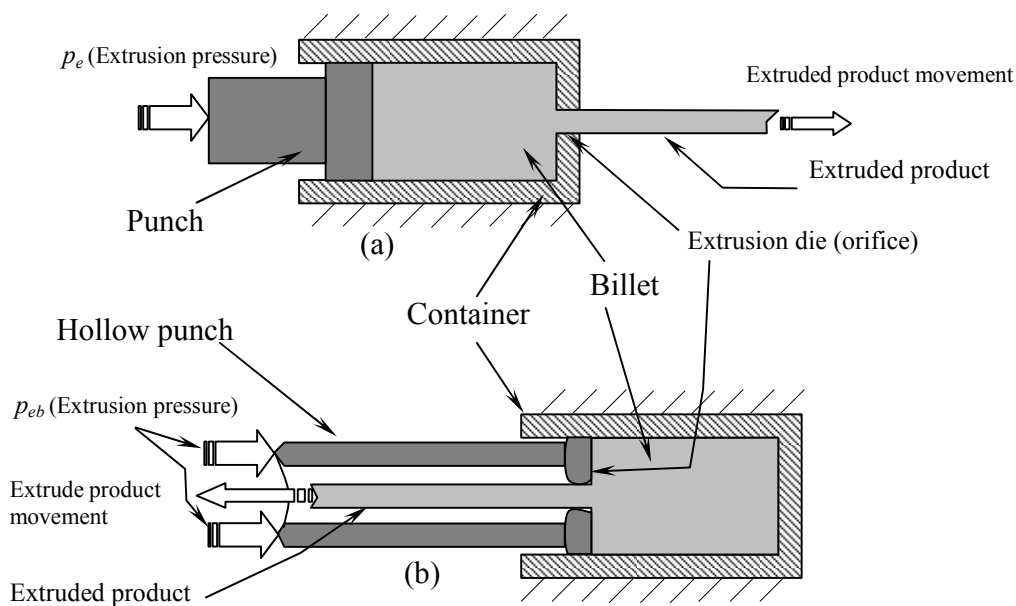
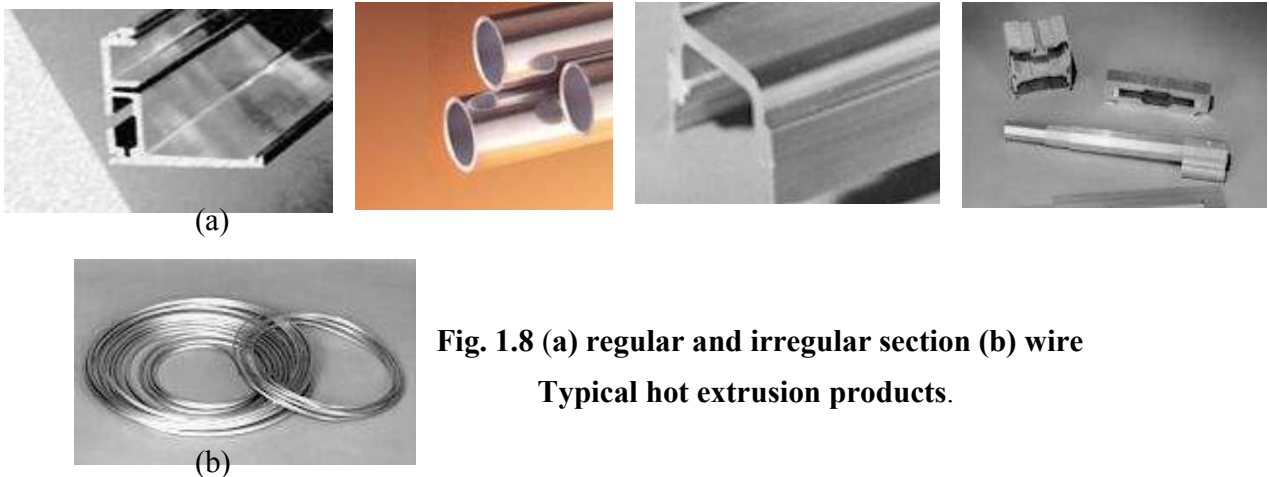

Fig. 1.7 (a) Direct (forward) extrusion process.

(b) Indirect (backward) extrusion process.

Applications : Hot and cold extrusion processes are common. Hot extrusion is commonly used to produce wide range of regular and irregular cross-sections, e.g. window frame cross-sections, door frame cross-sections, electric motor frames, angles, I section, H section .etc. Furthermore, wire products can be used as raw material for electric cable and wire industries, through wire drawing process. Fig. 1.8 shows regular and irregular sections that can be produced using hot extrusion process.



**Fig. 1.8 (a) regular and irregular section (b) wire
Typical hot extrusion products.**

Cold extrusion is commonly used in conjunction with (combination) forging process both in direct and indirect forms.

Materials: ferrous and non-ferrous metals are commonly extruded in hot extrusion which provide sufficient ductility during the deformation at elevated temperature. For example, aluminum is heated between 450-500C. At these temperatures the flow stress of the aluminum alloys is very low and by applying pressure by means of a ram to one end of the billet the metal flows through the steel die, located at the other end of the container to produce a section, the cross sectional shape of which is defined by the shape of the die.

Extrusion machines : special horizontal hydraulic presses are used for hot extrusion while general vertical mechanical and hydraulic presses are commonly used for cold extrusion. Billets are commonly of round cross-sections having diameters range between 50 and 500 mm and length from 2-4 times the diameter size.

Surface finish and tolerances: Hot extrusion provides good surface finish especially with non-ferrous materials, while cold extrusion provides closed tolerances (between 0.1-1.0%).

1.2.2 Theoretical background

The extrusion process is classified based on the type of cross-section into two categories, Rod extrusion and Tube extrusion (closed hollows of regular or irregular cross-sections).

Both extrusion processes are carried out either as direct or indirect. Fig. 1.9, shows different types of extrusion process.

Effective stress and strain calculation: The principle stresses along direction 2 and 3 are equal, due to billet axi-symmetric. Hence, the effective stress is obtained as follows;

$$\bar{\sigma} = \frac{1}{2} [(\sigma_1 - \sigma_2)^2 + (\sigma_2 - \sigma_3)^2 + (\sigma_3 - \sigma_1)^2]^{1/2} \quad \text{where } \sigma_2 = \sigma_3$$

Eq.5.1a

Then

$$\bar{\sigma} = \left\{ \frac{1}{2} [(\sigma_1 - \sigma_3)^2 + (\sigma_3 - \sigma_3)^2 + (\sigma_3 - \sigma_1)^2] \right\}^{1/2} \text{ or}$$

Eq.1.8

$$\bar{\sigma} = \left\{ \frac{1}{2} [(\sigma_1 - \sigma_3)^2 + (\sigma_3 - \sigma_1)^2] \right\}^{1/2} = (\sigma_1 - \sigma_3)$$

The principle strains are given as $\varepsilon_1 = \ln(l_f / l_o)$, $\varepsilon_2 = \varepsilon_3$ and using the volume constancy

$\varepsilon_1 + \varepsilon_2 + \varepsilon_3 = 0$; $\varepsilon_1 = -2\varepsilon_2 = -2\varepsilon_3$ or $\varepsilon_3 = -0.5\varepsilon_1$ and $\varepsilon_2 = -0.5\varepsilon_1$, the effective strain will be given as follows;

$$\bar{\varepsilon} = \left\{ \frac{2}{3} (\varepsilon_1^2 + \varepsilon_2^2 + \varepsilon_3^2) \right\}^{1/2} = \varepsilon_1$$

Eq.1.9

Extrusion ratio (R); The extrusion ratio is defined as the ratio between the initial billet area to its final cross-sectional area or $R = (A_o / A_f)$. The effective strain expressed based on the extrusion ratio is given as:

$$\bar{\varepsilon} = \varepsilon_1 = \ln(A_o / A_f) = \ln(R)$$

Eq.1.10

In practice, extrusion ratios between 40:1 for ferrous metals and between to 400:1 for aluminum alloys are acceptable.

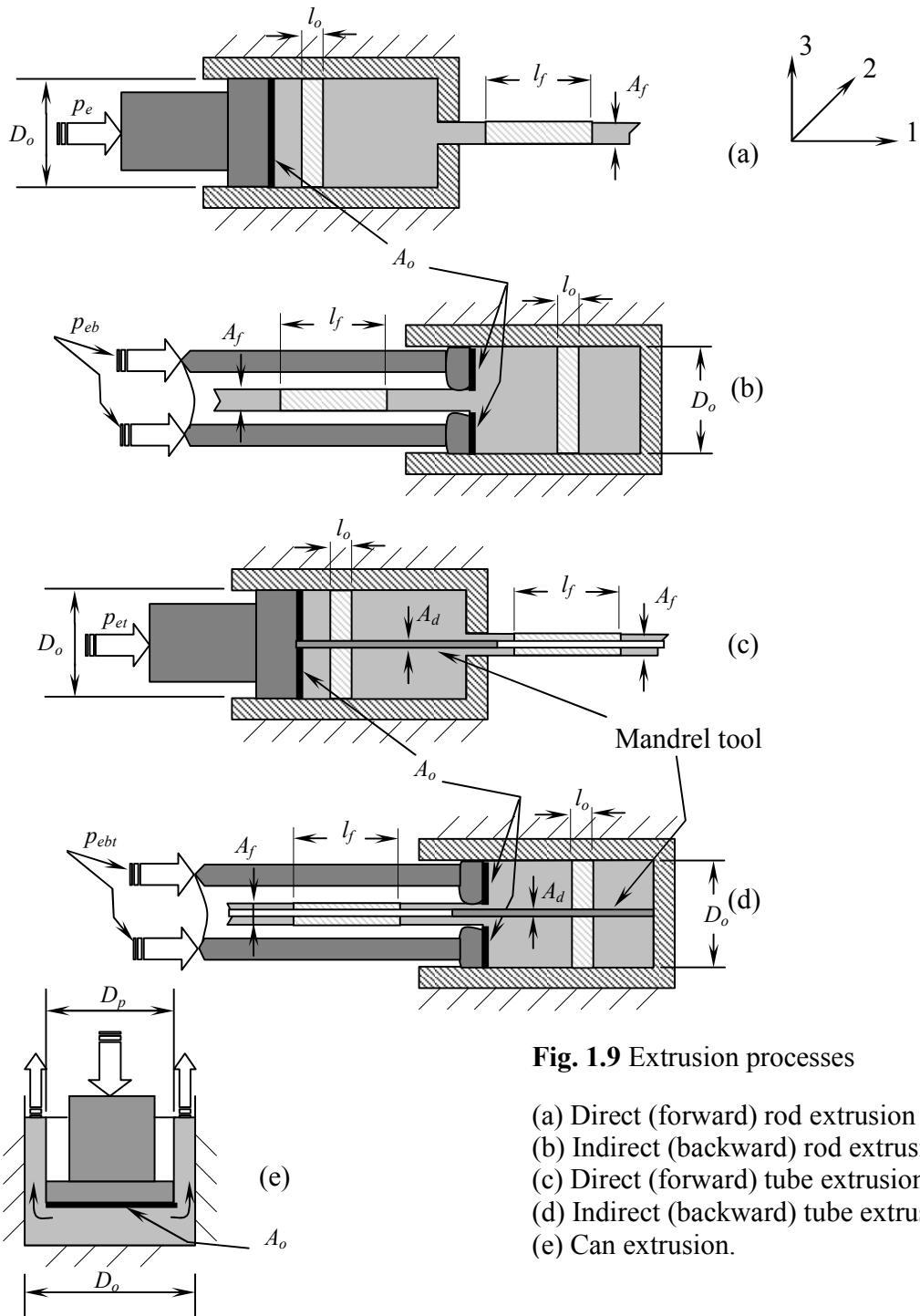

1.2.3 Load and power estimation:

The external pressure is obtained by equating the external work of the extrusion force to the internal work of the deformation ($W_{ext}=W_{int}$), where $\bar{\epsilon}_1 = 0$, $\bar{\epsilon}_2 = \bar{\epsilon}$

$$W_{int} = Vol . w = Vol \frac{K}{n+1} (\bar{\epsilon})^{n+1} \quad \text{Eq. 1.11a}$$

$$W_{ext} = P_e L = p_e A_o L_o = p_e Vol \quad \text{Eq.1.11b}$$

where P_e ; extrusion force, p_e ; extrusion pressure, A_o ; extrusion pressure area, and L_o ; extrusion force-displacement. Hence, extrusion pressure is obtained by equating Eq. (4.4a)and (4.4b) as shown below:

$$p_e = \frac{K}{1+n} (\bar{\epsilon})^{n+1} = \frac{K}{1+n} (\ln R)^{n+1} \quad \text{Eq.1.11c}$$

Amending Eq.4.4c for friction effect and redundant deformation by 50%, then

$$p_e^* = 1.5 \frac{K}{1+n} (\bar{\epsilon})^{n+1} = 1.5 \frac{K}{1+n} (\ln R)^{n+1} \quad \text{Eq.1.11}$$

This equation is used to estimate the extrusion pressure for different cross-sections, for example considering round and tube cross-sections;

a) Direct round rod extrusion:

$$p_e^* = 1.5 \frac{K}{1+n} (\bar{\epsilon})^{n+1} = 1.5 \frac{K}{1+n} (\ln R_e)^{n+1} = 1.5 \frac{K}{1+n} \left(\ln \frac{A_o}{A_f} \right)^{n+1},$$

$$\text{Where } A_o = \frac{\Pi}{4} D_o^2, A_f = \frac{\Pi}{4} D_f^2 \text{ and } R_e = \frac{A_o}{A_f} = \left(\frac{D_o}{D_f} \right)^2.$$

b) Indirect round rod extrusion:

$$p_{eb}^* = 1.5 \frac{K}{1+n} (\bar{\epsilon})^{n+1} = 1.5 \frac{K}{1+n} (\ln R_{eb})^{n+1} = 1.5 \frac{K}{1+n} \left(\ln \frac{A_o}{A_f} \right)^{n+1} \text{ Where}$$

$$A_o = \frac{\Pi}{4} (D_o^2 - D_f^2); A_f = \frac{\Pi}{4} D_f^2 \text{ and } R_{eb} = \frac{A_o}{A_f} = \left(\frac{D_o^2 - D_f^2}{D_f^2} \right) = \frac{D_o^2}{D_f^2} - 1 = R_e - 1.$$

c) **Direct round tube extrusion:**

$$p_{et}^* = 1.5 \frac{K}{1+n} (\bar{\epsilon})^{n+1} = 1.5 \frac{K}{1+n} (\ln R_{et})^{n+1} = 1.5 \frac{K}{1+n} \left(\ln \frac{A_o}{A_f} \right)^{n+1} \text{ Where}$$

$$A_o = \frac{\Pi}{4} (D_o^2 - D_p^2); A_f = \frac{\Pi}{4} (D_f^2 - D_p^2); R_{et} = \frac{A_o}{A_f}, \text{ where } D_p \text{ mandrel diameter.}$$

d) **Indirect round tube extrusion:**

$$p_{etb}^* = 1.5 \frac{K}{1+n} (\bar{\epsilon})^{n+1} = 1.5 \frac{K}{1+n} (\ln R_e)^{n+1} = 1.5 \frac{K}{1+n} \left(\ln \frac{A_o}{A_f} \right)^{n+1}$$

$$\text{Where } A_o = \frac{\Pi}{4} (D_o^2 - D_f^2); A_f = \frac{\Pi}{4} (D_f^2 - D_p^2); R_{etb} = \frac{A_o}{A_f} = R_{et} - 1$$

e) **Can extrusion:** $p_{ec}^* = 1.5 \frac{K}{1+n} (\bar{\epsilon})^{n+1} = 1.5 \frac{K}{1+n} (\ln R_{ec})^{n+1} = 1.5 \frac{K}{1+n} \left(\ln \frac{A_o}{A_f} \right)^{n+1}$

$$\text{Where } A_o = \frac{\Pi}{4} (D_p^2); A_f = \frac{\Pi}{4} (D_o^2 - D_p^2); R_{ec} = \frac{A_o}{A_f} > 1.$$

In general, extrusion pressure is expressed as:

$$p_{process}^* = 1.5 \frac{K}{1+n} (\bar{\epsilon})^{n+1} = 1.5 \frac{K}{1+n} (\ln R_{process})^{n+1} = 1.5 \frac{K}{1+n} \left(\ln \frac{A_o}{A_f} \right)^{n+1}$$

Eq.5.5

The principle variables that affect the extrusion force are:

1. Type of extrusion process (direct or indirect).
2. Extrusion ratio
3. Work-piece or billet temperature.
4. The speed of deformation.
5. Friction and lubrication used to decrease friction condition.

1.2.4 Direct rod extrusion Experiment

In current experiment, Plasticine “Stone type”, will be used as extruded product.

Die Fabrication: Three dies of angle 30, 45 and 60 degrees. The cylinder and the die arrangement are made for the machine. A setup has been made to do direct extrusion of the model material, Plasticine. The extrusion experiment setup consist of a cylindrical container of external diameter 50 mm and internal diameter 40 mm of made of Steel alloy using machining process which produces an excellent surface finish to produce smooth extruded surfaces. Three dies of different die angles i.e. 30, 45 and 60 degrees are made through different manufacturing process for the better results. The dies were made from Aluminum material. The side view of the three dies (30, 45, 60 degree) respectively is shown in Fig 1.10. The top of the three dies is also shown in Fig. 1.10. The top and the front view of the die & container are shown in Fig 1.11 & Fig. 1.11.



Fig. 1.10 Side and top view of die for rod extrusion process



Fig. 1.11 Side and top view of die/container for rod extrusion process

Preparation for red, green & yellow Plasticine: The Plasticine is taken from the market and is prepared for the experiment. The billet of the material is prepared of the desired shape of the diameter 25.4 mm and the height of the 25.5 mm. Six specimens prepared to carry out rod extrusion process. Extrusion ratio keeps the same for all cases.

1.2.5 Experiment Objectives:

- Three experiments to be done to study the effect of extrusion die angle on extrusion load at constant extrusion speed and extrusion ratio.
- Three extrusion speed where also selected to study the variation of load with extrusion speed, at constant extrusion die angle and extrusion ratio.
- All experimental set-up will be done using Instron tensile loading machine.

1.2.6 Experiment set-up tasks:

- Step : 1.** Prepare the Plasticine samples 25.4mm diameter x 25.4mm length.
- Step : 2.** Set the two upset flat plate jaws on the Instron, and place the extrusion set-up on the lower surface of the flat jaw.
- Step : 3.** Place the extrusion die set with angle of 30 degree in the lower part of the extrusion container. Followed place the Plasticine specimen “Billet” in extrusion container.
- Step : 4.** Carry out the loading conditions speed of 1 mm/min for billet length of 20 mm and report the Load/displacement curve.
- Step : 5.** Repeat step 3 and 4 for die angle of 45 and 60 degrees.
- Step : 6.** Report the minimum extrusion load for three cases.
- Step : 7.** Report extrusion die angle for minimum extrusion load, and repeat the experiment for three different extrusion speed “1, 2 and 3 mm/min”.
- Step : 8.** Report the results in table form and draw your conclusions.

Unit 2: Casting Experiments

2.1 Sand Casting Process Experiment

2.1.1 Introduction to Sand Casting processes

Definition of casting process: In casting process, the liquid material is poured into a cavity (mold cavity) that corresponds to the desired geometry. The shape obtained in liquid state is stabilized usually by solidification and then removed from the mold as solid-state component. Usually machining and drifting allowances are also considered in mold design. Casting is the oldest known process to manufacture metallic and non-metallic complements. For example, it is applied for metals, plastic, porcelain, ..etc.

A "foundry" term usually applied to the collection of necessary material, tools and equipments required to produce castings. Furthermore, "foundryman" term also applied to people produce castings.

Definition of sand casting processes: In sand casting the molten metal is poured into apre- prepared sand mold, dimensioned, and contoured to match the desired casting. Internal shapes in castings are obtained by placing backed core/cores consisting of silica sand and a binder in the mold cavity. The molten metal is poured into the pouring basin and flows to the mold cavity through a gate or system of gates. After filling the mold cavity, the melt enters the risers, which act as a reservoir of excess metal to compensate for shrinkage during solidification. A new mold must be made for each casting. The mold box can be designde to manufacture multiple components to increase productivity.

Molding sand: the fundamental requirements of sand is to resist high temperature, strength to retain the mold shape, withstanding the mechanical load from liquid metal, permeability (to permit the escape of gases, and collapsibility (to permit shrinkage).

Molding sand consists of :

1. *Sand material* (resist the high temperature and permeability), commonly used are silica (SiO_2) or quartz sand (cheaper). Olivine sand also used for steel castings, Zircon and synthetic sands also used but more expensive.
2. *The binder* (give the strength), e.g. Clay (bentonite, kaolin, .), Cement, Sodium silicate (for CO_2 process), Oil, Resin (shell molding).

3. *Additives* (gives collapsibility).
4. *Water* 4-8% (to activate the binder).

Sometimes the mold is baked in oven 100-300C, for several hours to obtain dry sand that helps reduce gas holes, blows or porosity in castings.

Sand mold production: the common method of producing a sand mold is through using a top flask (called cope), and a bottom flask (called drag). To improve productivity of this molding technique, different molding machines were developed to provide vibration compression and shaking on both cope and drag of sand mold to produce uniform mold strength. Fig. 2.1 shows the traditional molding technique using cope and drag and a split patterns.

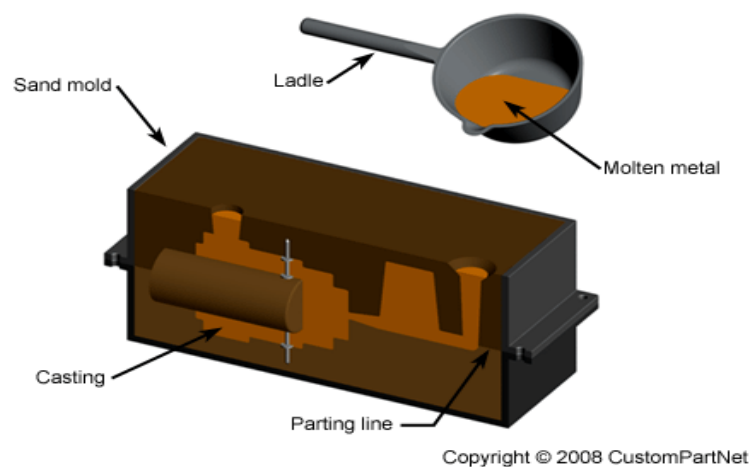
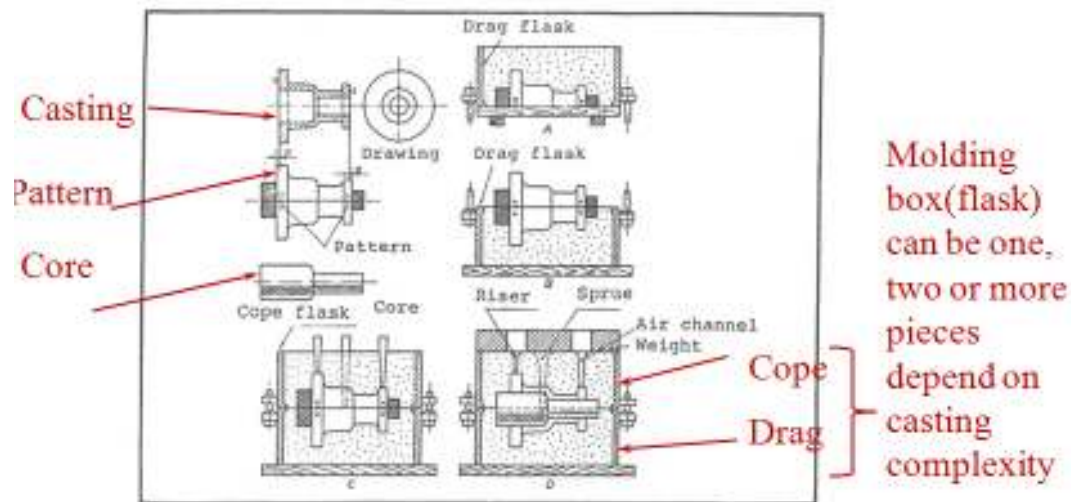

Fig. 2.1 Traditional sand molding techniques using cope/drag and split pattern system.

Much effort have been made to increase mold production using flask-less molding techniques, Fig. 2.2 shows two different flask-less molding techniques.

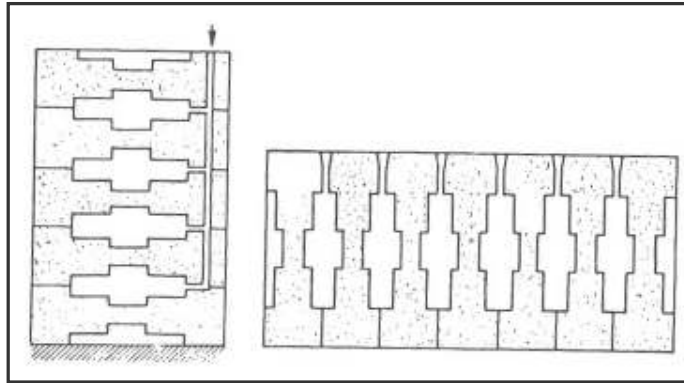

Fig. 2.2 Flask-less molding technique for used to increase the production of sand molds.

Applications: Sand casing is a common method of producing relatively cheap complements made of steel, casting, brass, aluminum, ..etc. Numerous molding techniques employ sands to produce sand molds, e.g. green sand molding (commonly used), dry sand molding (similar to green sand molding but baked sand), core sand molding, shell sand molding, ..etc. The typical component weight is in the range of 500 grams to 50 Kg or even several tons e.g. machine tool frames. Wall thickness generally between 5 to 50 mm. Example products are engine blocks, crankshafts, connected rods, machine bed, turbine housing, ..etc. Sand casing produce rough surfaces, and lower dimensional accuracy compared to other casting processes, hence, machining is required for those castings. Machining and drift allowances must be considered in pattern design.

Machinery: Equipment consists of pattern, which usually manufactured form wood (low production batch), plastics (e.g. thermosetting plastic) and metals (for long live pattern and high production rate). Flask and flask-less molding techniques are used to manufacture sand mold. Core equipment also used to produce cores for the internal shape of components.

2.1.2 Sand casting Processes

1) Green sand molding

See previous section. Commonly used for making cope and drag sand molding process.

2) Shell mold casting

Definition: In shell mold casting, which is a type of sand mold casting, the mold produced from dried silica sand (fine and sharp) mixed with a thermosetting resin (phenolic).

Shell mold preparation: Summary of molding steps are given as follows, (see Fig. 2.3):

- An accurate metal pattern is heated to 150-250C, and the sand mixture is dumped on the pattern, which is placed in mold box. After a few minutes, a layer of the sand mixture is cured, and the excess mixture is removed by inverting the mold box.
- The pattern and the partially cured shell are baked in an oven for a few minutes to complete the curing process.
- The pattern and shell are now separated, and the mold halves assembled with clamps, glue, or other devices. The shell mold is placed in a pouring jacket and backed up or supported by shot or sand and sometimes using supported pins.
- After mold production, molten metal is poured in the mold and the metal solidified. The component is obtained by breaking the mold. For high production multiple pattern plate may design to have multiple patterns. Furthermore, for high production the pattern plate is designed to have gating and sprue system.

Applications: Shell mold casting offers greater dimension accuracy and better surface finish than the green sand casting process. Also, it offers sharp corners, internal shape contour, small holes, ..etc. Hence, accurate castings can be produced using this method. Sometimes, cores are produced using shell molding while the mold is produced using green sand mold technique, to obtain accurate internal shapes of castings, e.g. water pump and compressor casing components. The disadvantage of this molding technique, is the initial cost of the tooling system. For example, air-cooled combustion engines are produced using shell mold casting. An average weight of the components range between 10 to 20 Kg. Commonly used to manufacture core

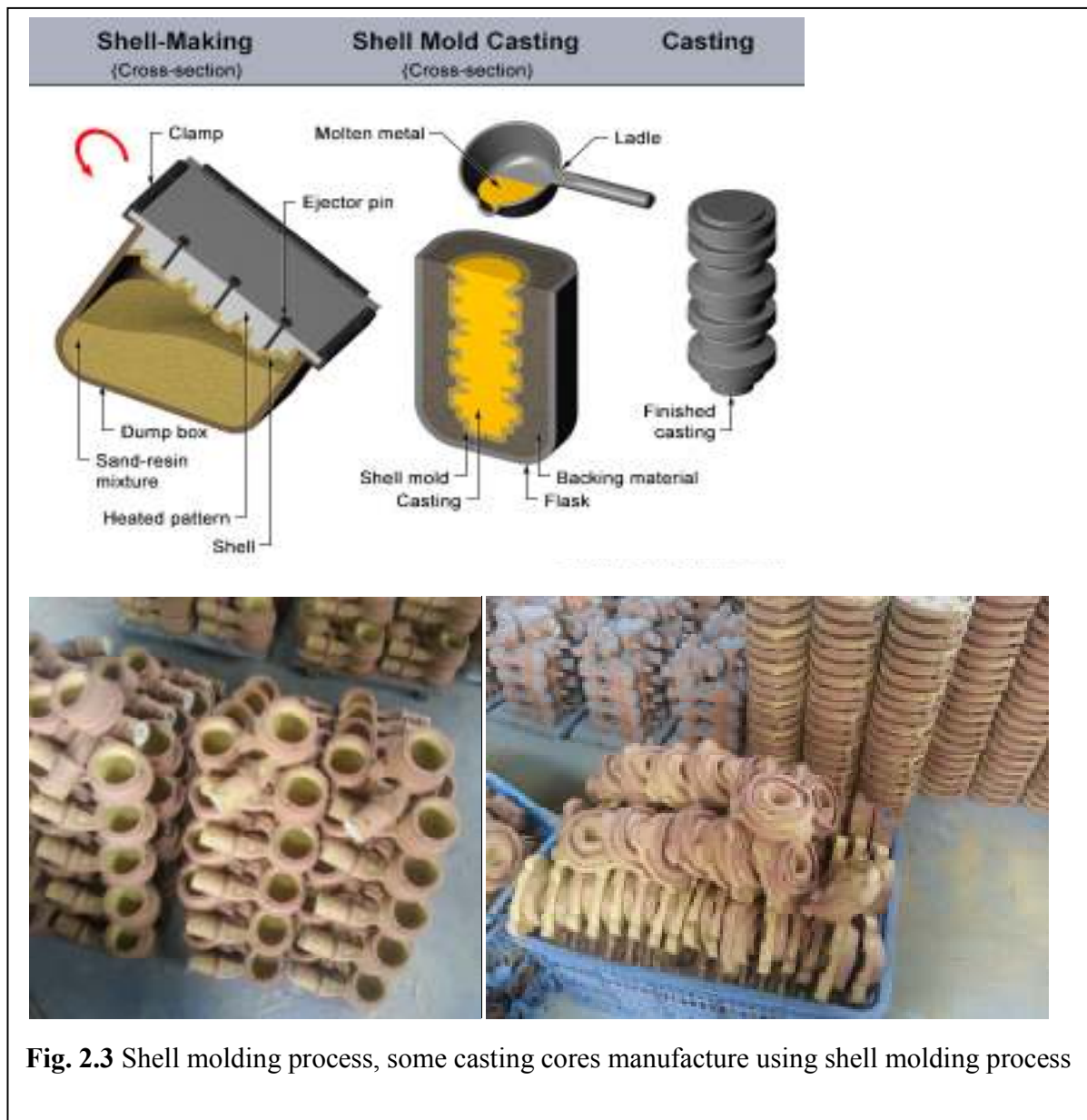

Fig. 2.3 Shell molding process, some casting cores manufacture using shell molding process

Machinery: Equipment consists of metal pattern mounted on the pattern plate including runner, gate and sprue system. Heating oven, flask and metal or sand shot. Sometimes, electric heating elements are inserted in the pattern plate to control the temperature driven using temperature controller system, also automatic injectors may be used to automate the process and increase productivity.

3) Sodium silicate (Na_2SiO_3) sand molding

Definition:

Instead of using an oil or resin that requires heat for bonding or curing like shell molding process. It is one of the easiest modern core making processes for instructional and small foundries to use is the sodium silicate “ CO_2 process”. The sand is rammed into a core box and cured by passing CO_2 through the core. Sodium silicate cores are very strong. It is process in which the silica sand is mixed with sodium silicate with 3% weight ratio.

Application: common used in producing core, see Fig 2.4.



Fig 2.4 Sodium silicate core making process

4) Investment casting

Definition: A process in which the molten metal is poured into a preheated mold made by means of a disposable pattern of wax or plastic coated with a thin layer of silica, plaster, or ceramic. It is also known as the lost wax process. This process is one of the oldest manufacturing processes. The Egyptians used it in the time of the Pharaohs to make gold jewelry (hence the name Investment) some 5,000 years ago.

Mold preparation: Before casting the pattern is melted by warming the mold and then inverted to allow the wax to flow out. The molding steps are shown in Fig. 2.5. Summary of molding stages are as follows:

- Production of master pattern (from metal or wood), which is required to produce the master die for wax pattern.

- Production of wax patterns by pouring or injection of wax into the master die.
- Assembling the pattern assembly with a thin layer of investment material (dipping in a thin slurry of fine-grained silica).
- Production of final investment by placing the coated pattern assembly into flask and pouring investment material around.
- Drying and hardening for several hours.
- Melting the wax pattern assembly by warming the mold and inverting it to allow the wax to flow out.
- Heating the mold to higher temperatures (850-1000C), to drive off moisture.
- Preheating the mold to 500-1000C to assist the flow of molten metal to thin sections and to obtain accurate part geometry.
- Pouring the molten metal, either by gravity, or pressure.
- Removal of castings after solidification by breaking the mold.

Summary of molding procedure is shown in Fig. 2.5.

Applications: In investment casting no draft allowance is required and very complex shape, e.g. pump impellers, compressor diffusers, turbine plates or wheels, etc., are common components produced using investment casting. Therefore, the part complex geometry is limitless in case of investment casting process. Investment casting applied for both ferrous and non-ferrous metals also used to manufacture metals difficult to machine or un-machinable metals e.g. radioactive metals. Hence, an accurate components are produced with tolerances of $\pm 0.075\%$ for components having dimensions up to 15 mm. Low surface roughness is obtained using investment casting (1.5-3 Ra).

Machinery: Equipment for producing the ceramic mold consists of slurry tank, baking oven. The equipment for making the wax pattern are also needed.

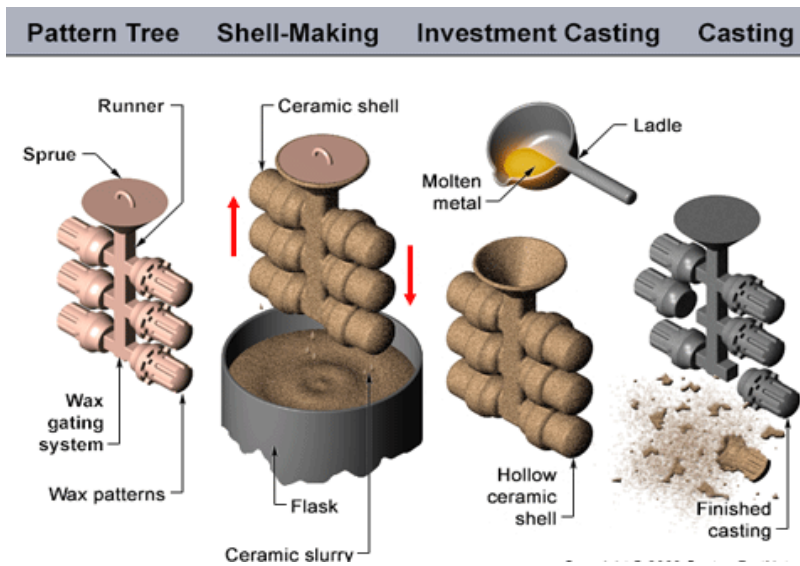

Fig 2.5 Procedure of mold preparation on investment casting. Stock of investment castings.

2.1.3 Core making consideration and core box manufacturing

Core mainly used to create the internal cavities in castings. But also can be used to create complicated external casting surfaces. Single core may be used for castings with simple internal cavity. When casting has complicated internal cavities, e.g. Engine block

castings, multiple core can be used and can be assembled together to form a big core for a given casting cavity.

Mainly two types of core boxes are available, cold and hot box types. Cold box is commonly used for manufacturing cores using oils mixture as bonding material after cooked in oven, and also core manufacture using CO₂ process “sodium silicate process”. Commonly cold core box manufactured either wood, for small quantities, or aluminum alloy. Hot box commonly used when the core cooked inside the core, either by electric heaters or gas cooking heat. Shell molding process commonly used to manufacture cores using hot box core process. Hot box manufactured from hot tool steel, for long production, or cast iron metals for medium production capacity. Fig 2.6, shows some illustrated big and small core boxed, cold and hot type.



Fig 2.6 Cold split core box for big pump casing.

2.1.4 Pouring system in mold

One important factor that effect obtaining castings without defects, pouring system in mold design either in permanent or non-permanent mold. Pouring molten metal in mold cavity achieved either at high pressure (2-15 Mpa), low pressure (0.12 to 0.3 Mpa), or without pressure (gravity) technique. For higher quality and thinner sections, high pressure pouring technique is recommended. The molten metal is poured initially in pouring basin (common for large mold to prevent slag getting in) through the sprue in case of gravity pouring technique (see Fig. 2.1).

The molten metal will flow from spur to runner, then to gating system and finally to mold cavity and riser. It is worth noting that poor design of runner; gating and riser systems may result in defect castings.

Sprue is usually tapered by 2 ° at the end bottom of mold for higher flow and reduction of air aspiration.

More than one gate may required in mold gating system design especially with large castings. As a general design rule, the sprue cross-sectional area should be sized 20% larger than the total cross-section areas of the gate/gates system.

2.1.5 Riser consideration in mold design

When designing mold cavity and gating system, metal shrinkage must be considered in mold cavity design. For example, the solidification shrinkage is between 6-7% for aluminum, while it is between 1.9 to 2.5% for cast iron, for more information on mold gating design refer to literature.

From cooling curve of metal and alloys background, there is a single melting point when metal is poured, while there are melting ranges in case of alloys, see Fig 2.6. Volume shrinkage is not important for both liquid and solid metals, while it becomes serious for mixed solid and molten metal (during the solidification range), which result in cracks in castings.

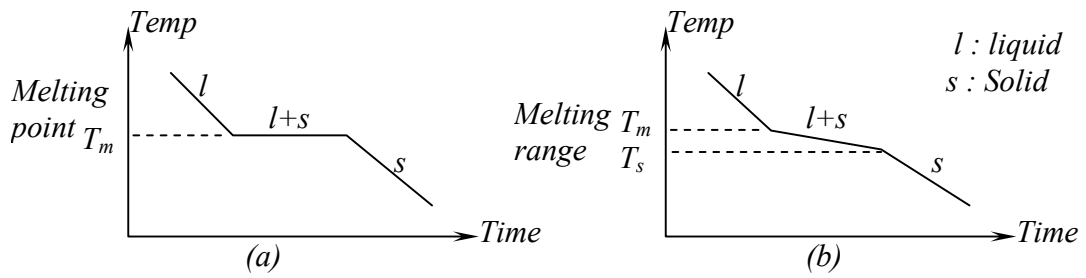

Fig. 2.6 Cooling curve for pure metal (a) and alloys (b).

To compensate for shrinkage during cooling from the pouring temperature to solidification, a reservoir of molten metal should be attached to casting (riser). For shrinkage compensation, the reservoir or riser must be solidified after component solidification. Fig. 2.7, solidification procedure of cube of molten metal with and without reservoir (riser) of molten metal.

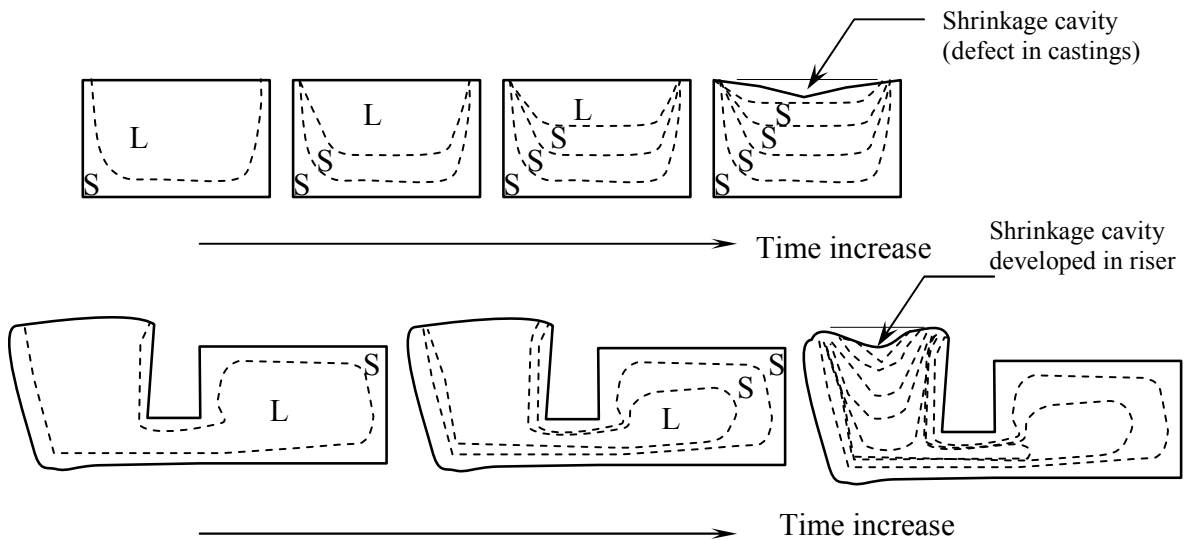

Fig. 2.7 Solidification of molten metal cube with and without riser consideration.

For proper riser design, the following requirement must be achieved:

- Solidification time of riser is greater than the solidification time of casting ($t_{riser} > t_{casting}$).
- Enough feed of metal.
- Proper location (near the thickest section).

2.1.6 Sand casting experiment

Experiment Objective:

- Main objective of current experiment, identify main tools used in green sand molding process, see Fig 2.8.
- Identify the main steps required to manufacture green sand mold.
- Manufacture simple pipe casting using split pattern and core box.



Fig. 2.8 Given green sand molding tools and equipment at the Industrial Engineering Department, “flakes, electric furnace, pattern and core box, and sand mixer/miller,.

2.1.7 Sand casting tests

Background on sand molding:

Sand used in foundries must be capable of with-standing very high temperatures and shouldn't collapse under the prevailing load. Silica sand is mostly used in foundries because of the following.

- It is a very good refractory material and doesn't fuse or soften even at very high temperatures, i.e. 1650°C, when in contact with molten metal.
- They can be easily molded into intricate shapes.
- They have sufficient porosity or permeability and allow easy escape of gases produced by molten metal and other bonding constituent.
- They can be used repeatedly for making molds after addition of some bonding materials.
- They are cheap and easily available.
- They are chemically immune to molten metals.

Sources of Molding Sand Molding: Sand used in foundries is available in (i) River beds. (ii) Sea. (iii) Deserts. (iv) Lakes.

Types of Molding Sand: Depending upon the purity and other constituents present, sand is classified into (i) Natural sand. (ii) Synthetic sand, (iii) loam sand.

Natural sand is directly used for molding and contains 5-20% of clay as binding material. It needs 5-8% water for mixing before making the mold. Its main drawback is that it is less refractory as compared to synthetic sand.

Synthetic sand consists of silica sand with or without clay, binder or moisture. It is a formulated sand i.e. sand formed by adding different ingredients. Sand formulations are done to get certain desired properties not possessed by natural sand. These sands have better casting properties like permeability and refractoriness and are suitable for casting ferrous and non-ferrous materials. These properties can be controlled by mixing different ingredients. Synthetic sands are used for making heavy castings.

Loam sand contains many ingredients, like fine sand particles, finely ground refractories, clay, graphite and fiber reinforcements. In many cases, the clay content may be of the order of 50% or more. When mixed with water, the materials mix to a consistency resembling mortar and become hard after drying. Big molds for casting are made of brick framework lined with loam sand and dried.

Refractory sand grains size: Sand grain size and shape has a marked effect on the properties of molding sand. Many properties of molding sand like permeability, adhesiveness, surface fineness, strength. etc, depend upon the grain size and distribution of sand particles. The finer the grain size, the finer is the sand as a whole. Finely grained sand gives a good surface finish but possesses low permeability. Coarse grained sand gives lesser surface finish but imparts good flow ability, good refractoriness and good permeability.

Binders used in sand molding: Binders are added to give cohesion to molding sands. Binders provide strength to the molding sand and enable it to retain its shape as mold cavity. Binders should be added in optimum quantity as they reduce refractoriness and permeability. An optimal quantity of binders is needed, as further increases have no effect on properties of foundry sand.

The following binders are generally added to foundry sand:

(i) Fireclay

(ii) Illite

(iii) Bentonite

Sodium montmorillonite

Calcium montmorillonite

(iv) Limonite

(iv) Kaolinite

(i) Fireclay : It is usually found near coal mines. For use in the foundry, the hard black lumps of fireclay are taken out, weathered and pulverized. Since the size of fireclay particles is nearly 400 times greater than the size of bentonite particles, they give poor bonding strength to foundry sand.

(ii) Illite: Illite is found in natural molding sands that are formed by the decomposition of micaceous materials due to weathering. Illite possesses moderate shrinkage and poor bonding strength than bentonite.

(iii) Bentonite: It is the most suitable material used in molding sands.

Limonite and Kaolinite are not commonly used as binders as they have comparatively low binding properties.

Kinds of molding sand: Molding sands can also be classified according to their use into number of varieties which are described below.

- *Green sand*

Green sand is also known as tempered or natural sand which is a just prepared mixture of silica sand with 18 to 30 percent clay, having moisture content from 6 to 8%. The clay and water furnish the bond for green sand. It is fine, soft, light, and porous. Green sand is damp, when squeezed in the hand and it retains the shape and the impression to give to it under pressure. Molds prepared by this sand are not requiring backing and hence are known as green sand molds. This sand is easily available and it possesses low cost. It is commonly employed for production of ferrous and non-ferrous castings.

- *Dry sand*

Green sand that has been dried or baked in suitable oven after the making mold and cores, is called dry sand. It possesses more strength, rigidity and thermal stability. It is mainly suitable for larger castings. Mold prepared in this sand are known as dry sand molds.

- *Loam sand*

Loam is mixture of sand and clay with water to a thin plastic paste. Loam sand possesses high clay as much as 30-50% and 18% water. Patterns are not used for loam molding and shape is given to mold by sweeps. This is particularly employed for loam molding used for large grey iron castings.

- *Facing sand*

Facing sand is just prepared and forms the face of the mold, gives surface finish to casting. It is directly next to the surface of the pattern and it comes into contact molten metal when the mold is poured. Initial coating around the pattern and hence for mold surface is given by this sand. This sand is subjected severest conditions and must possess, therefore, high strength refractoriness. It is made of silica sand and clay, without the use of used sand.

- *Backing sand*

Backing sand or floor sand is used to back up the facing sand and is used to fill the whole volume of the molding flask. Used molding sand is mainly employed for this purpose. The backing sand is sometimes called black sand because that old, repeatedly used

molding sand is black in color due to addition of coal dust and burning on coming in contact with the molten metal.

- *Parting sand*

Parting sand without binder and moisture is used to keep the green sand not to stick to the pattern and also to allow the sand on the parting surface the cope and drag to separate without clinging.

- *Core sand*

Core sand is used for making cores and it is sometimes also known as oil sand. This is highly rich silica sand mixed with oil binders such as core oil which composed of linseed oil, resin, light mineral oil and other bind materials.

Sand Molding Properties

The basic properties required in molding sand and core sand are described as under.

- *Refractoriness* Refractoriness is defined as the ability of molding sand to withstand high temperatures without breaking down or fusing thus facilitating to get sound casting.
- *Permeability* It is also termed as porosity of the molding sand in order to allow the escape of any air, gases or moisture present or generated in the mold when the molten metal is poured into it. All these gaseous generated during pouring and solidification process must escape otherwise the casting becomes defective. Permeability is a function of grain size, grain shape, and moisture and clay contents in the molding sand. Permeability of mold can be further increased by venting using vent rods
- *Cohesiveness* It is property of molding sand by virtue which the sand grain particles interact and attract each other within the molding sand. Thus, the binding capability of the molding sand gets enhanced to increase the green, dry and hot strength property of molding and core sand.
- *Green strength* The green sand after water has been mixed into it, must have sufficient strength and toughness to permit the making and handling of the mold. For this, the sand grains must be adhesive, i.e. they must be capable of attaching themselves to another body and. therefore, and sand grains having high adhesiveness will cling to the sides of the molding box. The green strength also depends upon the grain shape and size, amount and type of clay and the moisture content.

- *Dry strength* As soon as the molten metal is poured into the mold, the moisture in the sand layer adjacent to the hot metal gets evaporated and this dry sand layer must have sufficient strength to its shape in order to avoid erosion of mold wall during the flow of molten metal.
- *Flowability or plasticity* It is the ability of the sand to get compacted and behave like a fluid. It will flow uniformly to all portions of pattern when rammed and distribute the ramming pressure evenly all around in all directions. Generally sand particles resist moving around corners or projections. In general, flow ability increases with decrease in green strength, an, decrease in grain size. The flow ability also varies with moisture and clay content.
- *Collapsibility*: After the molten metal in the mold gets solidified, the sand mold must be collapsible so that free contraction of the metal occurs and this would naturally avoid the tearing or cracking of the contracting metal. In absence of this property the contraction of the metal is hindered by the mold and thus results in tears and cracks in the casting. This property is highly desired in cores.

Sand testing:

Generally the following tests are performed to judge the molding and casting characteristics of foundry sands:

1. Moisture content Test
2. Clay content Test
3. Chemical composition of sand
4. Grain shape and surface texture of sand.
5. Grain size distribution of sand
6. Refractoriness of sand
7. Strength Test
8. Permeability Test
9. Flowability Test
10. Shatter index Test
11. Mould hardness Test.

2.1.8 Sand casting test experiments

Experiment Objectives

- Study the effect of sand permeability for three sand-bind mixing ratios, 20, 25 and 30%.
- Study the strength of the green sand molding for the given three sand-bind mixing ratios
- Moisture percent kept the same for all experimental tests.

Equipment given in experiment, see Fig 2.9:

- Permeability sand meter.
- Sand strength meter (compression test, tensile test, shear test)
- Laboratory sand rammer (type N) for sand sample preparation.
- Scale for weight.
- Heating oven.
- Die set for specimen preparation.

Equipment given in experiments



Fig 2.9 list of equipment and instrumentation used in sand tests