

DRAW AN ISOMETRIC

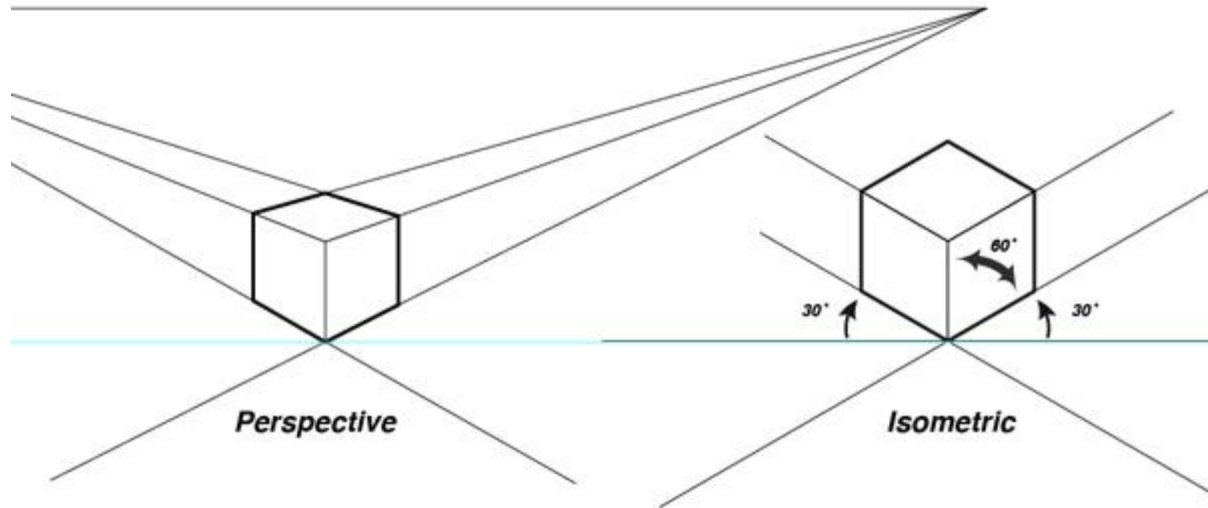

Perspective

Isometric

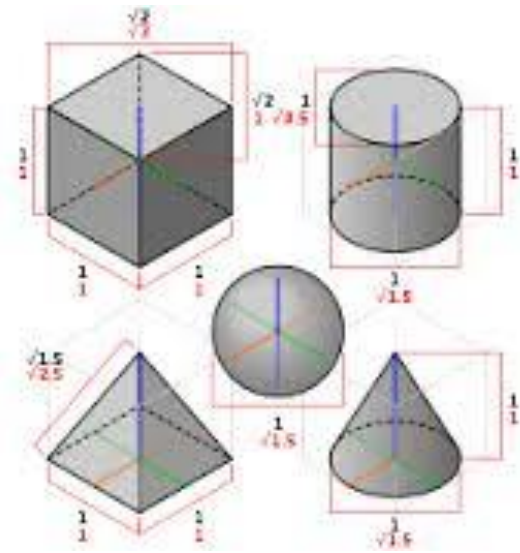
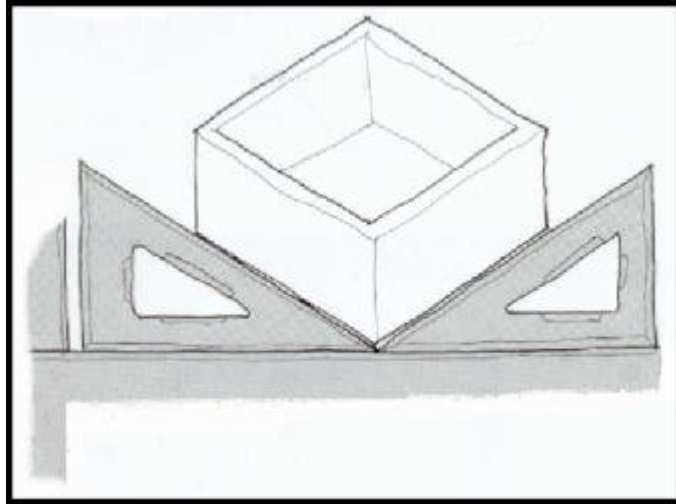

STEP 1



STEP 2

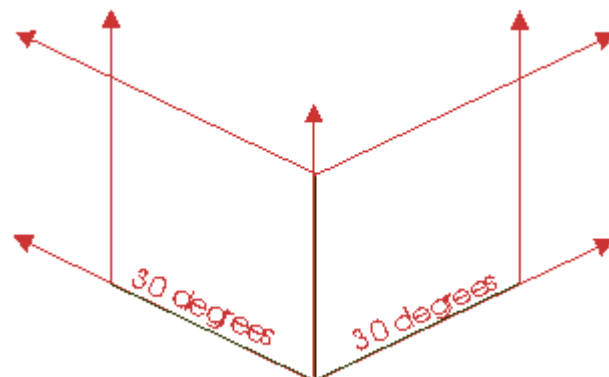

STEP 3

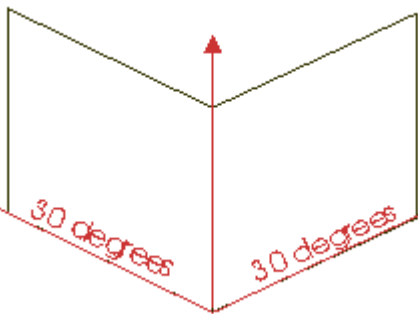
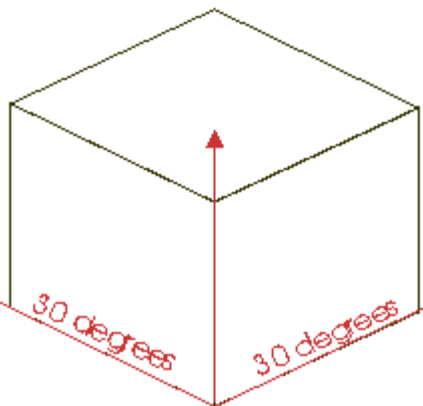

STEP 4

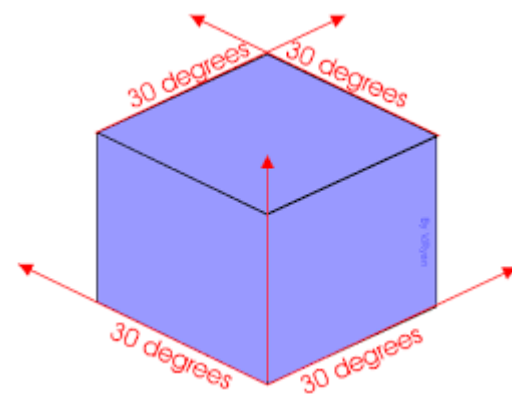
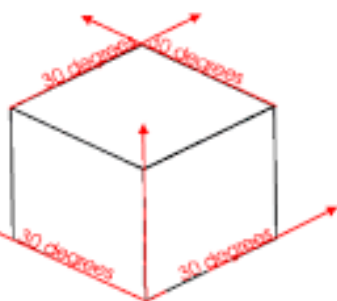
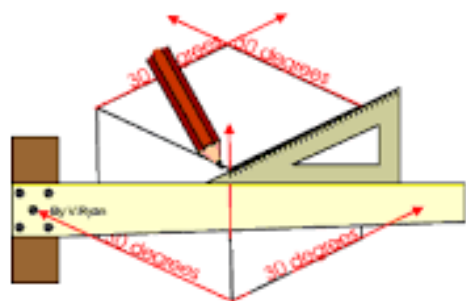
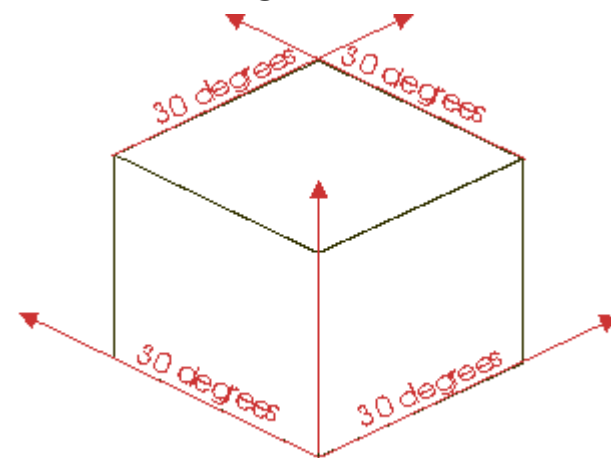

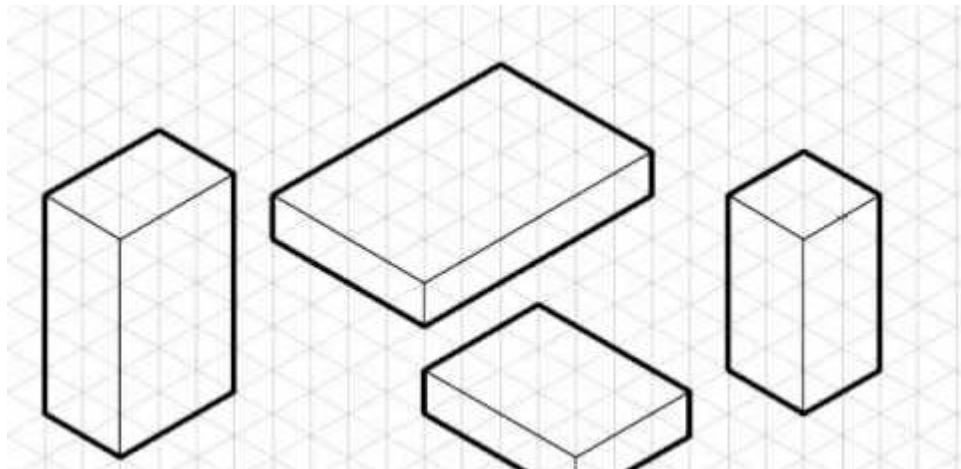
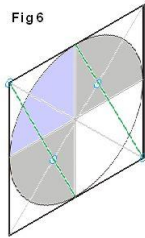
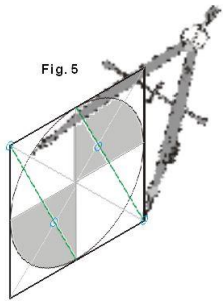
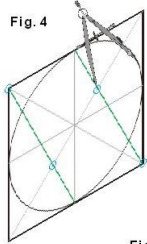
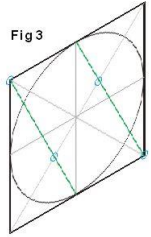
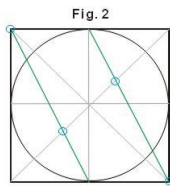
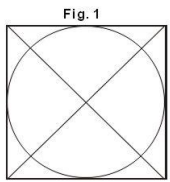

ISOMETRIC DRAWING - CUBES

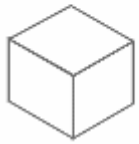

STEP 1

By V.Ryan



By V.Ryan

STEP 2

By V.Ryan

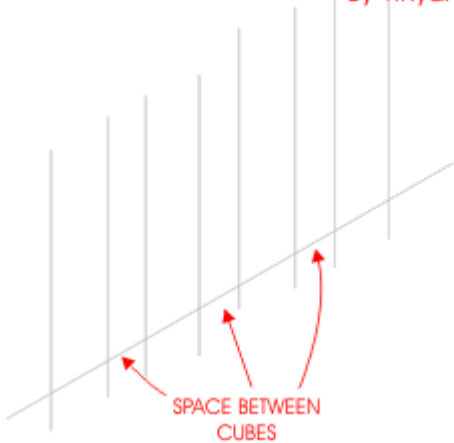

SPACE BETWEEN
CUBES

STEP 3



By V.Ryan

STEP 4



By V.Ryan

STEP 5



By V.Ryan

STEP 6

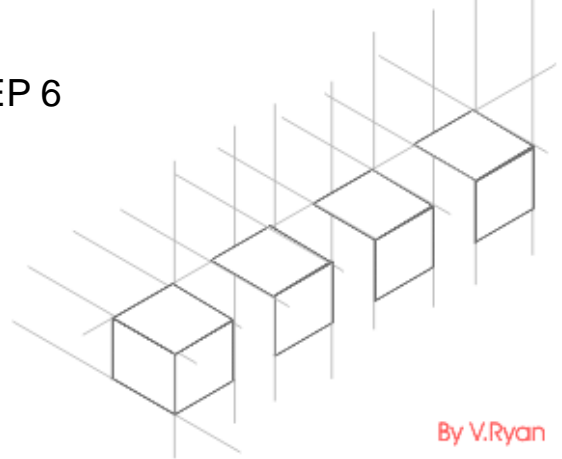

By V.Ryan

STEP 7

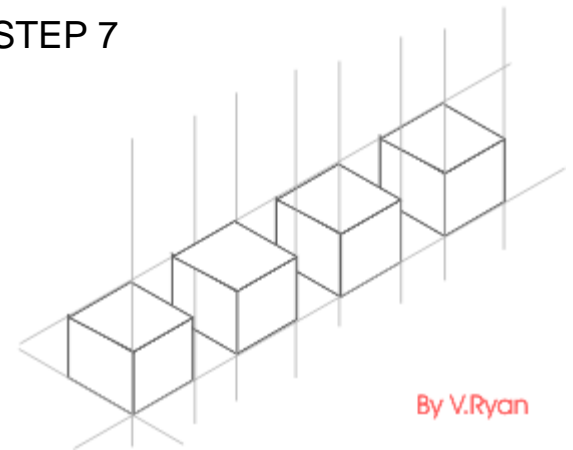

By V.Ryan

Fig. 1

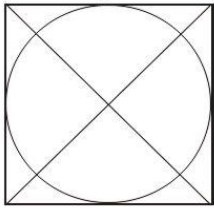

Fig. 2

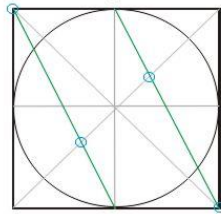

Fig. 3

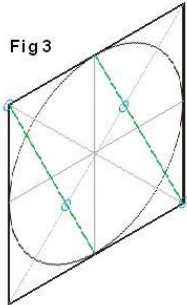

Fig. 4

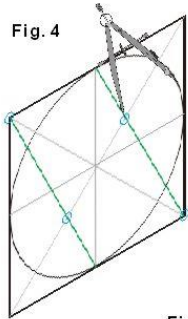

Fig. 5

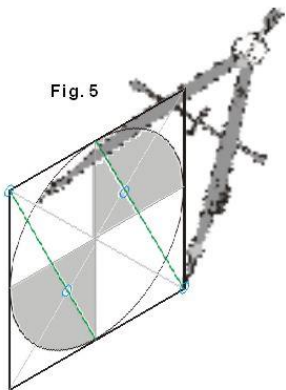

Fig. 6

