

Chapter 8

SEEPAGE

Omitted Section 8.10

SEEPAGE

One-dimensional flow

We need only Darcy's law

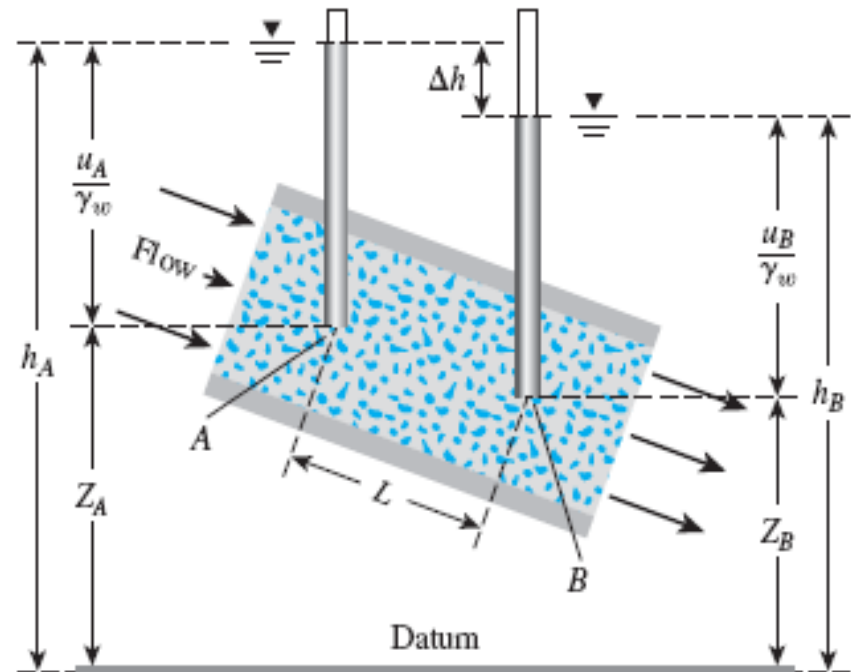
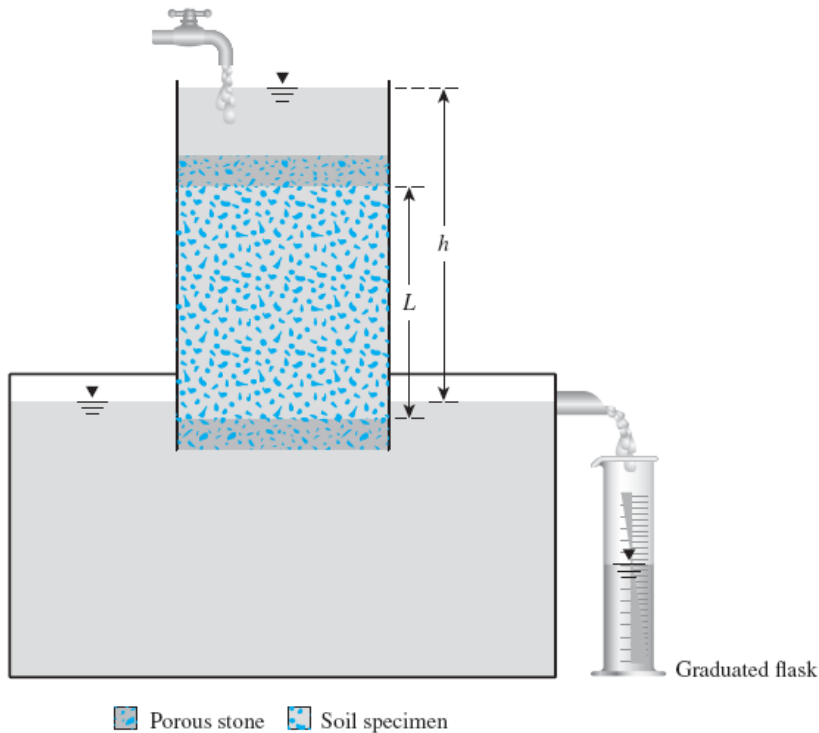

$$\text{Flow Rate} = q = v \cdot A = k \cdot i \cdot A = k \left(\frac{h}{L} \right) \cdot A$$

Total head at any point can be found through linear interpolation

SEEPAGE

Two-dimensional flow

In reality, the flow of water through soil is not in **one** direction only, nor is it **uniform** over the entire area perpendicular to the flow.

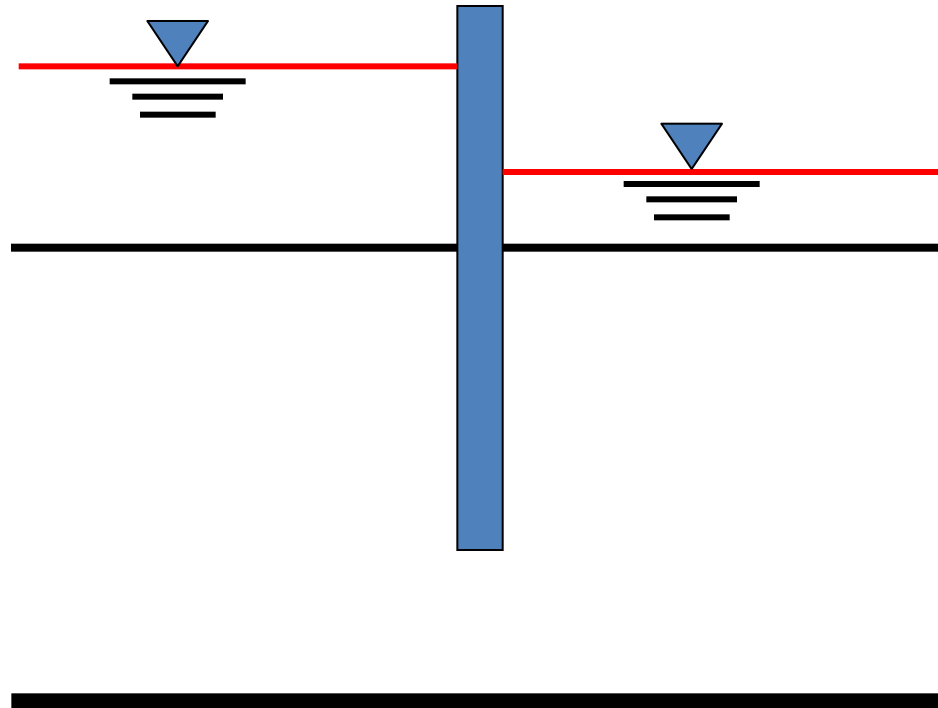

SEEPAGE

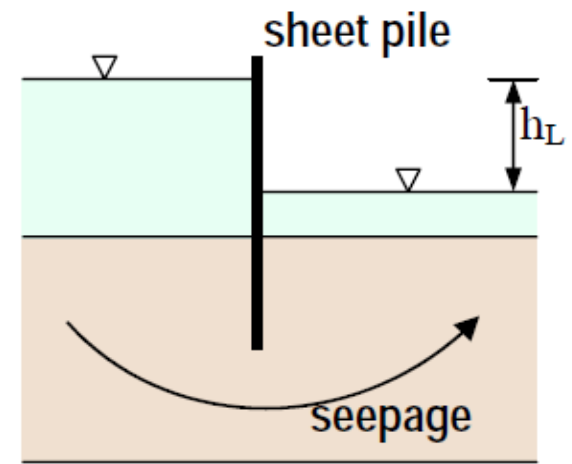
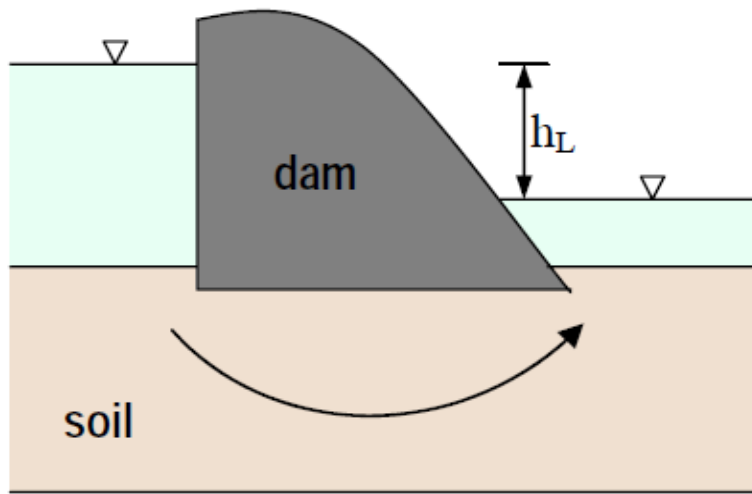

Seepage beneath (a) a concrete dam (b) a sheet pile

SEEPAGE

- In the preceding chapter the flow of water for simple 1-D is calculated through direct application of **Darcy's law** as already we did in the case of the permeability tests.
- As engineers, we will wish to examine and calculate the leakage below the sheet pile or through or beneath the dam and find the distribution of pore water pressure (p.w.p) and effective stress throughout the soil.
- If the structure (sheet pile, dam, ...etc.) is very long, we may neglect the component of flow in the 3rd dimension and consider only the flow through a **slice of unit thickness**.
- This corresponds to plane or two-dimensional flow and we will consider only this case.

SEEPAGE

- If **p.w.p** varies with time the flow will be time-dependent. This is what is so-called **non-steady** state flow or **TRANSIENT SEEPAGE**. This may be due to:
 - ✚ **External cause like change in the head difference between inlet or outlet due to any reason.**
 - ✚ **Internal cause like deformation of soil during the process of seepage.**
- In the second case there is a complex interrelationships between **p.w.p**, **seepage**, and **deformation**. This time-dependent process is known as **consolidation** and is considered in **CE 481 Geotechnical Engineering II**.

SEEPAGE

- ◉ If **p.w.p** does not vary with time, the rate of flow will be constant and the flow is known as **STEADY-STATE-SEEPAGE**.
- ◉ During steady state seepage, **p.w.p** remains **constant** and **no** soil **deformation** occur. Hence we will consider **TWO-DIMENSIONAL STEADY-STATE SEEPAGE**.
- ◉ The soil may therefore be regarded as **RIGID** and **stationary** with a steady flow of water through the pore spaces.
- ◉ Also in this course we will **mostly** consider the simple case of **CONFINED** flow, where the seepage is confined between **two** impervious surfaces, or boundaries.



Laplace's Equation of Continuity

TWO-DIMENSIONAL SEEPAGE FLOW THEORY

The hydrodynamics steady-state fluid flow through porous media follows the same basic laws as the problems of steady-state:

✚ Heat flow

✚ Current flow

In a continuous contactors

All can be represented by LAPLACE EQUATION.

In flow problems Laplace equation is the combination of the equation of continuity and Darcy's law.

Laplace's Equation of Continuity

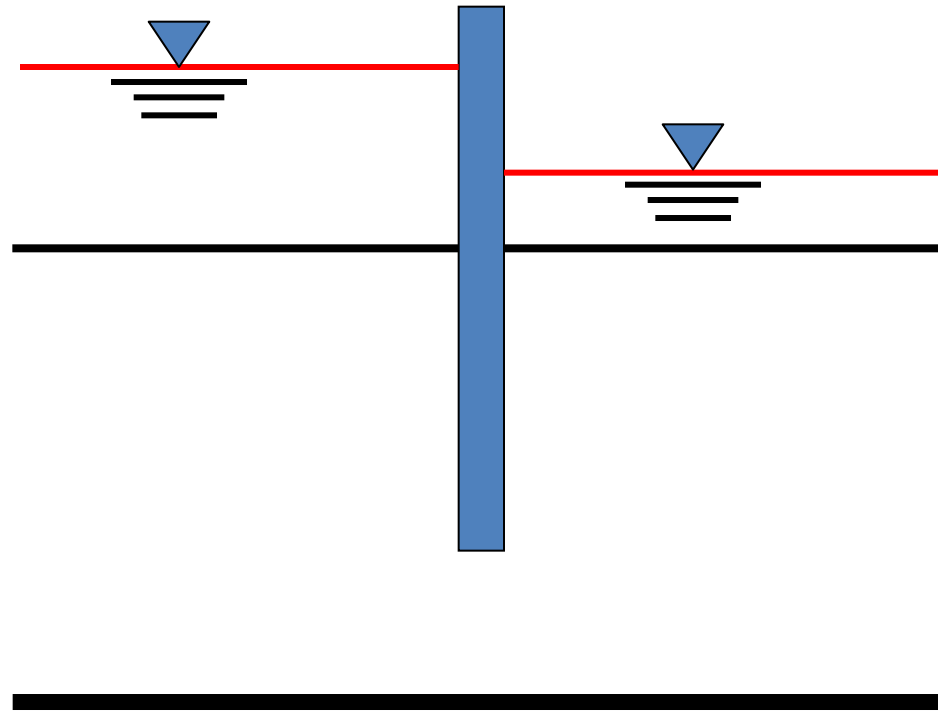

Steady-State Flow around an impervious Sheet Pile Wall

SEEPAGE

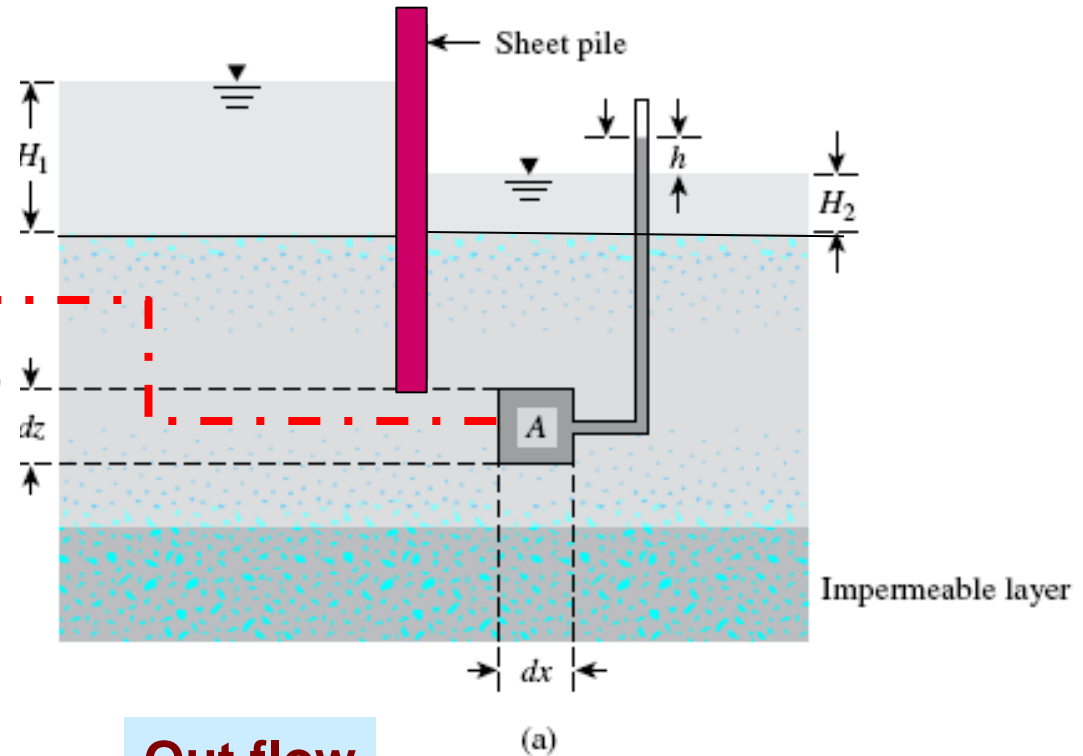
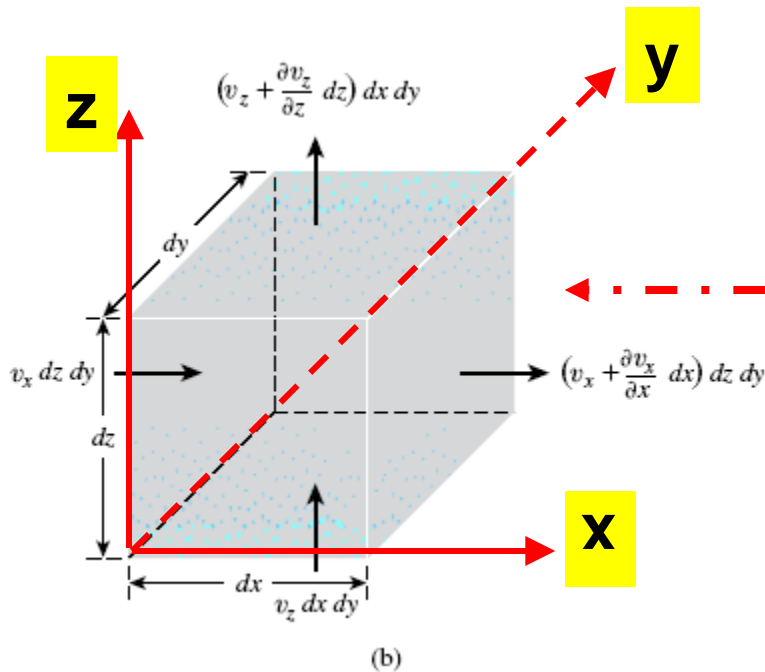

In flow

$$q_{in} = v_x \cdot dz dy \quad (\text{horizontal direction})$$

$$q_{in} = v_z \cdot dx dy \quad (\text{vertical direction})$$

Out flow

$$q_{out} = (v_x + \frac{\partial v_x}{\partial x} dx) dz dy \quad (\text{horizontal direction})$$

$$q_{out} = (v_z + \frac{\partial v_z}{\partial z} dz) dx dy \quad (\text{vertical direction})$$

SEEPAGE

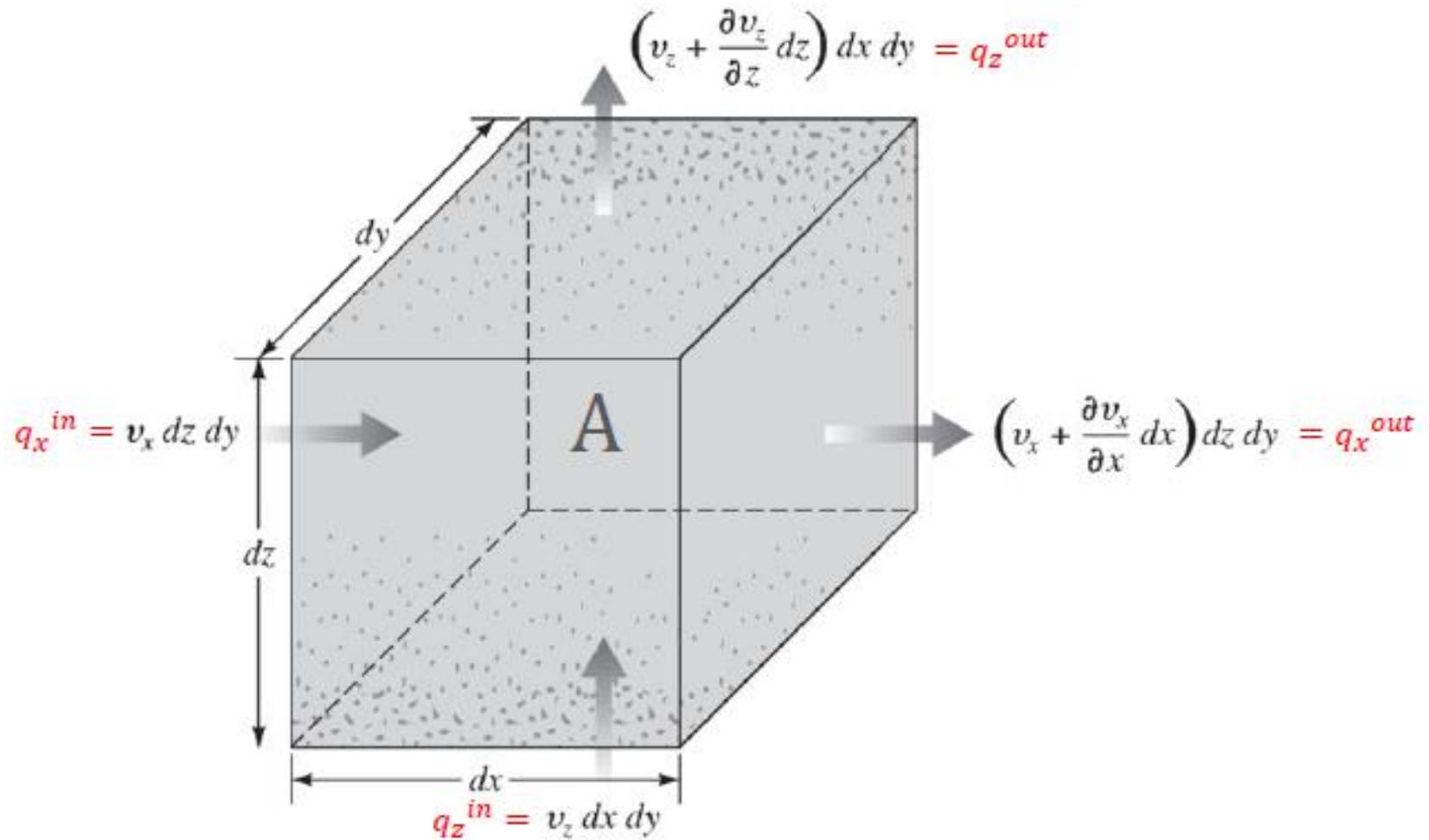

Laplace's Equation of Continuity

Total rate of inflow = Total rate of outflow

$$q_{in} = v_x \cdot dz dy \quad (\text{horizontal direction})$$

$$+ \quad q_{in} = v_z \cdot dx dy \quad (\text{vertical direction}) \quad (I)$$

$$= \quad q_{out} = \left(v_x + \frac{\partial v_x}{\partial x} dx \right) dz dy \quad (\text{horizontal direction})$$

$$+ \quad q_{out} = \left(v_z + \frac{\partial v_z}{\partial z} dz \right) dx dy \quad (\text{vertical direction})$$

$$\left[\left(v_x + \frac{\partial v_x}{\partial x} dx \right) dz dy + \left(v_z + \frac{\partial v_z}{\partial z} dz \right) dx dy \right] - [v_x dz dy + v_z dx dy] = 0 \quad (II)$$

Laplace's Equation of Continuity

$$\frac{\partial v_x}{\partial x} + \frac{\partial v_z}{\partial z} = 0 \quad (III)$$

$$v_x = k_x i_x = k_x \frac{\partial h}{\partial x} \quad v_z = k_z i_z = k_z \frac{\partial h}{\partial z} \quad (IV)$$

Substituting Eq. (IV) into Eq. (III) and assuming $k_x = k_z$

$$\frac{\partial^2 h}{\partial x^2} + \frac{\partial^2 h}{\partial z^2} = 0 \quad (V)$$

This equation governs the steady flow condition for a given point in the soil mass

Solution of Laplace's Equation

Laplace's equation can be solved using different methods. The most important are:

- **Analytical Methods**
 - Separation of variables
 - Laplace transform
 - Fourier transform
- **Numerical Methods**
 - Finite element
 - Finite difference
- **Graphical method** Flow nets [Trial-and-error sketching](#)

Solution of Laplace's Equation

- The **analytical** methods are exact, however they are **complicated** and solutions are available only for simple boundary conditions. Therefore they are less practical.
- Numerical methods vastly developed in the presence of **digital computer** and a number of solutions are now available.
- Graphical method termed **FLOW NET** is preferred by many because it is very versatile and **simple**.
- In this course we will limit discussion to **flow net** through **trial-and-error** sketching.
- By constructing the **flow net** we can know the values of **head** at any point in the soil and also find the **flow rate**.



FLOW NETS

Basis of Flow Nets

- Consider flow through the constant head permeameter shown below:

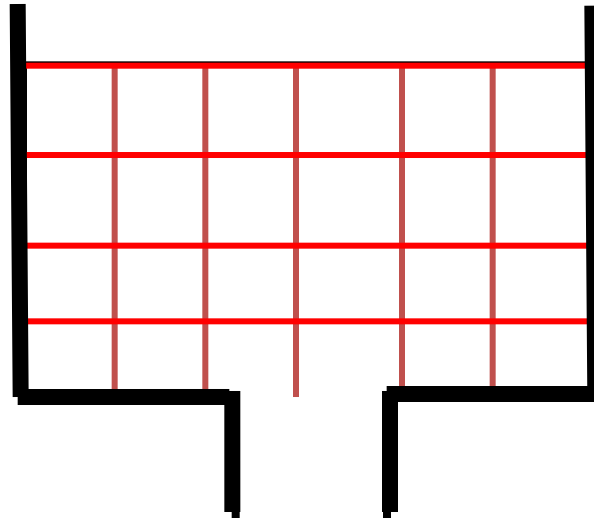

- We can see that there are two families of lines:
 - Vertical lines which represent the direction of flow of water particles.
 - Horizontal lines which represent lines of constant head.
- Note: As the water progress through the sample, head is lost at constant rate (but we deal only with steady state, i.e. h is constant)

Basis of Flow Nets

- Consider the other way around (i.e. flow is **horizontal**)

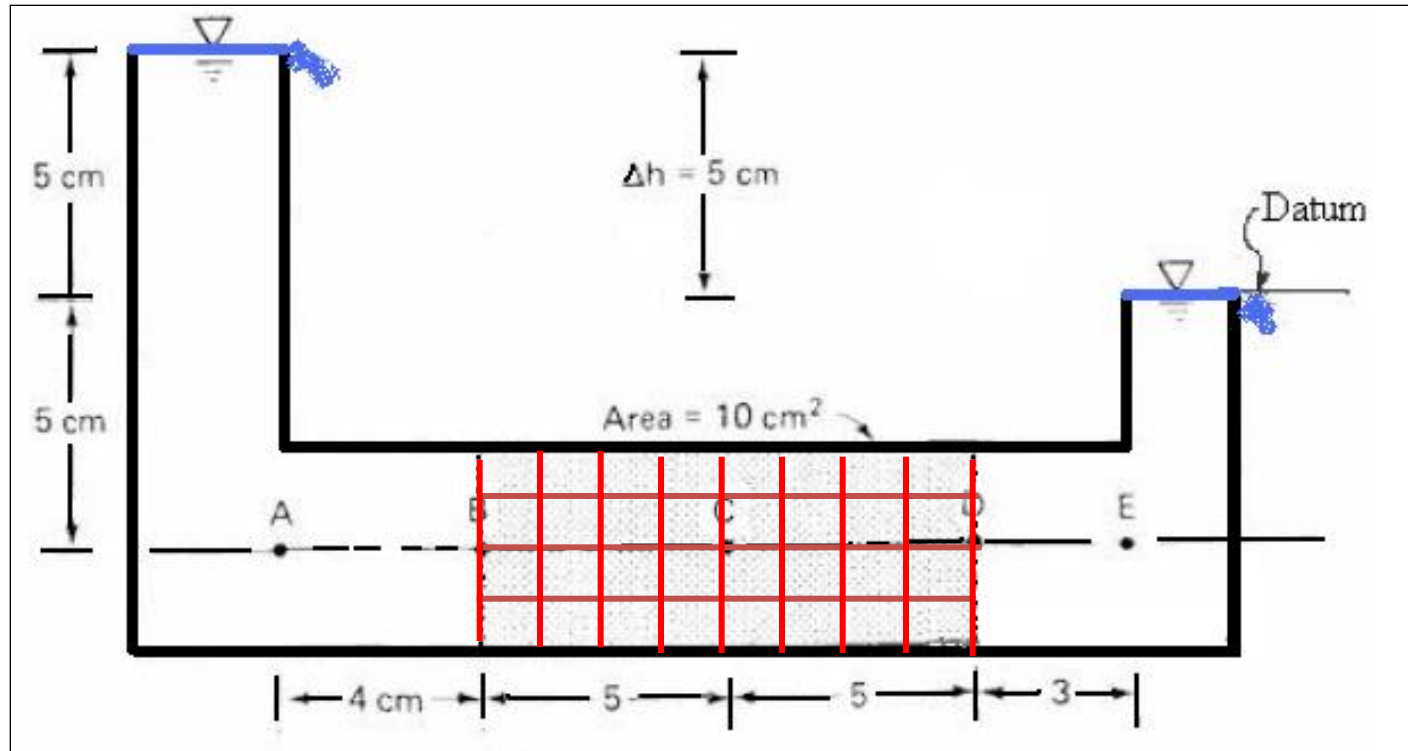

We can see also that there are TWO families of lines:

- Horizontal lines which represent the direction of flow of water particles.
- Vertical lines which represent lines of constant total head.

Theoretical Basis of Flow Nets

$$\frac{\partial^2 h}{\partial x^2} + \frac{\partial^2 h}{\partial z^2} = 0$$

- ⊙ The governing equation is a **2nd order homogeneous, partial** differential equation with **constant** coefficients.
- ⊙ The solution of this equation is represented by **two functions** which both satisfies the equation and any relevant boundary conditions.
- ⊙ These functions are the **potential function $\Phi(x,z)$** and the **flow function $\psi(x,z)$** . These functions represent a **family** of equipotential lines and a **family** of flow lines constituting what is referred to as a **FLOW NET**.
- ⊙ These lines are proved to be **orthogonal**.
- ⊙ What we actually do, we by following specific rules find the **FLOW Net** by which we reach the solution of Laplace's equation.
- ⊙ In other word **flow net** is actually a graphical solution of Laplace's Equation in **2-D**.

FUNDAMENTAL DEFINITIONS

- A line along which a water particle will travel from upstream to the downstream side in the permeable soil medium is called a **FLOW LINE (OR STREAM LINE)**.
- A line along which the **TOTAL HEAD** at all points is the same is called **EQUIPOTENTIAL** line.
- If piezometers are placed at different points along an equipotential line, the water level will rise to the **same elevation** in all of them.

*Different pressure heads
but equal total heads*

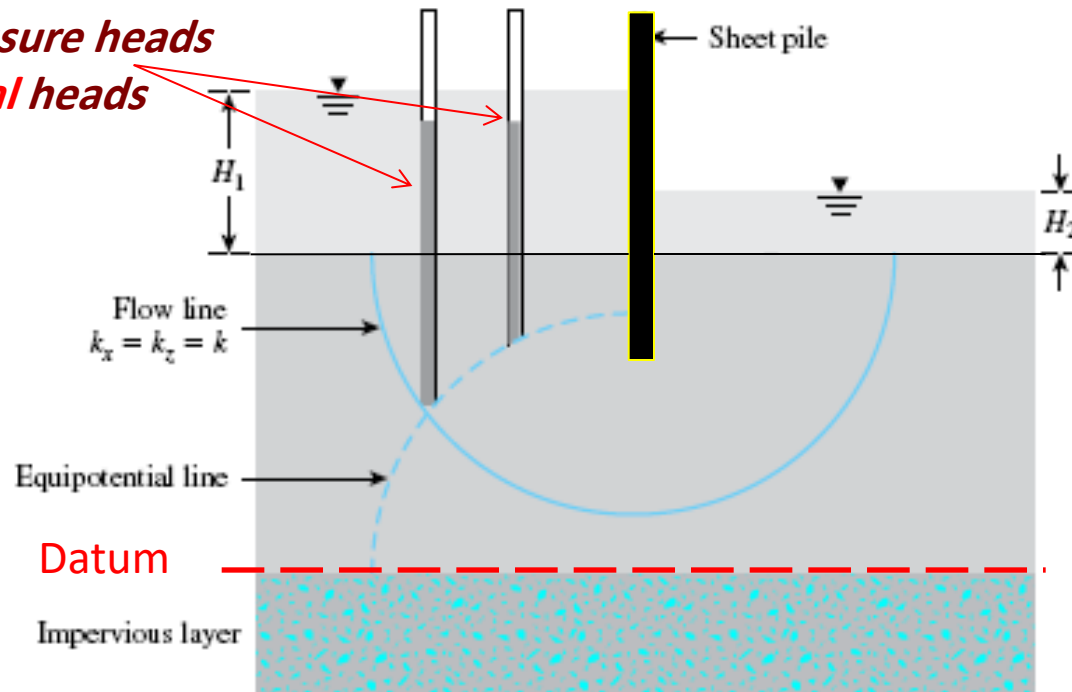

FUNDAMENTAL DEFINITIONS

- The space between any two adjacent flow lines is called **FLOW PATH, FLOW TUBE, or FLOW CHANNEL**.
- The space between any two equipotential lines is called **EQUIPOTENTIAL SPACE**.
- The mesh made by a number of flow lines and equipotential lines is called a **FLOW NET**.
- The “Phreatic surface” is the top flow line

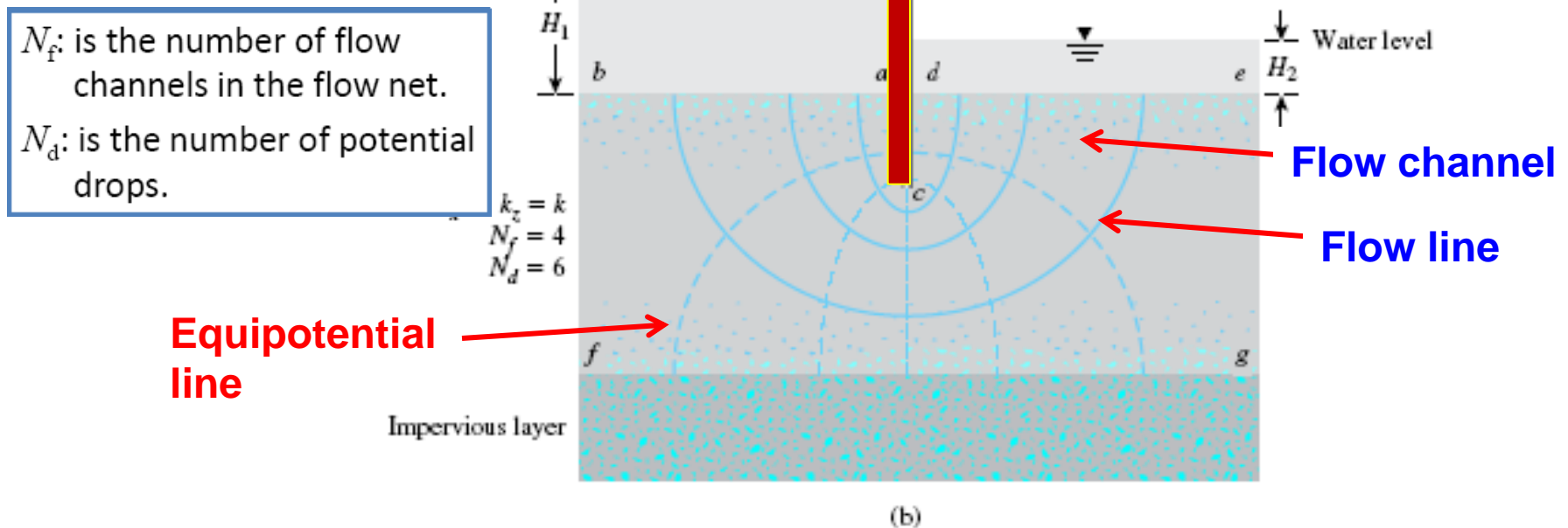

FLOW NETS

To complete the graphic construction of a flow net, one must draw the flow and equipotential lines in such a way that:

1. The equipotential lines intersect the flow lines at **right angles**.
2. The flow elements formed are approximate **squares**.

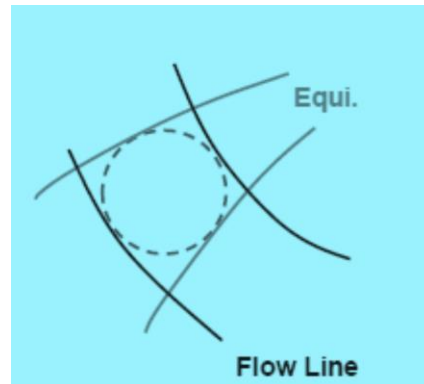

FLOW NETS

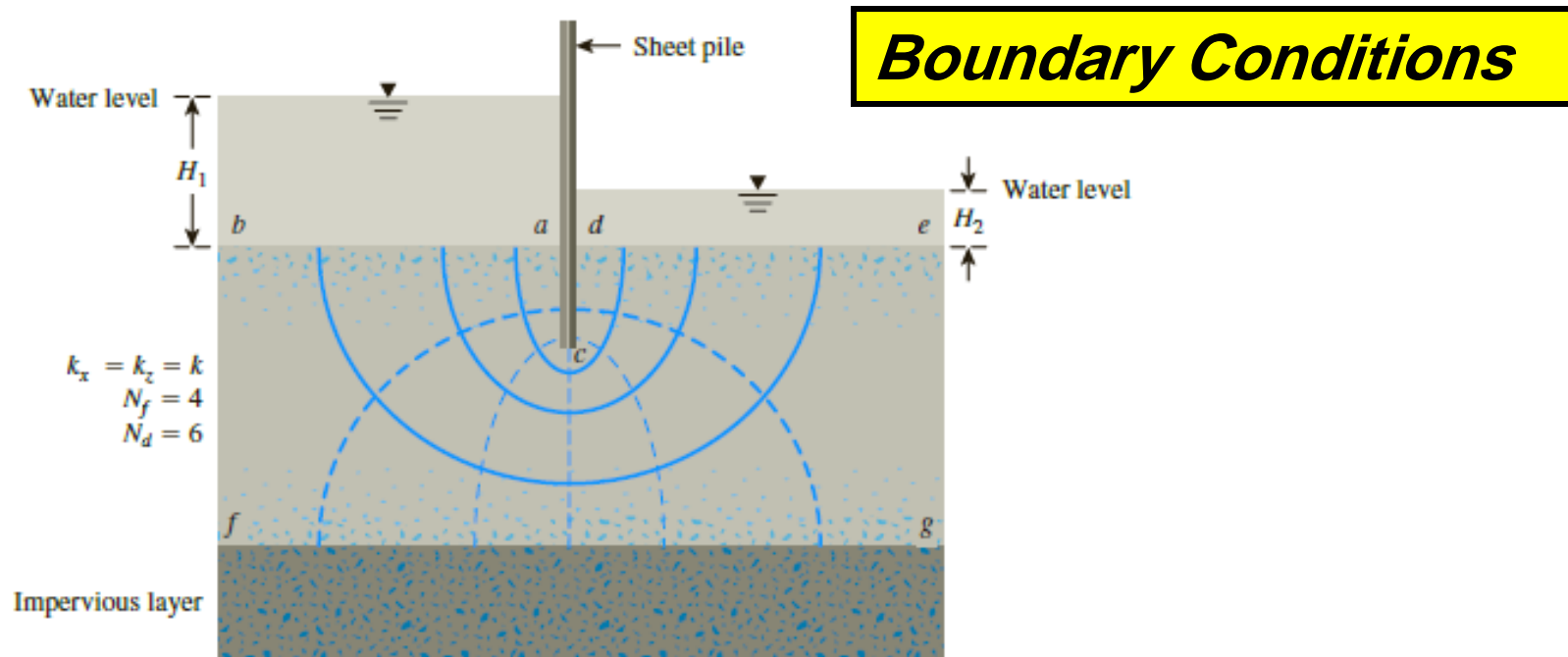

- Condition 1.** The upstream and downstream surfaces of the permeable layer (lines ab and de) are equipotential lines.
- Condition 2.** Because ab and de are equipotential lines, all the flow lines intersect them at right angles.
- Condition 3.** The boundary of the impervious layer—that is, line fg —is a flow line, and so is the surface of the impervious sheet pile, line acd .
- Condition 4.** The equipotential lines intersect acd and fg at right angles.

FLOW NETS

Boundary Conditions

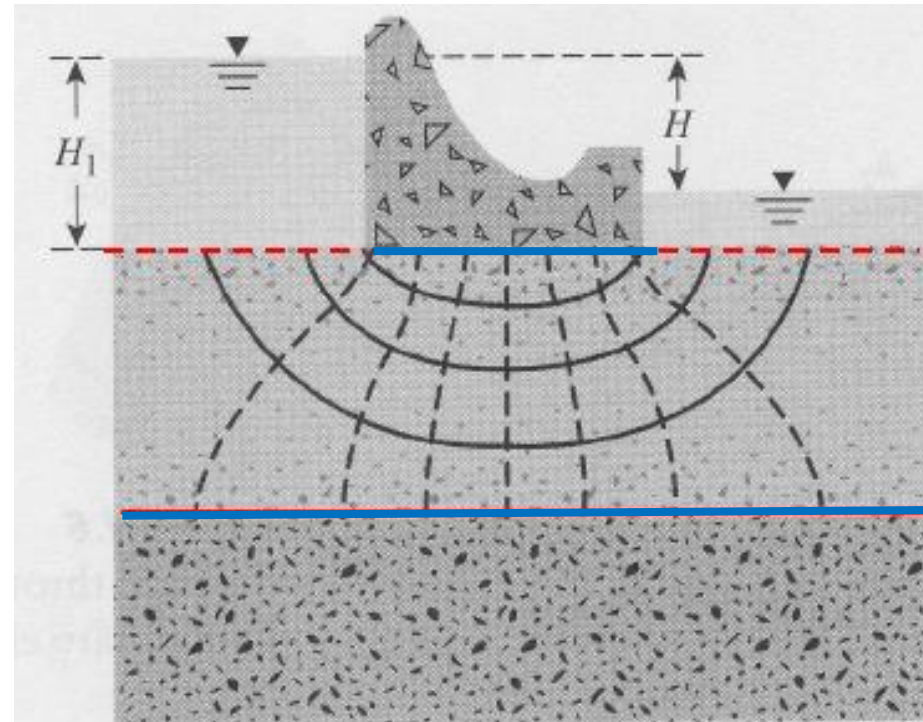
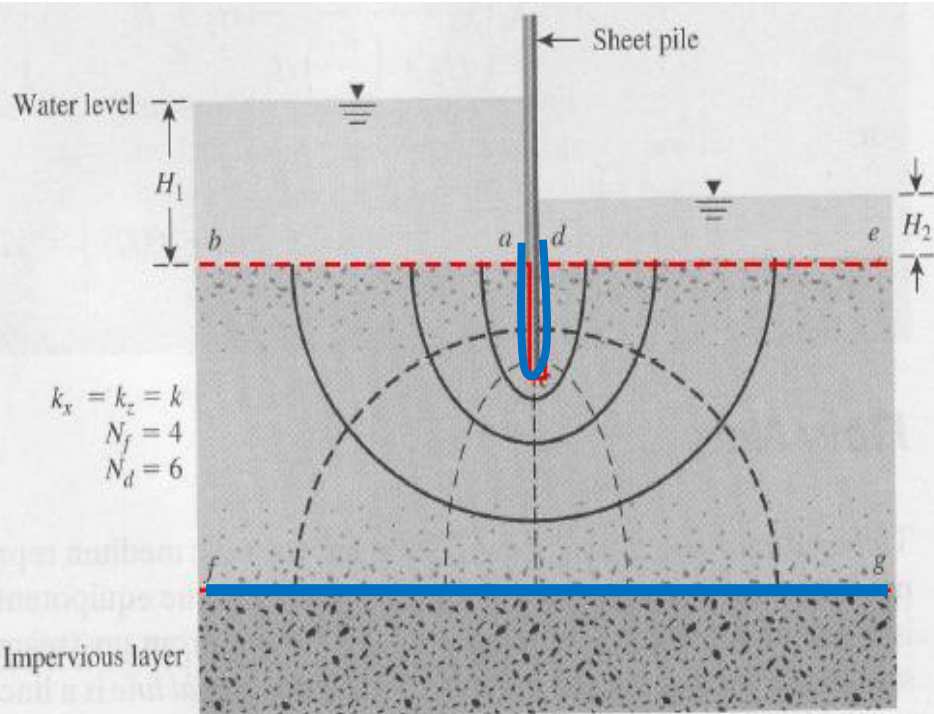

Blue : Flow line

Red : Equipotential line

Rules Followed in Sketching Flow Nets

1. Flow lines and equipotential lines must intersect at **right** angles.
2. Constant head boundaries represent **initial** or **final equipotential**.
3. Impermeable (no-flow) boundaries are flow lines.
4. Adjacent equipotentials have equal head loss ($= h/N_d$)
5. The same quantity of seepage flows between pairs of flow lines (i.e. **equal flow channels**).

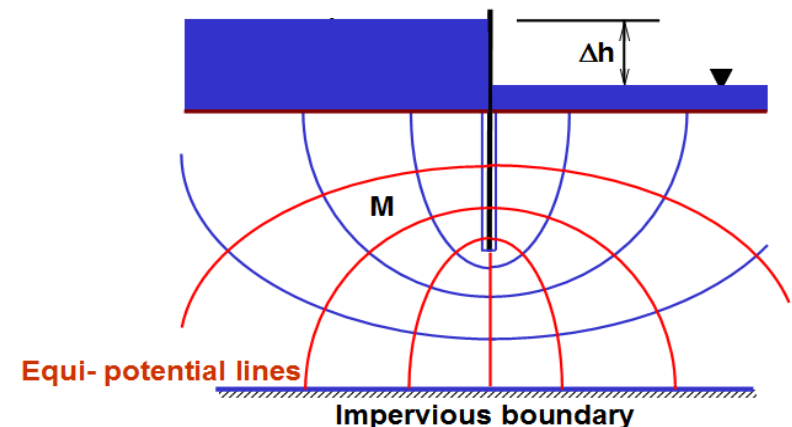

Rules Followed in Sketching Flow Nets

6. Geometric figures formed by pairs of flow lines and equipotential lines must be essentially **squares**. This is the case when we have a **true flow net**. In more practical case involving **curvilinear** flow, the figures cannot be true squares. However they must have right angles at the corners and the two median dimensions of each figure must be equal.

Note:

Drawing of square elements is convenient but not always necessary

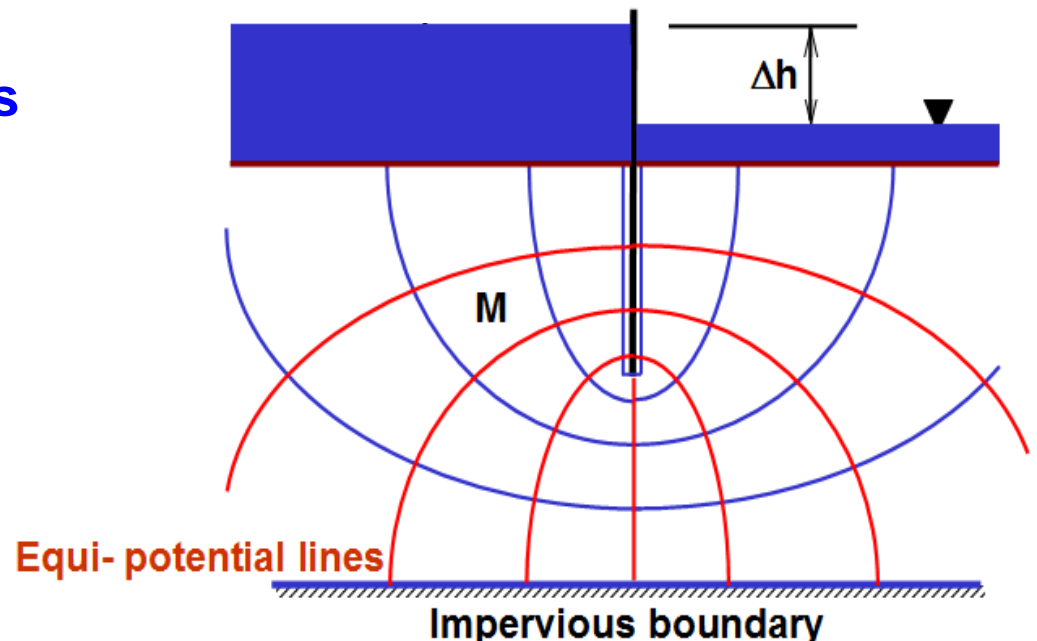

STEPS IN CONSTRUCTING FLOW NETS

- **Step 1:** Draw to a convenient scale a cross-section of the **medium** and its **boundaries**.
- **Step 2:** Establish the **two** boundary **flow lines** and the **two** boundary **equipotential lines**.
- **Step 3:** By trial and error sketch a network of flow lines and equipotential lines, observing the right-angle intersection and the space figures rules.

Where flow direction is a straight line, flow lines are an equal distance apart and parallel.

- **Step 4:** At first attempt certainly there will be some inconsistencies. Successive trials are made until the net is reasonably consistent throughout.

GENERAL SUGGESTIONS AND TIPS

- Be practical in selecting a scale for the drawing. A scale that is too large waste time and eraser.
- Before starting the sketch a flow net look for important boundary conditions.
- Use as few flow lines (and resulting equipotential lines) as possible. Generally **THREE to FIVE** lines will be sufficient.
- Always watch the appearance of the entire flow net. Do not make fine detail adjustments until the entire flow net is approximately correct.
- Try to keep the number of flow channels to a whole number.
- Remember, flow lines do not intersect the lower boundary since itself is a flow line.
- Obtaining results from a rough flow net is considered adequate. The error committed is relatively small in comparison to the accuracy we obtain for the **coefficient of permeability**.



SEEPAGE CALCULATION FROM FLOW NETS

SEEPAGE CALCULATION FROM FLOW NETS

Let us first consider the case of **straight** flow and equipotential lines (**i.e. perfect squares**) as shown in the figure below.

- In a flow net, the strip between any two adjacent flow lines is called a **flow channel**.
- The drop in the total head between any two adjacent equipotential lines is called the **potential drop**.

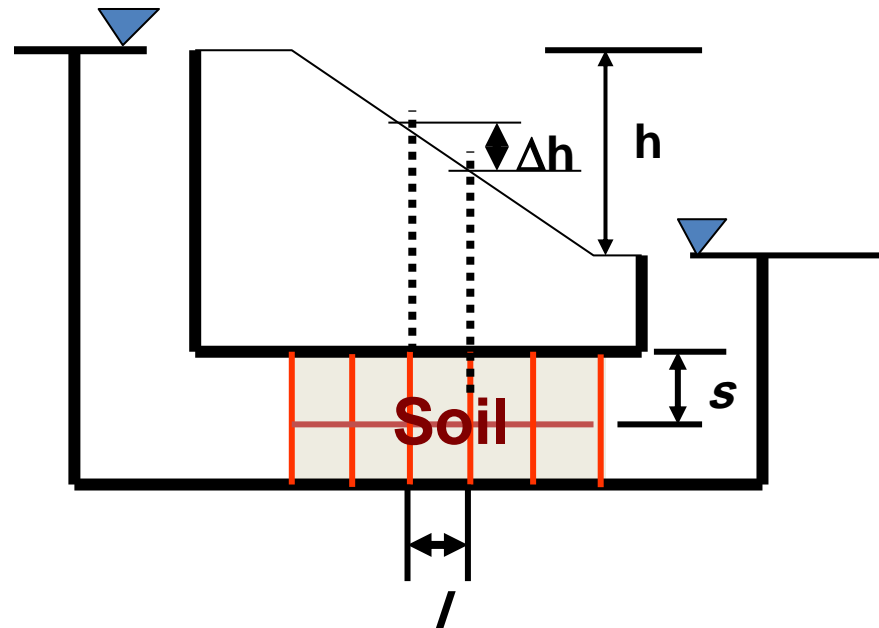

SEEPAGE CALCULATION FROM FLOW NETS

- ➡ Applying Darcy's law, the flow in each **flow channel** is

$$\Delta q = kiA \quad \left(\text{But } i = \frac{\Delta h}{l}, \quad A = s \cdot 1 = s \right) \longrightarrow \boxed{\Delta q = k \frac{\Delta h}{l} s}$$

- ➡ Since the figures are squares (as must be the case in general) ***s*** = 1, and hence $\Delta q = k\Delta h$

- ➡ Since the potential drop between any two adjacent equipotential lines is the same, then
$$\Delta h = \frac{h}{N_d}$$

Where **N_d** is the number of potential drops.

$$\Delta q = k \frac{h}{N_d}$$

- ➡ If the number of flow channels is **N_f** , then the total discharge q per unit depth (perpendicular to the paper) is

$$q = N_f \Delta q \longrightarrow$$

$$\boxed{q = kh \frac{N_f}{N_d} \dots\dots (*)}$$

SEEPAGE CALCULATION FROM FLOW NETS

- Equation (*) is the basic equation for computation of seepage quantities from flow net.
- The ratio N_f/N_d is called the **shape factor**.
- Equation (*) for the case when the width of the cross-section of the channel normal to the page is **UNITY**.
- If it is not we have to multiply it by the given value of the width, or

$$q = kh \frac{N_f}{N_d} b$$

Eq. (**)

SEEPAGE CALCULATION FROM FLOW NETS

CURVILINEAR FLOW AND EQUIPOTENTIAL LINES

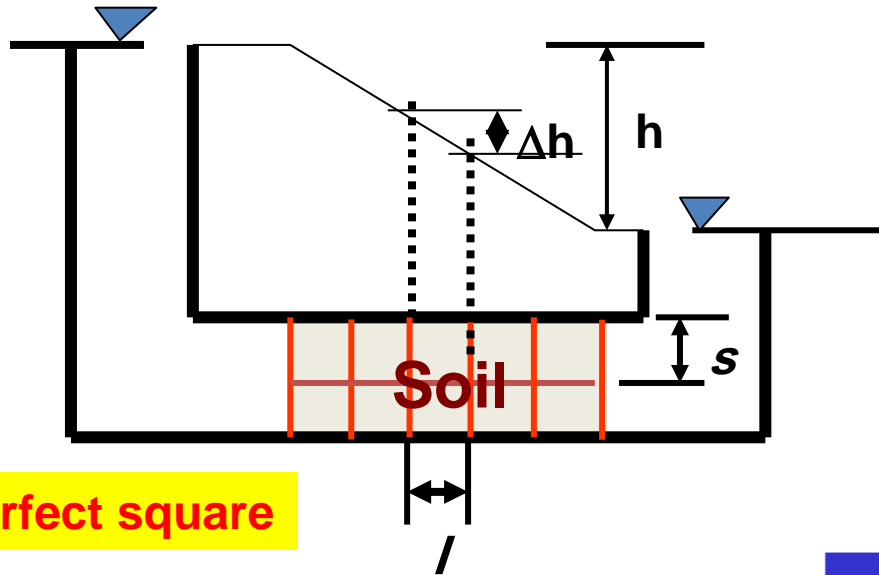

Perfect square

$$q = kh \frac{N_f}{N_d} \dots\dots (*)$$

$$q = k h \left(\frac{N_f}{N_d} \right)$$

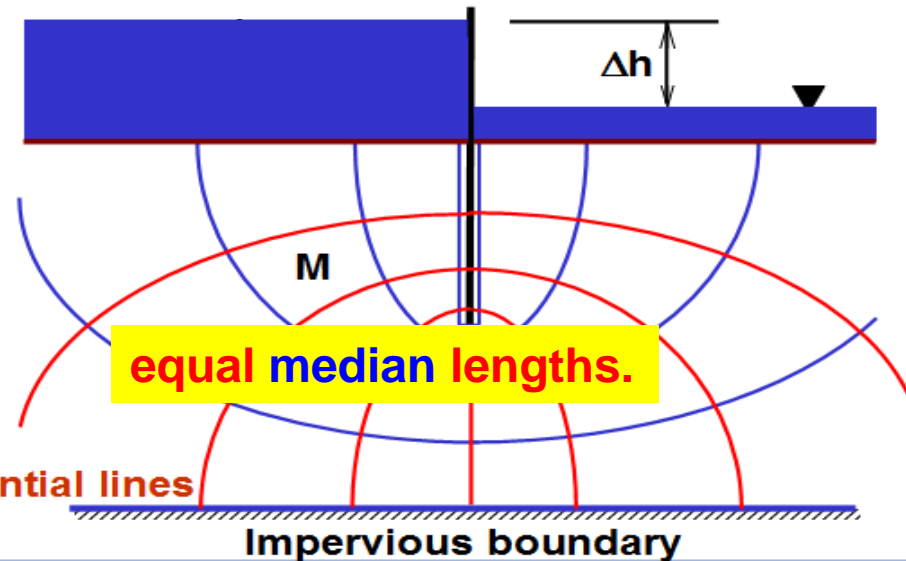
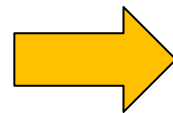

Equi-potential lines

SEEPAGE CALCULATION FROM FLOW NETS

CURVILINEAR FLOW AND EQUIPOTENTIAL LINES

Case I: Square Elements (medians are equal)

1. Because there is no flow across the **flow line**, rate of flow through the flow channel per unit width perpendicular to the flow direction is the same, or

$$\Delta q_1 = \Delta q_2 = \Delta q_3 = \Delta q$$

2. The potential drop is the same and equal to:

$$h_1 - h_2 = h_2 - h_3 = h_3 - h_4 = \frac{h}{N_d}$$

Where **h** : head difference between the upstream and downstream sides.
 N_d : number of potential drops.

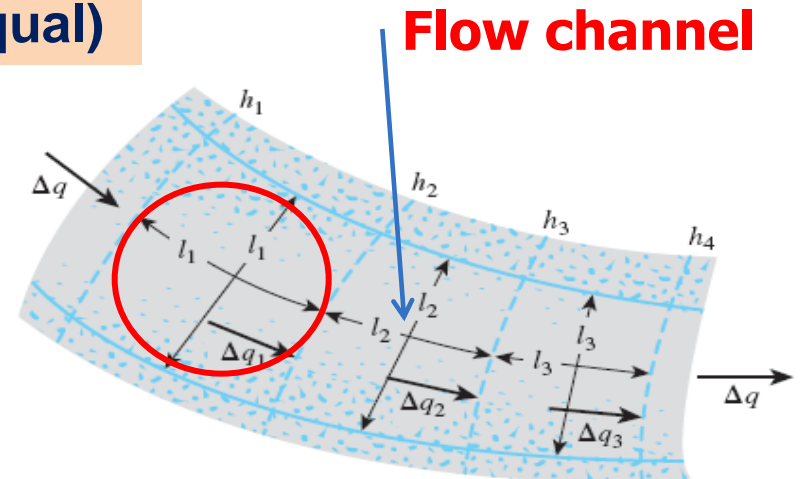

SEEPAGE CALCULATION FROM FLOW NETS

From Darcy's Law, the rate of flow is equal to:

$$\Delta q = k \left(\frac{h_1 - h_2}{l_1} \right) l_1 = k \left(\frac{h_2 - h_3}{l_2} \right) l_2 = k \left(\frac{h_3 - h_4}{l_3} \right) l_3 = \dots$$

$$h_1 - h_2 = h_2 - h_3 = h_3 - h_4 = \dots = \frac{H}{N_d}$$

$$\Delta q = k \frac{H}{N_d}$$

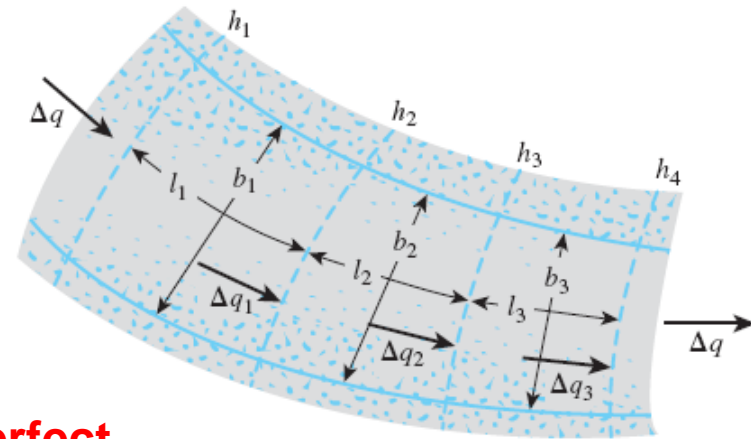

Note: Here we took the median lengths, for perfect square we have side lengths

If the number of flow channels in a flow net is equal to N_f , the total rate of flow through all the channels per unit length can be given by:

$$q = k h \left(\frac{N_f}{N_d} \right)$$

Eq. (***)same as Eq. (*)

Instead of thinking of perfect square, we always consider the most general curvilinear case and assuming equal median lengths.

SEEPAGE CALCULATION FROM FLOW NETS

Case II: Rectangular Elements

- Drawing of square elements is convenient but not **always necessary**
- Alternatively, one can draw a rectangular mesh for a flow channel provided that the **width-to-length** ratios for **all** the rectangular elements in the flow net are the same

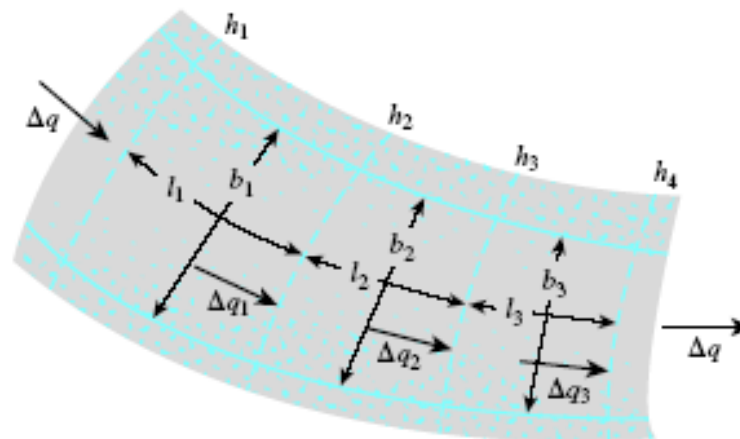

SEEPAGE CALCULATION FROM FLOW NETS

Case II: Rectangular Elements

- In this case the rate of flow through the channel is expressed as

$$\Delta q = k \left(\frac{h_1 - h_2}{l_1} \right) b_1 = k \left(\frac{h_2 - h_3}{l_2} \right) b_2 = k \left(\frac{h_3 - h_4}{l_3} \right) b_3 = \dots$$

If $b_1/l_1 = b_2/l_2 = b_3/l_3 = \dots = n$ (i.e., the elements are not square),

$$\Delta q = kH \left(\frac{n}{N_d} \right)$$

If the number of flow channels in a flow net is equal to N_f , the total rate of flow through all the channels per unit length can be given by

$$q = k h \left(\frac{N_f}{N_d} \right) n$$

SEEPAGE CALCULATION FROM FLOW NETS

Three Cases:

1. Square

If not

2. Curvilinear square where Medians are equal

If not

3. Curvilinear rectangular with width-to-length ratio being the same

SEEPAGE CALCULATION FROM FLOW NETS

SUMMARY

- Case of **unit depth** (perpendicular to the paper)
- Case when the width of the cross-section of the channel normal to the page is not **UNITY**.

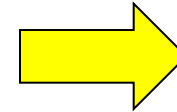

$$q = k h \left(\frac{N_f}{N_d} \right)$$

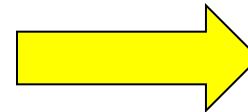

$$q = k h \frac{N_f}{N_d} b$$

- Case of **Square Elements** (medians are equal)

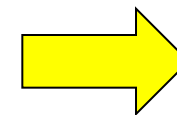
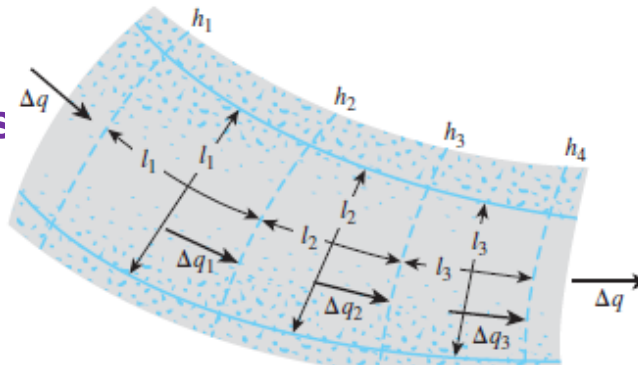

$$q = k h \left(\frac{N_f}{N_d} \right)$$

- Case of **Rectangular Elements** (medians are **not** equal)

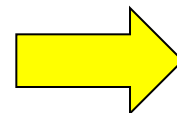
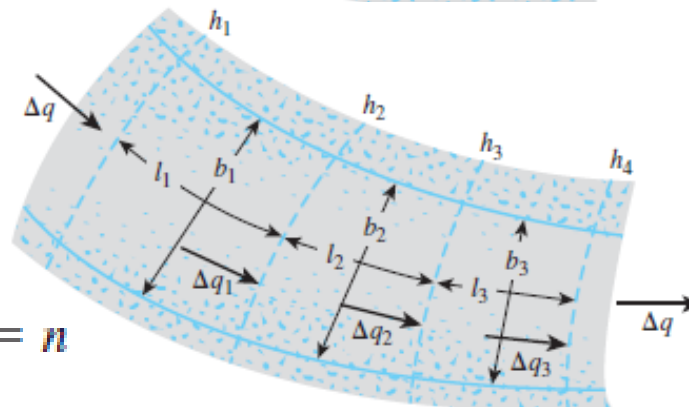

$$q = k h \left(\frac{N_f}{N_d} \right) n$$

$$b_1/l_1 = b_2/l_2 = b_3/l_3 = \dots = n$$

SEEPAGE CALCULATION FROM FLOW NETS

- The general case:
 - The cross-section of the channel normal to the page is not UNITY
 - Medians are not equal

$$q = k h \left(\frac{N_f}{N_d} \right) n \cdot b$$

EXAMPLE

If the horizontal cylinder of soil shown below has a coefficient of permeability of 0.01 cm/sec. Calculate the amount of flow through the soil.

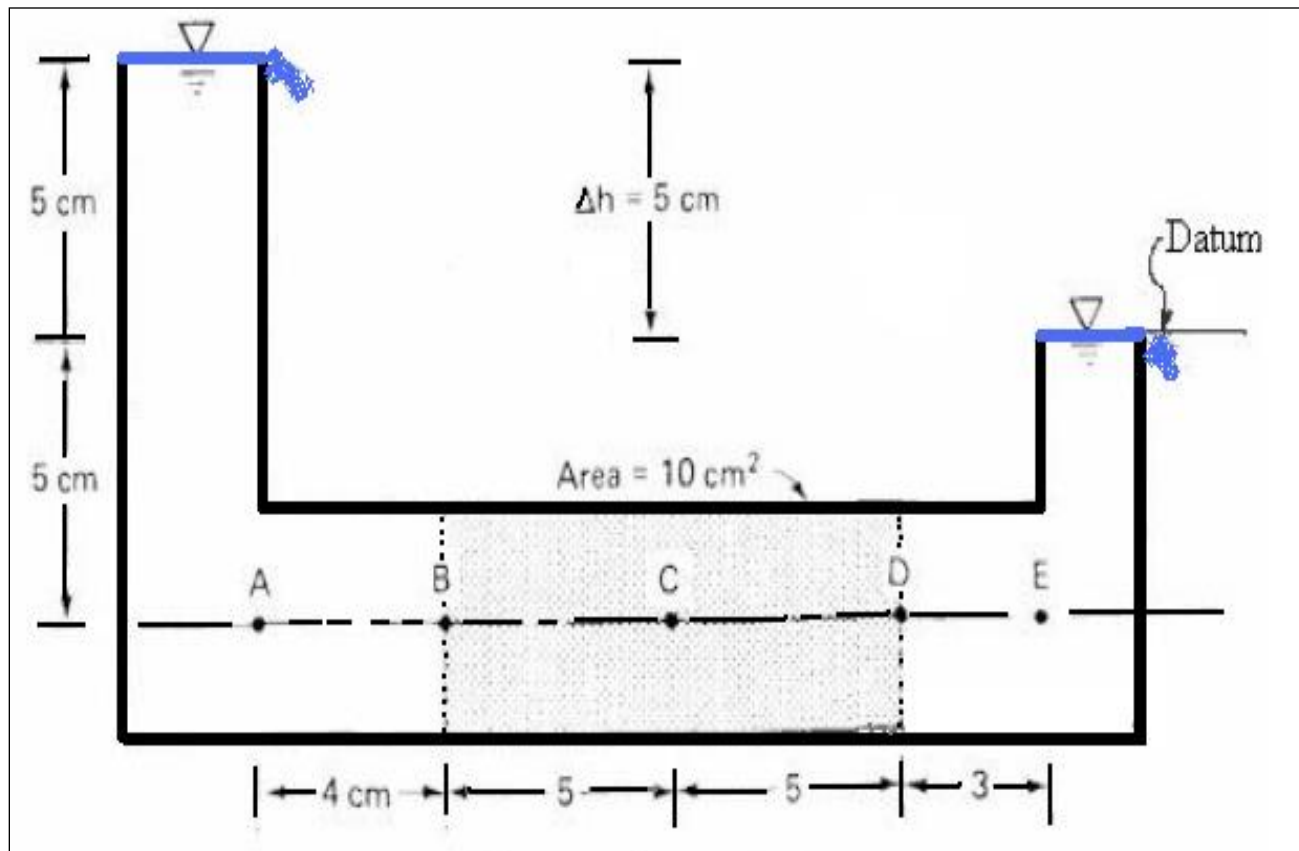

EXAMPLE

Considering it as a 1-D problem

we can apply Darcy's law directly

$$q = vA = kiA = 0.01 \times (5/10) \times 10 = 0.05 \text{ cm}^3/\text{s}$$

Considering it as a 2-D problem

$$q = kh \frac{N_f}{N_d} b$$

$$q = 0.01 \times 5 \times 4/8 \times 2 = 0.05 \text{ cm}^3/\text{s}$$

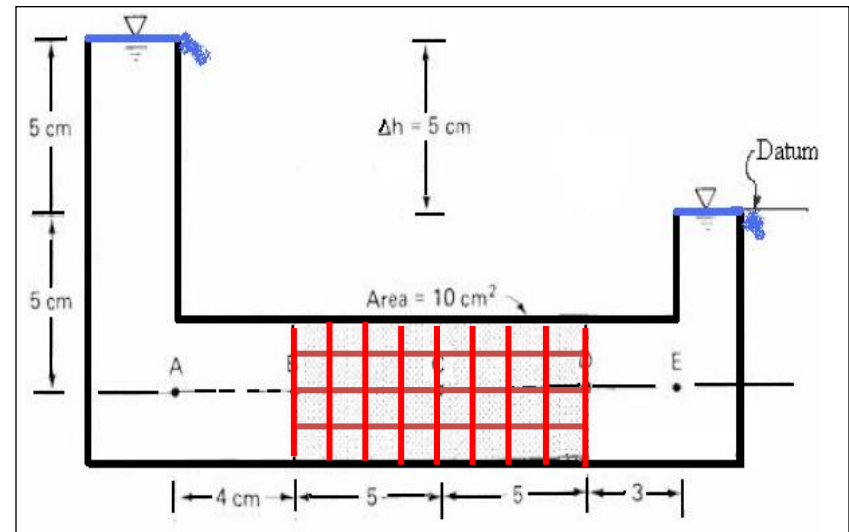

According to rule of square mesh the height of the soil must equal 5 cm and hence in the 3rd direction **2 cm**.

EXAMPLE 8.1

Example 8.1

A flow net for flow around a single row of sheet piles in a permeable soil layer is shown in Figure 8.6. Given that $k_x = k_z = k = 5 \times 10^{-3}$ cm/sec, determine

- How high (above the ground surface) the water will rise if piezometers are placed at points *a* and *b*
- The total rate of seepage through the permeable layer per unit length
- The approximate average hydraulic gradient at *c*

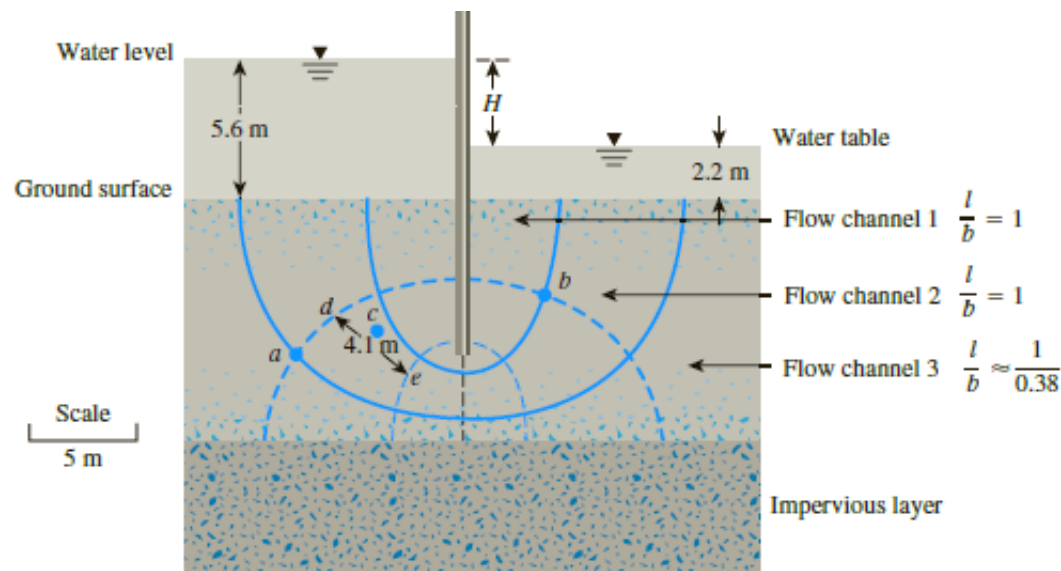

EXAMPLE 8.1

Solution

Part a

From Figure 8.6, we have $N_d = 6$, $H_1 = 5.6$ m, and $H_2 = 2.2$ m. So the head loss of each potential drop is

$$\Delta H = \frac{H_1 - H_2}{N_d} = \frac{5.6 - 2.2}{6} = 0.567 \text{ m}$$

At point a , we have gone through one potential drop. So the water in the piezometer will rise to an elevation of

$$(5.6 - 0.567) = \mathbf{5.033 \text{ m above the ground surface}}$$

At point b , we have five potential drops. So the water in the piezometer will rise to an elevation of

$$[5.6 - (5)(0.567)] = \mathbf{2.765 \text{ m above the ground surface}}$$

Part b

From Eq. (8.14),

$$\begin{aligned} q &= 2.38 \frac{k(H_1 - H_2)}{N_d} = \frac{(2.38)(5 \times 10^{-5} \text{ m/sec})(5.6 - 2.2)}{6} \\ &= \mathbf{6.74 \times 10^{-5} \text{ m}^3/\text{sec/m}} \end{aligned}$$

Part c

The average hydraulic gradient at c can be given as

$$i = \frac{\text{head loss}}{\text{average length of flow between } d \text{ and } e} = \frac{\Delta H}{\Delta L} = \frac{0.567 \text{ m}}{4.1 \text{ m}} = \mathbf{0.138}$$

(Note: The average length of flow has been scaled.)

EXAMPLE 8.2

Example 8.2

Seepage takes place around a retaining wall shown in Figure 8.7. The hydraulic conductivity of the sand is 1.5×10^{-3} cm/s. The retaining wall is 50 m long. Determine the quantity of seepage across the entire wall per day.

Solution

For the flow net shown in Figure 8.7, $N_f = 3$ and $N_d = 10$. The total head loss from right to left, $H = 5.0$ m. The flow rate is given by [Eq. (8.10)],

$$q = kH \frac{N_f}{N_d} = (1.5 \times 10^{-5} \text{ m/s})(5.0) \left(\frac{3}{10} \right) = 2.25 \times 10^{-5} \text{ m}^3/\text{s}/\text{m}$$

Seepage across the entire wall,

$$Q = 2.25 \times 10^{-5} \times 50.0 \times 24 \times 3600 \text{ m}^3/\text{day} = 97.2 \text{ m}^3/\text{day}$$

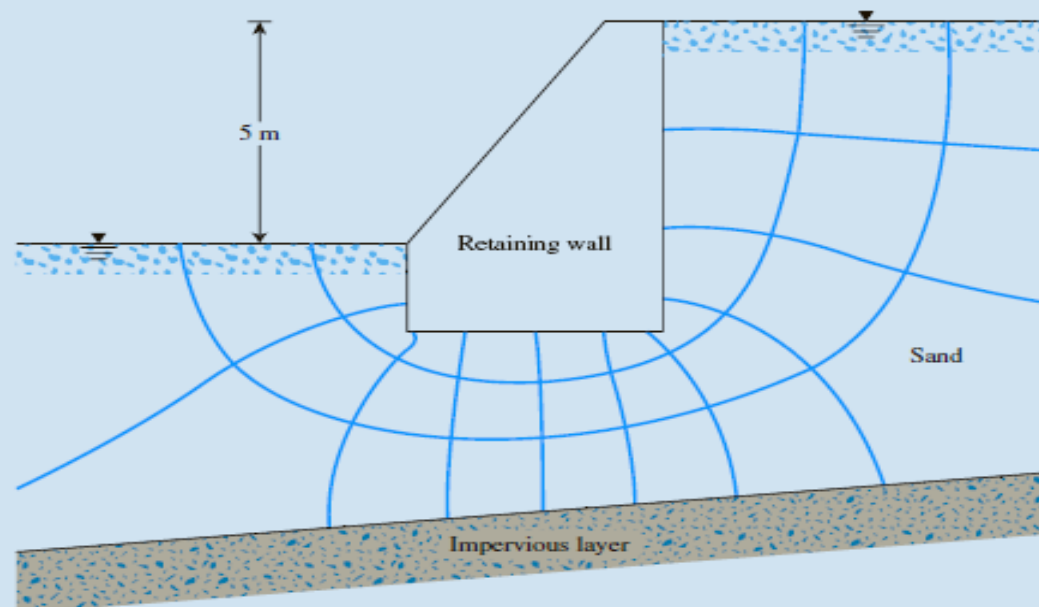

EXAMPLE

If $k = 10^{-7}$ m/sec, what would be the flow per day over a 100 m length of wall?

Solution

$$q = kh \frac{N_f}{N_d} b$$

$$N_f = 5$$

$$N_d = 14$$

$$h = 45 \text{ m}$$

$$k = 10^{-7} \text{ m/sec}$$

$$\begin{aligned} q &= 10^{-7} \times 45 \times (5/14) \times 100 \\ &= 0.000161 \text{ m}^3/\text{sec} \\ &= \mathbf{13.9 \text{ m}^3/\text{day}} \end{aligned}$$

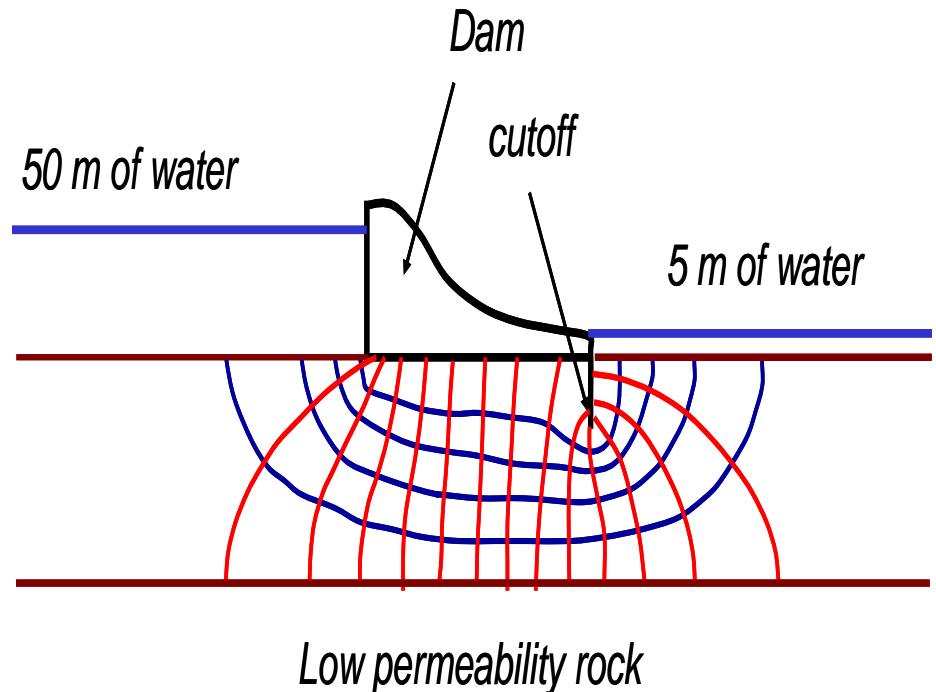

FLOW NETS

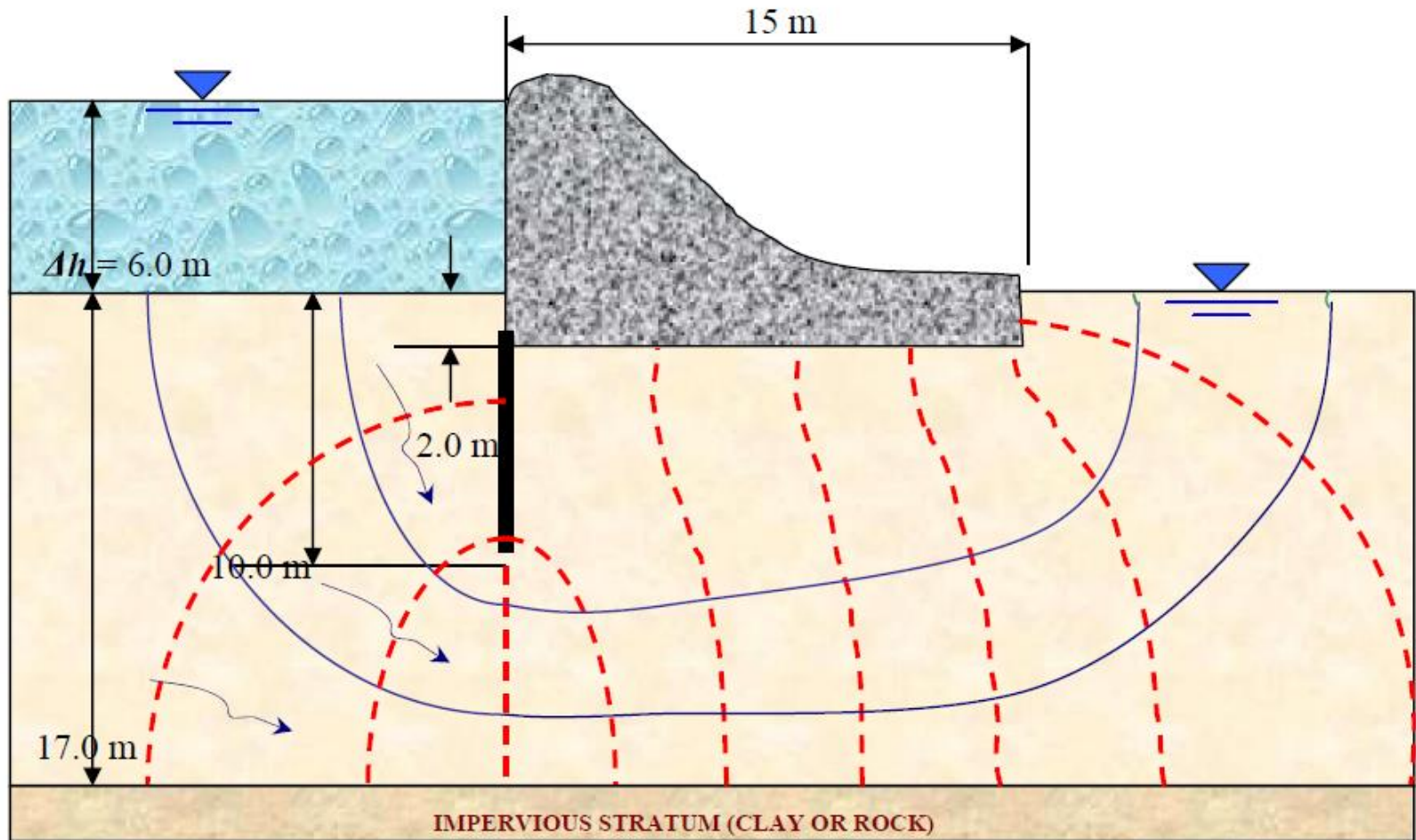

Calculation of Heads

Consider Point X

Total head = h - # of drops from upstream $\times \Delta h$

Elevation head = $-z$

Pressure head = Total head - Elevation head

$$h = \frac{u}{\gamma_w} + Z$$

$$= \frac{h}{N_d}$$

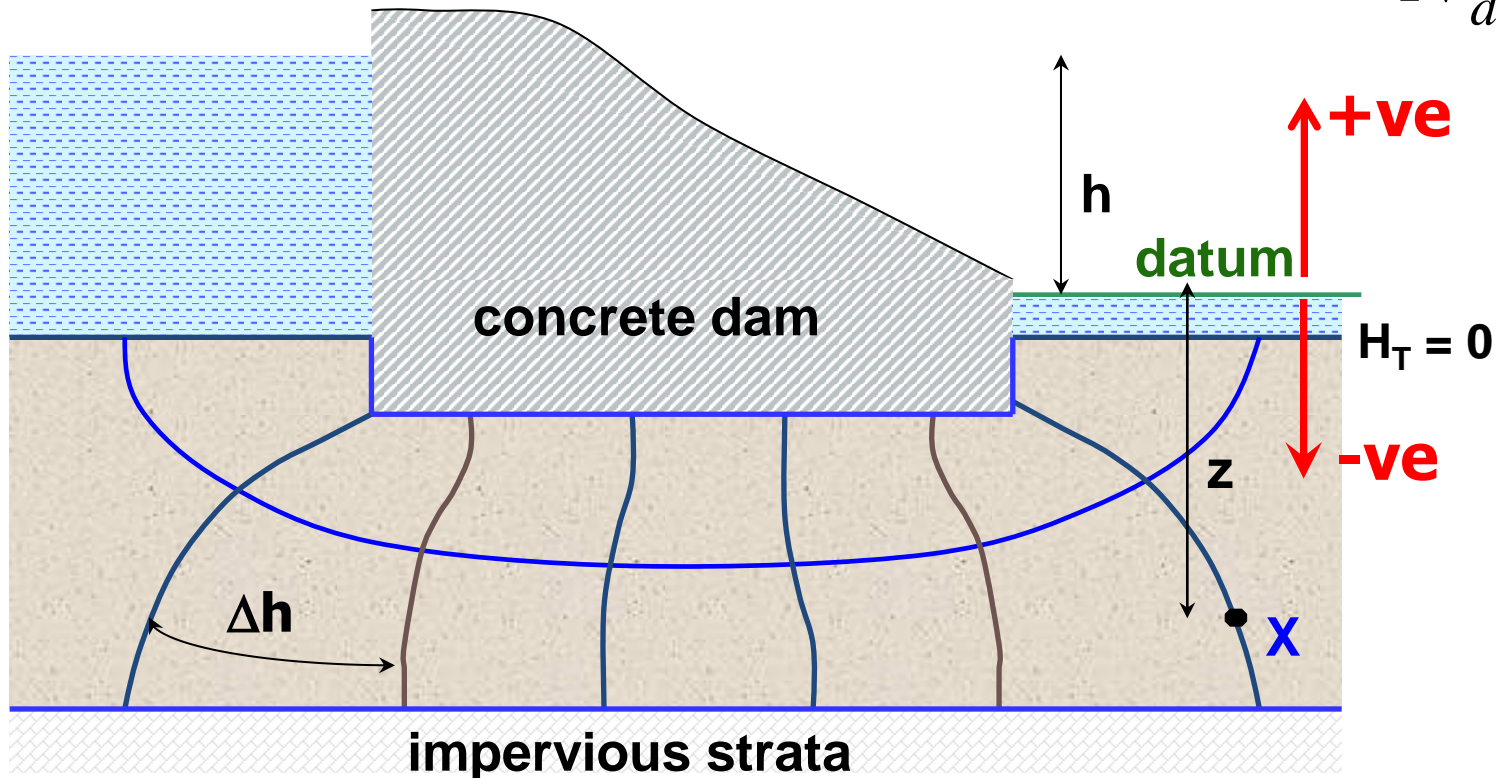

EXAMPLE

Uplift pressure under hydraulic structures

$$H = 7\text{ m} \quad N_d = 7$$

Head Loss at each equipotential line
 $= 7/7 = 1\text{ m}$

$$h_{(a)} = 6\text{ m}, \quad h_{(b)} = 5\text{ m}, \quad \dots \quad h_{(f)} = 1\text{ m}$$

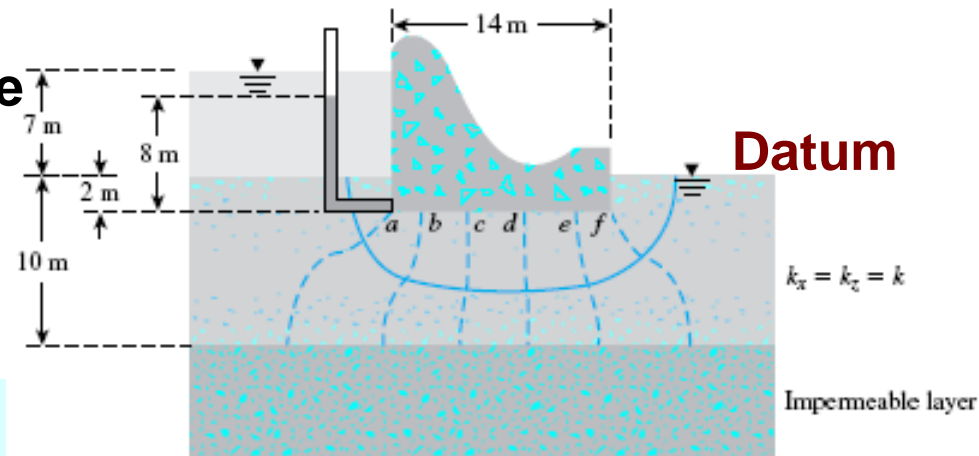

Recall

$$h = \frac{u}{\gamma_w} + Z$$

$$u = \gamma_w (h - Z)$$

$$u_{(a)} = \gamma_w (6 - (-2)) = 8\gamma_w$$

$$u_{(b)} = \gamma_w (5 - (-2)) = 7\gamma_w$$

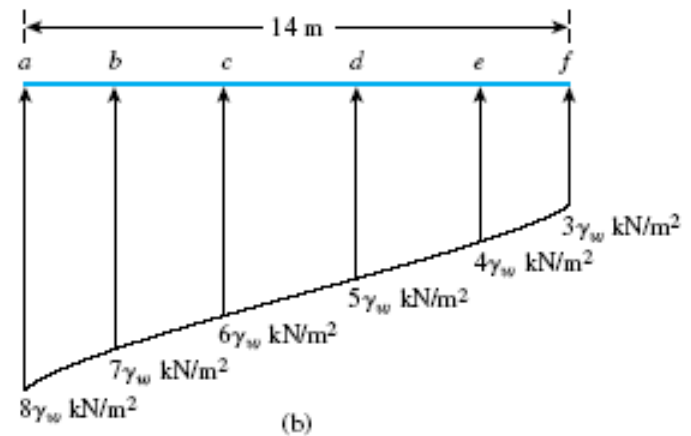

Figure 8.12 (a) A weir; (b) uplift force under a hydraulic structure

EXAMPLE

Consider the datum at the bottom border of the drainage layer

$H = 7\text{ m}$ $N_d = 7$
 Head Loss at each
 equipotential line = $7/7 = 1\text{ m}$

$$h = \frac{u}{\gamma_w} + Z$$

$$u = \gamma_w (h - Z)$$

$$u_{(a)} = \gamma_w (16 - 8) = 8\gamma_w$$

$$u_{(b)} = \gamma_w (15 - 8) = 7\gamma_w$$

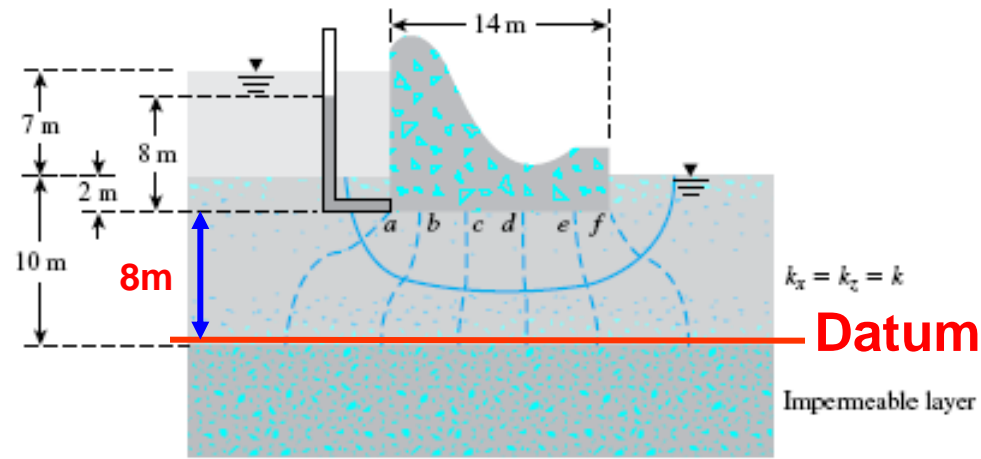

(a)

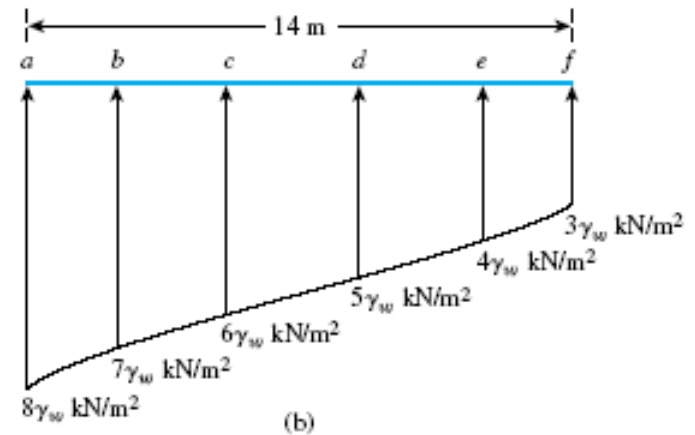

(b)

Figure 8.12 (a) A weir; (b) uplift force under a hydraulic structure

EXAMPLE

A stiff clay layer underlies a **12 m** thick silty sand deposit. A sheet pile is driven into the sand to a depth of 7 m, and the upstream and downstream water levels are as shown in the figure below.

$$k = 8.6 \times 10^{-6} \text{ m/sec}$$

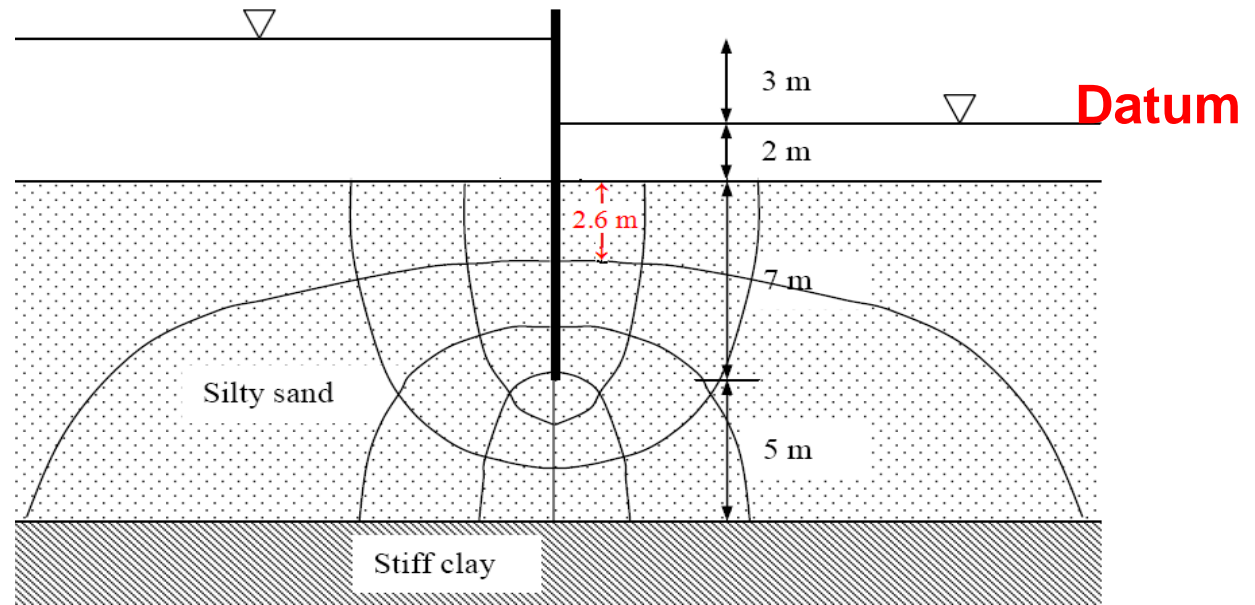

Estimate

- The seepage beneath the sheet pile in m^3/day per **meter**.
- What is the pore water pressure at the **tip** of the sheet pile?

EXAMPLE

Solution

- (a) In the flow net, $N_f = 3$; $N_d = 8$; $\Delta h = 3$ m. The flow (Q) is given by:

$$q = kh_L \frac{N_f}{N_d} = (8.6 \times 10^{-6})(3) \left(\frac{3}{8} \right) (24 \times 3600) = \underline{0.836 \text{ m}^3 / \text{day}} \text{ per metre}$$

- (b) Taking downstream water level as the datum, at the tip of the sheet pile,

Total head = 1.5 m

Elevation head = -9 m

\therefore Pressure head = $1.5 - (-9) = 10.5$ m

Pore water pressure = $(10.5)(9.81) = \underline{103.0 \text{ kPa}}$

$$h_{tip} = \frac{u_{tip}}{\gamma_w} + z_{tip}$$

$$q = kh \frac{N_f}{N_d} b$$

EXAMPLE

Let us try and take the datum at the bottom of the layer

Total head at the tip = $17 - 4 \times \frac{3}{8} = 15.5$ m

Elevation head = 5 m

$$h_{tip} = \frac{u_{tip}}{\gamma_w} + z_{tip}$$

$$15.5 = \frac{u_{tip}}{9.81} + 5$$

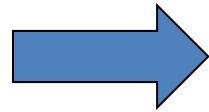

$$u_{tip} = (15.5 - 5) \times 9.81 = \underline{103.0 \text{ kPa}}$$

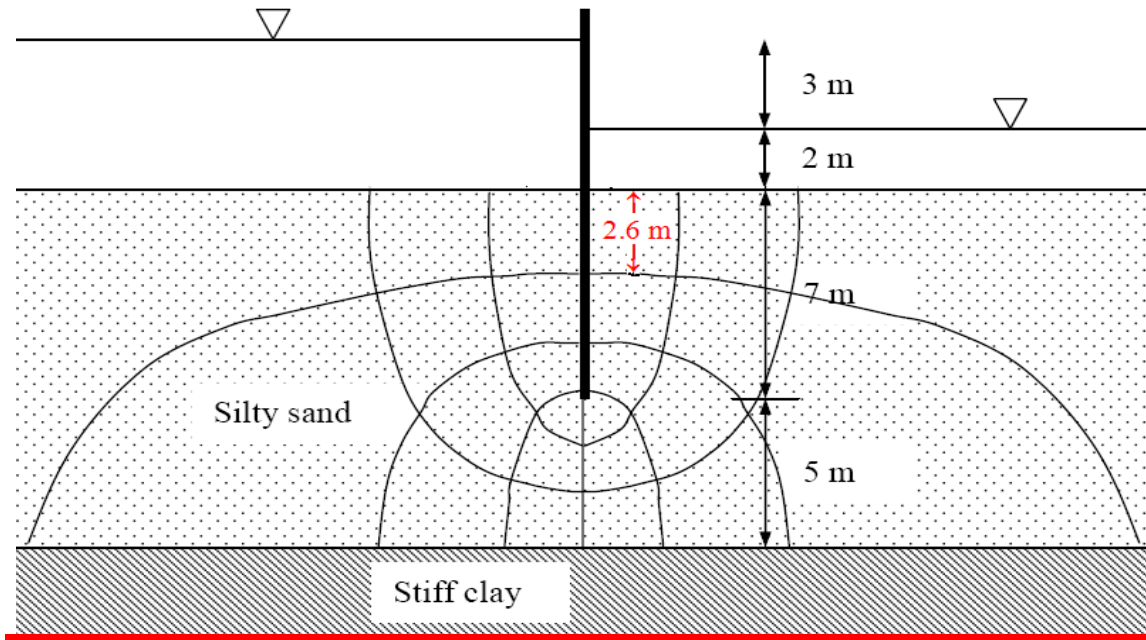

DATUM

EXAMPLE (2nd Midterm Exam Fall 40-41)

Question#3 (35%) [CLO 1= 30%, CLO 3 = 30%, CLO 4 = 40%]

For the concrete dam shown in Figure 3.

- I. Compute the flow under the dam per meter of the dam per day.
- II. To what level water should be allowed to rise above the downstream ground surface so that the existing rate of seepage is reduced by 25%?
- III. The pore water pressure at points (a) and (b).
- IV. Take the datum along the bottom flow line (line ①----②) and compute the pore water pressure at points (c) and (d).

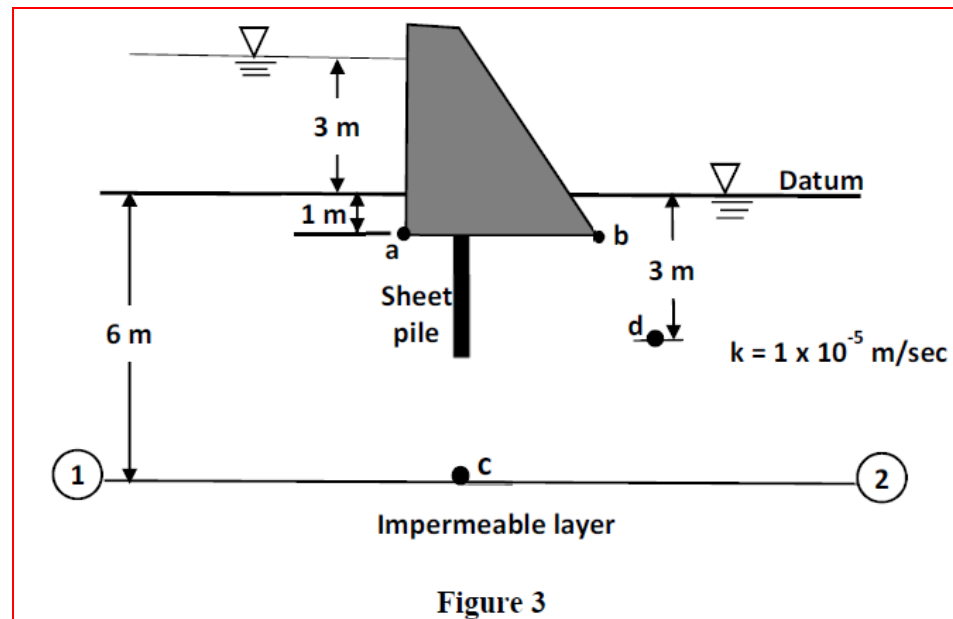

Figure 3

Common Mistake

$$h_a = \frac{u_a}{\gamma_w} + z_a$$

$$u_a = \gamma_w(h_a - z_a)$$

$$h_a = (h - n \times \Delta h)$$

$$u_a = \gamma_w(h - n \times \Delta h - z_a)$$

$$\Delta h = \frac{h}{n_d}$$

This is valid only if the DATUM is taken at the downstream water level.

$$u_a = \gamma_w\left(h - n \times \frac{h}{n_d} - z_a\right)$$

FLOW NETS

All times correct Steps

$$\Delta h = \frac{h}{n_d}$$

h = the head difference

$$h_a = (h - n \times \Delta h)$$

h = the distance from datum to the upstream water level.

$$h_a = \frac{u_a}{\gamma_w} + z_a$$

h and **h** are the same if and only if the **datum** is taken at downstream water level.

EXAMPLE (Final Exam Fall 38-39)

A river bed consists of a layer of **sand 8.25 m** thick overlying impermeable rock; the depth of water is **2.5 m**. A long cofferdam **5.50 m** wide is formed by driving two lines of sheet piling to a depth of **6.0 m** below the level of the river bed and excavation to a depth of **2.0 m** below bed level is carried out within the cofferdam. The section through a dam is shown in Figure 1.

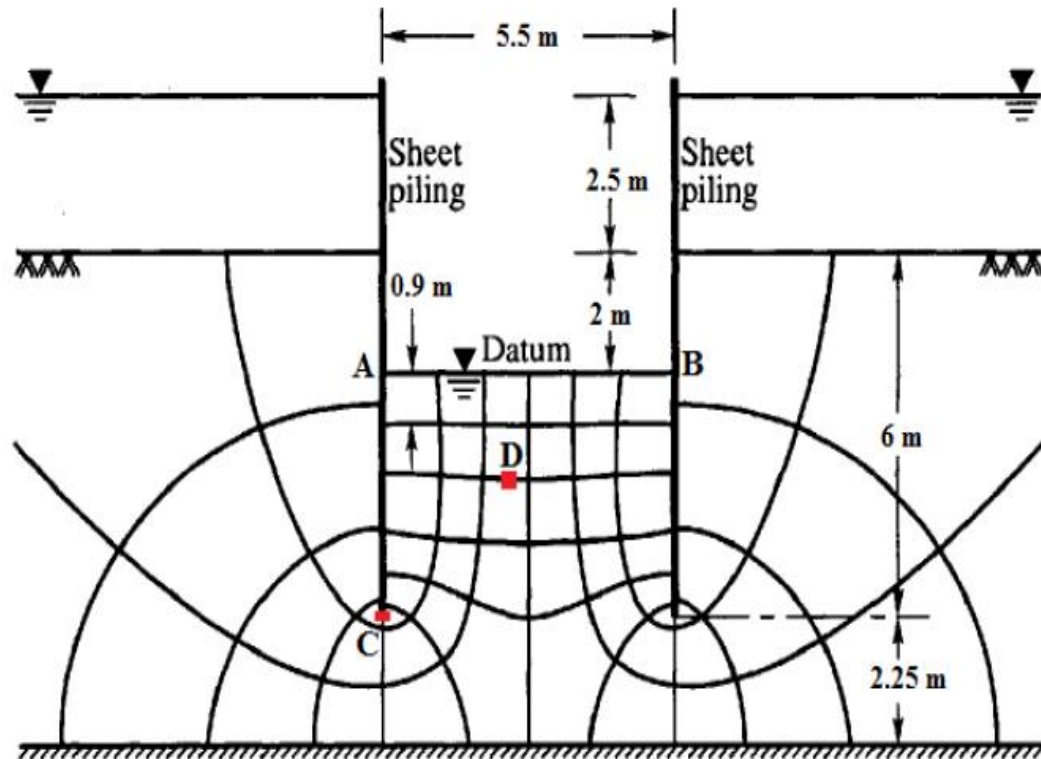

EXAMPLE 6 (Final Exam Fall 38-39)

Required:

- a) The coefficient of permeability of the sand if the flow of water into the cofferdam is $0.25 \text{ m}^3/\text{h}$ per unit length.
- b) The hydraulic gradient immediately below the excavated surface? (i.e. line AB).
- c) The pore water pressure at point C.
- d) The effective stress at point D (located 1.8 m below line AB) if the unit weight of the sand is 18.0 kN/m^3 .
- e) Repeat part (d) if the water level behind the wall is lowered to the ground surface and the water level rises 2.0 above the river bed.

Flow Nets in Anisotropic Soil

Flow Nets in Anisotropic Soil

- The Laplace's equation is based on the assumption that permeability are equal in the **horizontal and vertical** directions.

$$\frac{\partial^2 h}{\partial x^2} + \frac{\partial^2 h}{\partial z^2} = 0$$

- However, most compacted embankments and many natural soil deposits are more or less stratified, often with horizontal bedding that make **horizontal** permeability much **greater** than the vertical.
- The differential equation in **2-D** for seepage through **anisotropic** soil is

$$k_x \frac{\partial^2 h}{\partial x^2} + k_z \frac{\partial^2 h}{\partial z^2} = 0 \quad (*)$$

Flow Nets in Anisotropic Soil

- Eq. (*) is not a Laplace equation and we can no longer obtain solutions to plane seepage problems by drawing “square flow nets”. In this case, Eq. (*) represents two families of curves that do not meet at 90°.

- Eq. (*) can be written as
$$\frac{\partial^2 h}{(k_z / k_x) \partial x^2} + \frac{\partial^2 h}{\partial z^2} = 0 \quad (**)$$

Let $\sqrt{k_z / k_x} \cdot x = \bar{x}$

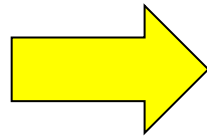

$$\frac{\partial^2 h}{\partial \bar{x}^2} + \frac{\partial^2 h}{\partial z^2} = 0 \quad (***)$$

- Eq. (***) expresses the anisotropic seepage condition as a Laplace equation. Here x is replaced by \bar{x} which is the new transformed coordinate. This equation can be solved exactly as before by square flow nets.
- The x direction is scaled to transform a given anisotropic flow region into a fictitious isotropic flow region in which the Laplace equation is valid.

Flow Nets in Anisotropic Soil

To construct the flow net, the following procedures may be followed:

- Step 1. Adopt a vertical scale (that is, z axis) for drawing the cross section.
- Step 2. Adopt a horizontal scale (that is, x axis) such that horizontal scale = $\sqrt{k_z/k_x} \times$ vertical scale.
- Step 3. With scales adopted as in steps 1 and 2, plot the vertical section through the permeable layer parallel to the direction of flow.
- Step 4. Draw the flow net for the permeable layer on the section obtained from step 3, with flow lines intersecting equipotential lines at right angles and the elements as approximate squares.

The flow through the anisotropic soil is given by

$$q = \sqrt{k'} h \frac{N_f}{N_d}$$

k' = Equivalent coefficient of permeability given by:

$$k' = \sqrt{k_x k_z}$$

The final flow net can be obtained by transforming the cross-section including the flow net back to the natural scale.

Flow Nets in Anisotropic Soil

Remarks

- ✚ In transformed section the flow lines and equipotential lines are orthogonal and the figures are **squares**. However when they redrawn in a true section, they will not intersect at **right angles**, nor will the figures will be squares.
- ✚ If the **horizontal** permeability is **greater** than the **vertical**, the transformed section will always be **shrunk** to a narrower horizontal dimension. If the reverse were true, it will be **longer** than horizontally.

EXAMPLE

A single row of sheet pile structure is shown below. Draw a flow net for the **transformed** section. **Replot** this flow net in the natural scale also. The relationship between the permeabilities is given as $k_x = 6 k_z$.

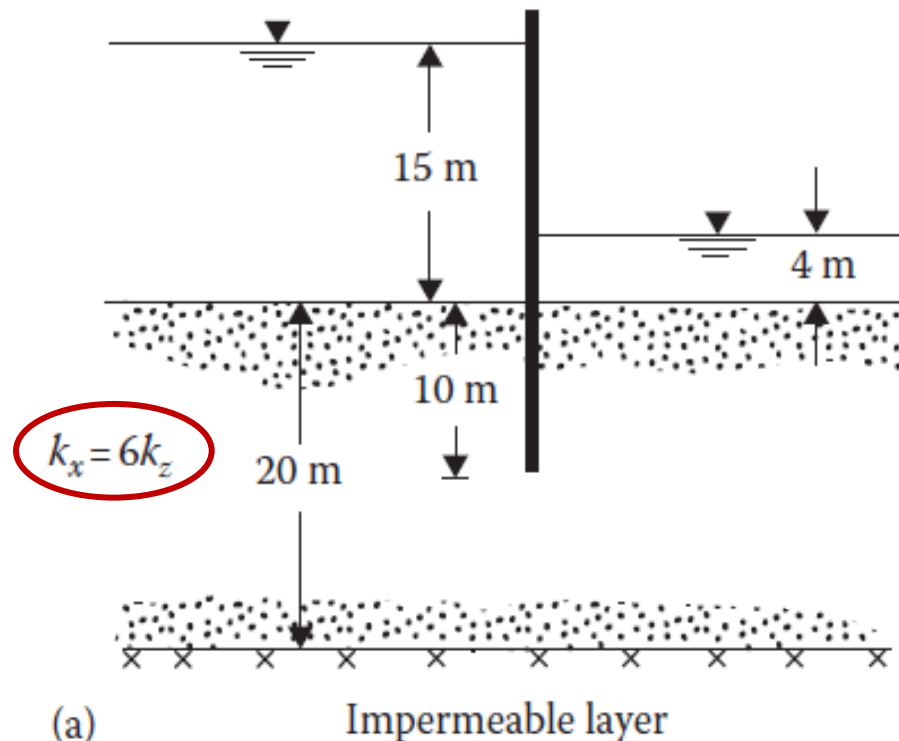

EXAMPLE

Solution

For the transformed section

$$\begin{aligned} \text{Horizontal scale} &= \sqrt{\frac{k_z}{k_x}} (\text{vertical scale}) \\ &= \frac{1}{\sqrt{6}} (\text{vertical scale}) \end{aligned}$$

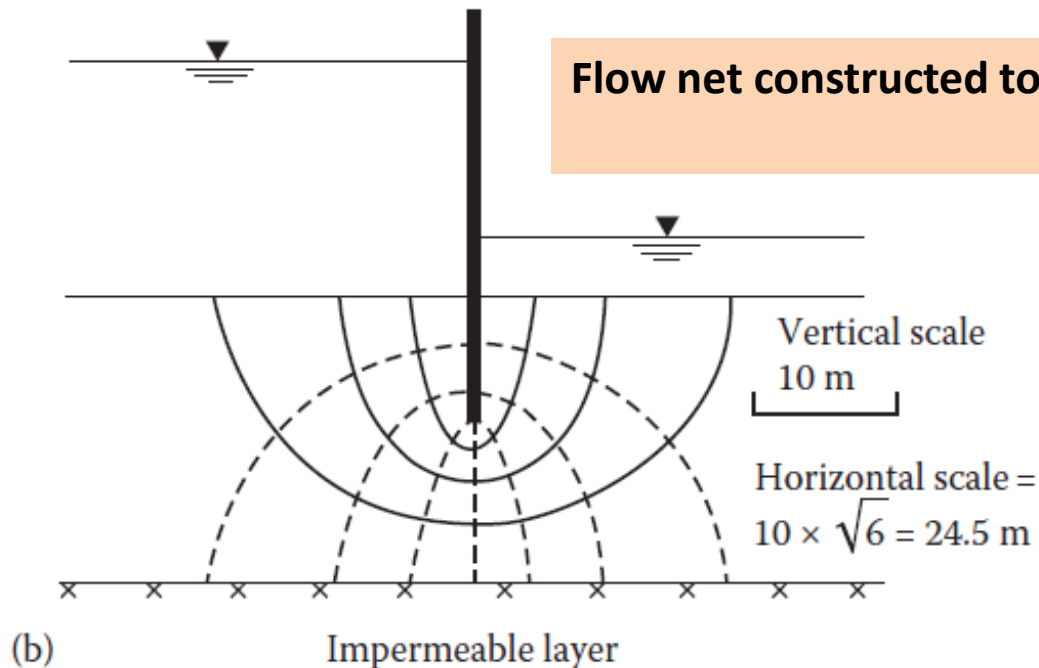

EXAMPLE

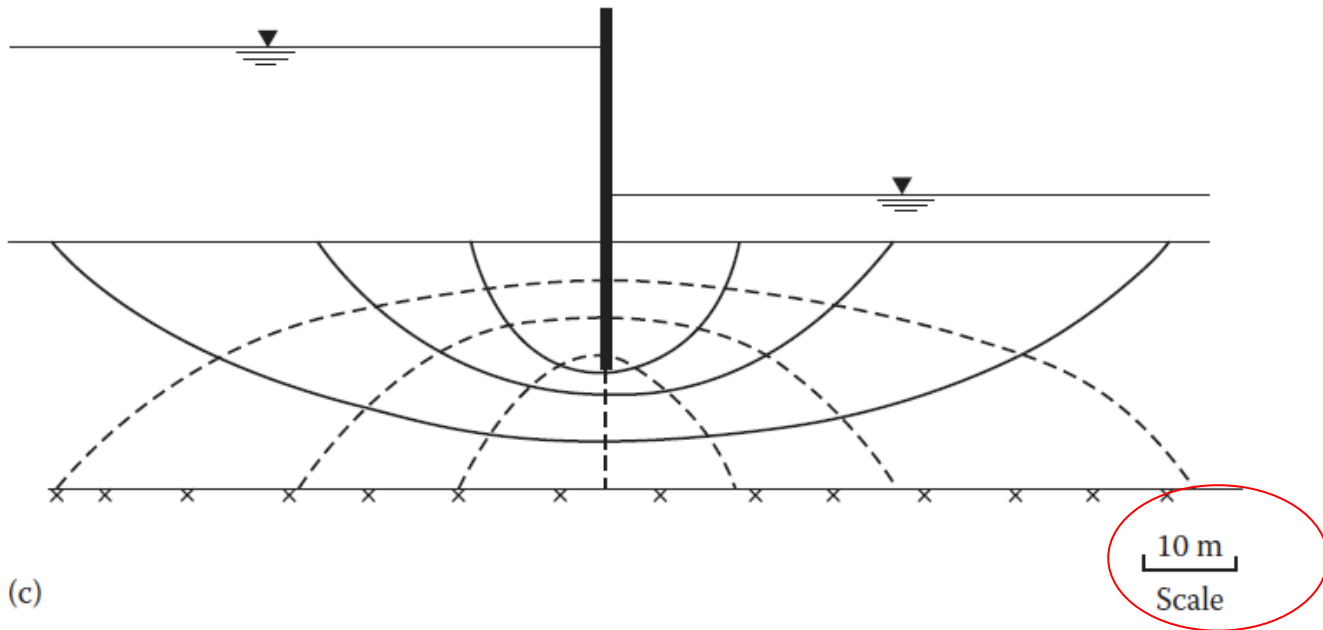

Flow net constructed to the natural scale.

EXAMPLE

A dam section is shown below. The coefficients of permeability of the permeable layer in the **vertical** and **horizontal** directions are 2×10^{-2} and 4×10^{-2} mm/s, respectively.

Draw a flow net and calculate the seepage loss of the dam in $\text{m}^3/(\text{day} \cdot \text{m})$.

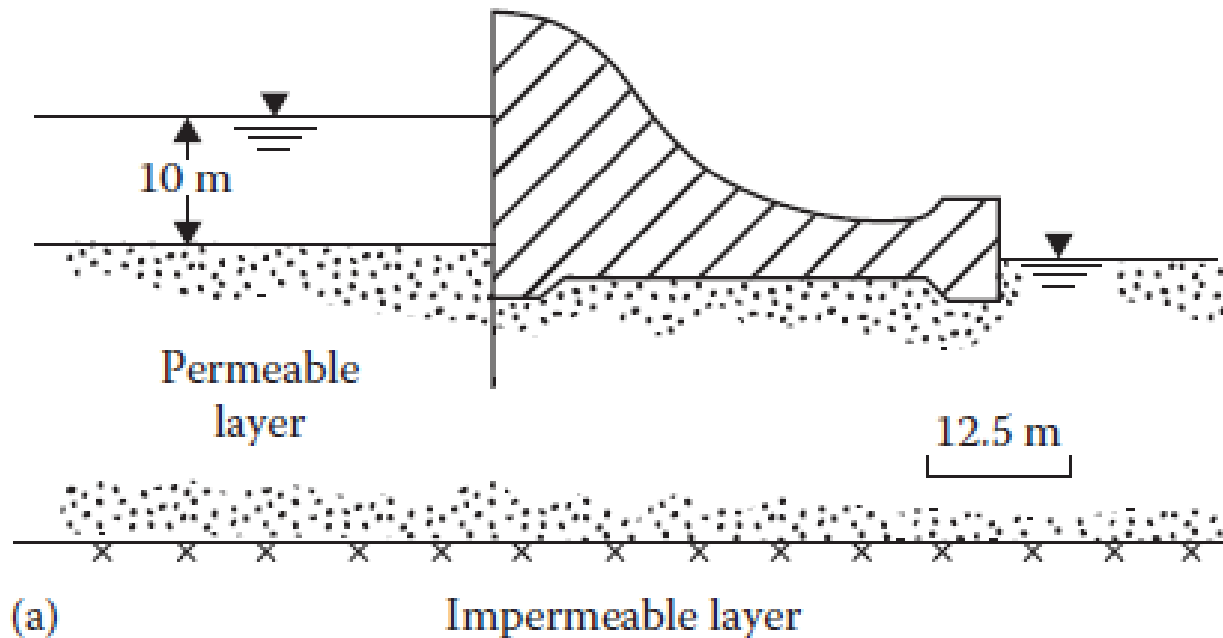

EXAMPLE

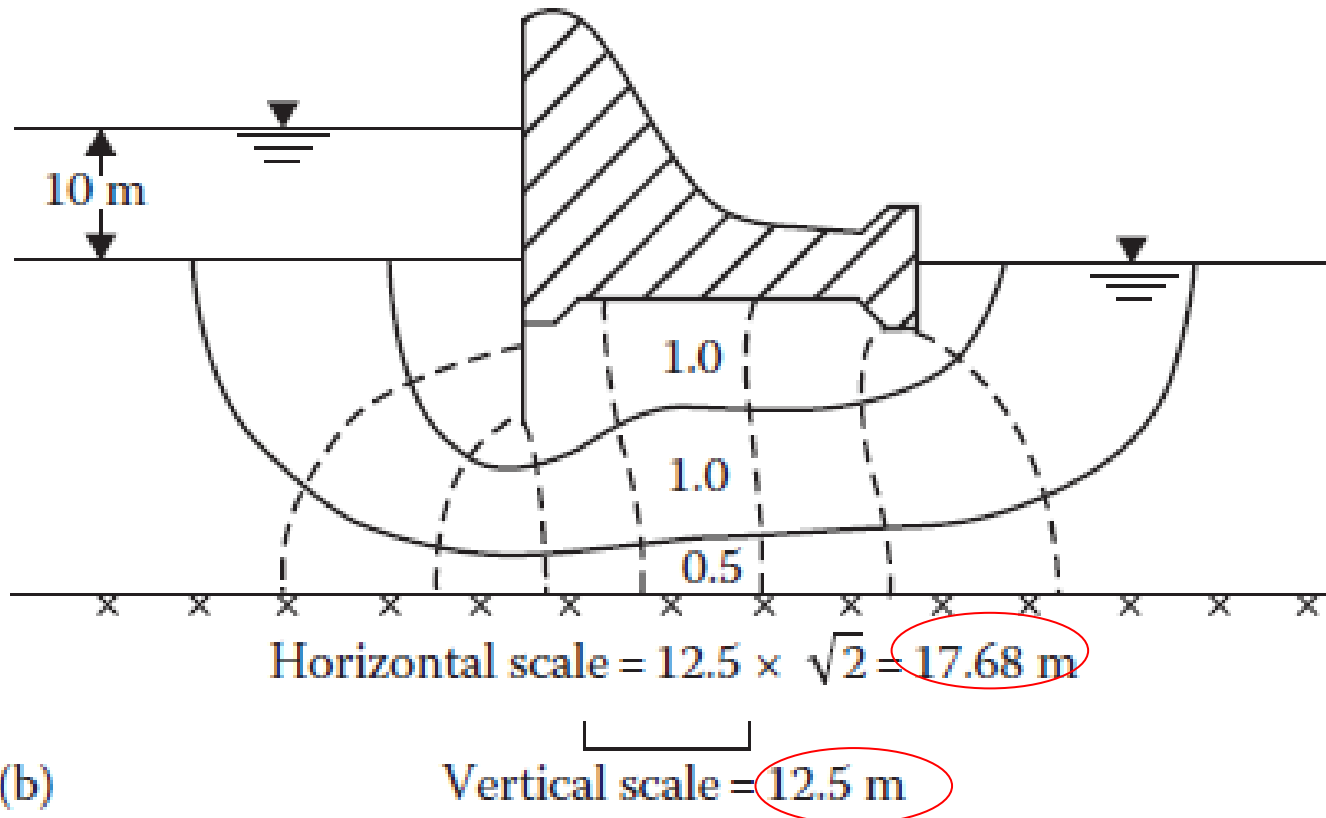

EXAMPLE 8.4

Example 8.4

A dam section is shown in Figure 8.11a. The hydraulic conductivity of the permeable layer in the vertical and horizontal directions are 2×10^{-2} mm/s and 4×10^{-2} mm/s, respectively. Draw a flow net and calculate the seepage loss of the dam in $\text{ft}^3/\text{day}/\text{ft}$

Solution

From the given data,

$$k_z = 2 \times 10^{-2} \text{ mm/s} = 5.67 \text{ ft/day}$$

$$k_x = 4 \times 10^{-2} \text{ mm/s} = 11.34 \text{ ft/day}$$

and $H = 20$ ft. For drawing the flow net,

$$\begin{aligned} \text{Horizontal scale} &= \sqrt{\frac{2 \times 10^{-2}}{4 \times 10^{-2}}} \text{ (vertical scale)} \\ &= \frac{1}{\sqrt{2}} \text{ (vertical scale)} \end{aligned}$$

On the basis of this, the dam section is replotted, and the flow net drawn as in Figure 8.11b. The rate of seepage is given by $q = \sqrt{k_x k_z} H (N_f / N_d)$. From Figure 8.11b, $N_d = 8$ and $N_f = 2.5$ (the lowermost flow channel has a width-to-length ratio of 0.5). So,

$$q = \sqrt{(5.67)(11.34)}(20)(2.5/8) = 50.12 \text{ ft}^3/\text{day}/\text{ft}$$

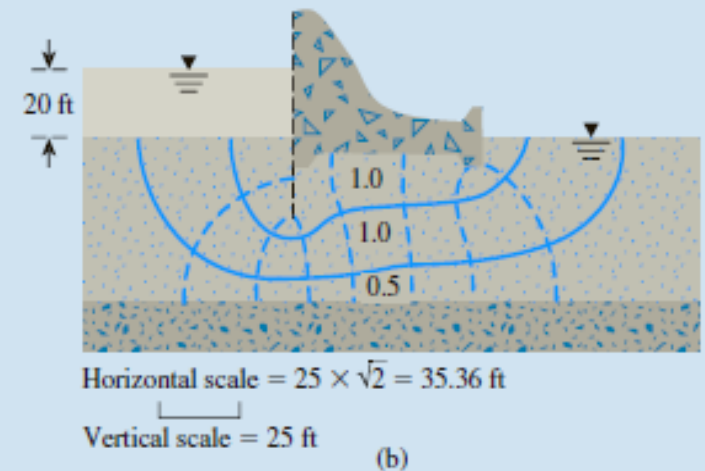
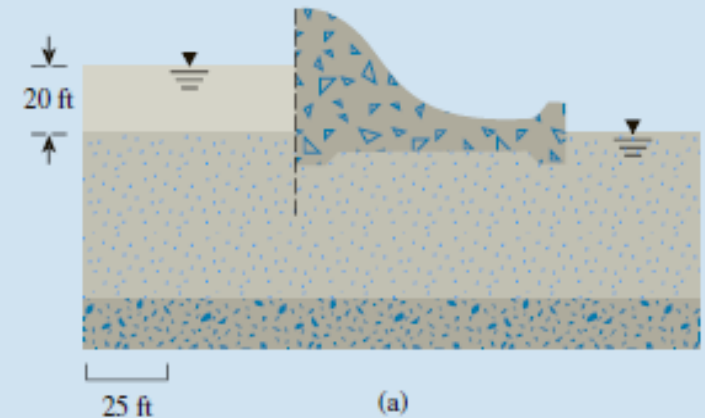

Permeable layer
 Impermeable layer



Mathematical Solution for Seepage

Mathematical Solution for Seepage

Seepage Around a Single Row of Sheet Piles

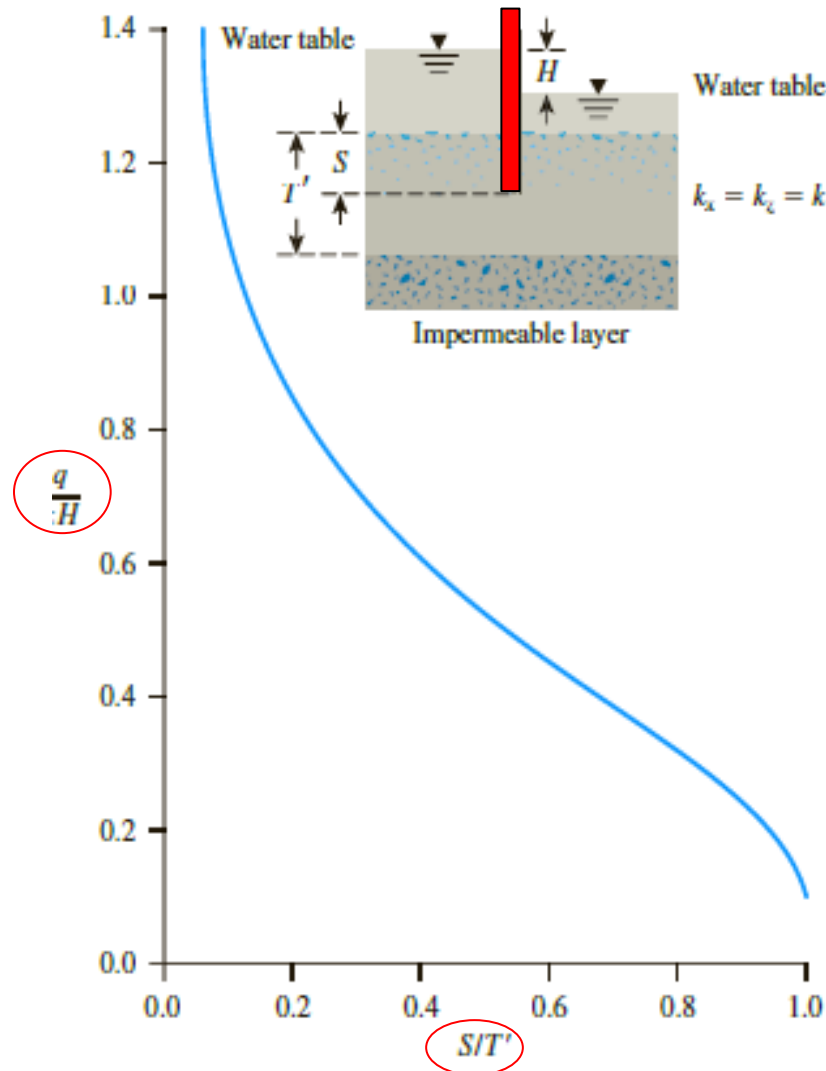

Mathematical Solution for Seepage

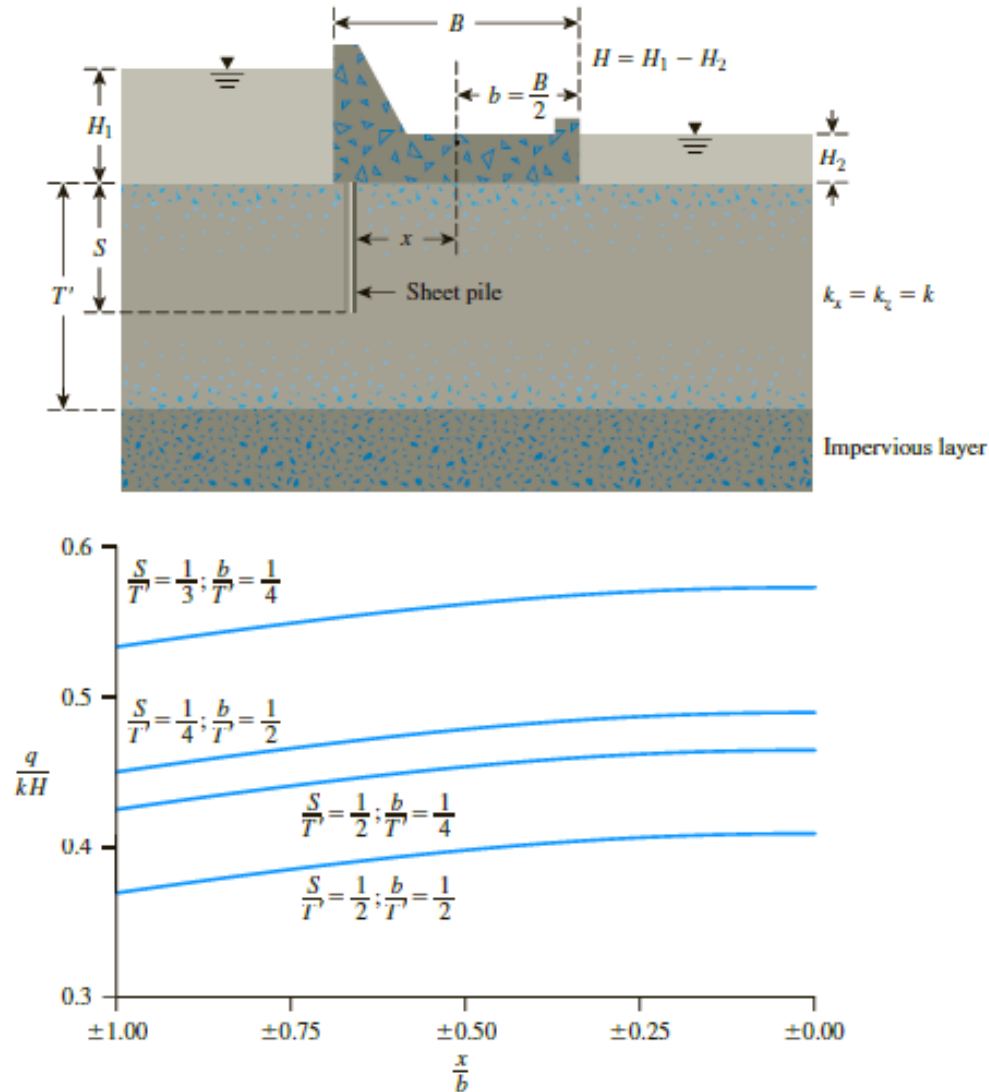

Figure 8.13 Seepage under a dam (After Harr, 1962. By permission of Dover Publications, Inc.)

EXAMPLE 8.5

Example 8.5

Refer to Figure 8.13. Given; the width of the dam, $B = 6$ m; length of the dam, $L = 120$ m; $S = 3$ m; $T' = 6$ m; $x = 2.4$ m; and $H_1 - H_2 = 5$ m. If the hydraulic conductivity of the permeable layer is 0.008 cm/sec, estimate the seepage under the dam (Q) in m^3/day .

Solution

Given that $B = 6$ m, $T' = 6$ m, and $S = 3$ m, so $b = B/2 = 3$ m.

$$\frac{b}{T'} = \frac{3}{6} = 0.5$$

$$\frac{S}{T'} = \frac{3}{6} = 0.5$$

$$\frac{x}{b} = \frac{2.4}{3} = 0.8$$

From Figure 8.13, for $b/T' = 0.5$, $S/T' = 0.5$, and $x/b = 0.8$, the value of $q/kH \approx 0.378$.

Thus,

$$\begin{aligned} Q &= q L = 0.378 k H L = (0.378)(0.008 \times 10^{-2} \times 60 \times 60 \times 24 \text{ m/day})(5)(120) \\ &= \mathbf{1567.64 \text{ m}^3/\text{day}} \end{aligned}$$

Uplift Pressure under Hydraulic Structures

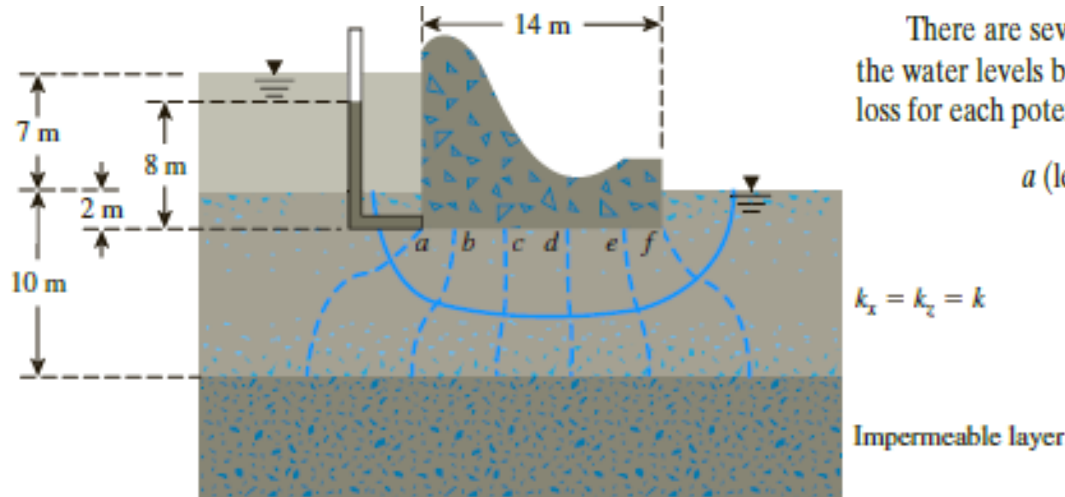

(a)

There are seven equipotential drops (N_d) in the flow net, and the difference in the water levels between the upstream and downstream sides is $H = 7$ m. The head loss for each potential drop is $H/7 = 7/7 = 1$ m. The uplift pressure at

$$\begin{aligned} a \text{ (left corner of the base)} &= (\text{Pressure head at } a) \times (\gamma_w) \\ &= [(7 + 2) - 1]\gamma_w = 8\gamma_w \end{aligned}$$

uplift pressure at

$$b = [9 - (2)(1)]\gamma_w = 7\gamma_w$$

$$f = [9 - (6)(1)]\gamma_w = 3\gamma_w$$

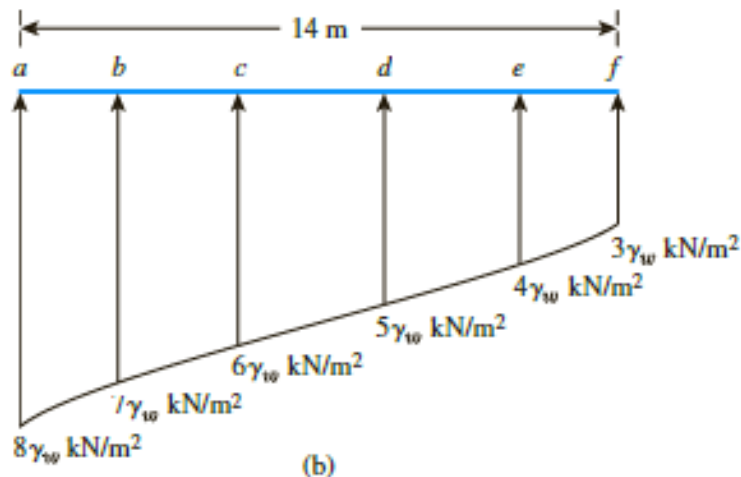

(b)

Example

A stiff clay layer underlies a 12 m thick silty sand deposit. A sheet pile is driven into the sand to a depth of 7 m, and the upstream and downstream water levels are as shown in the figure below.

$$k = 8.6 \times 10^{-6} \text{ m/sec}$$

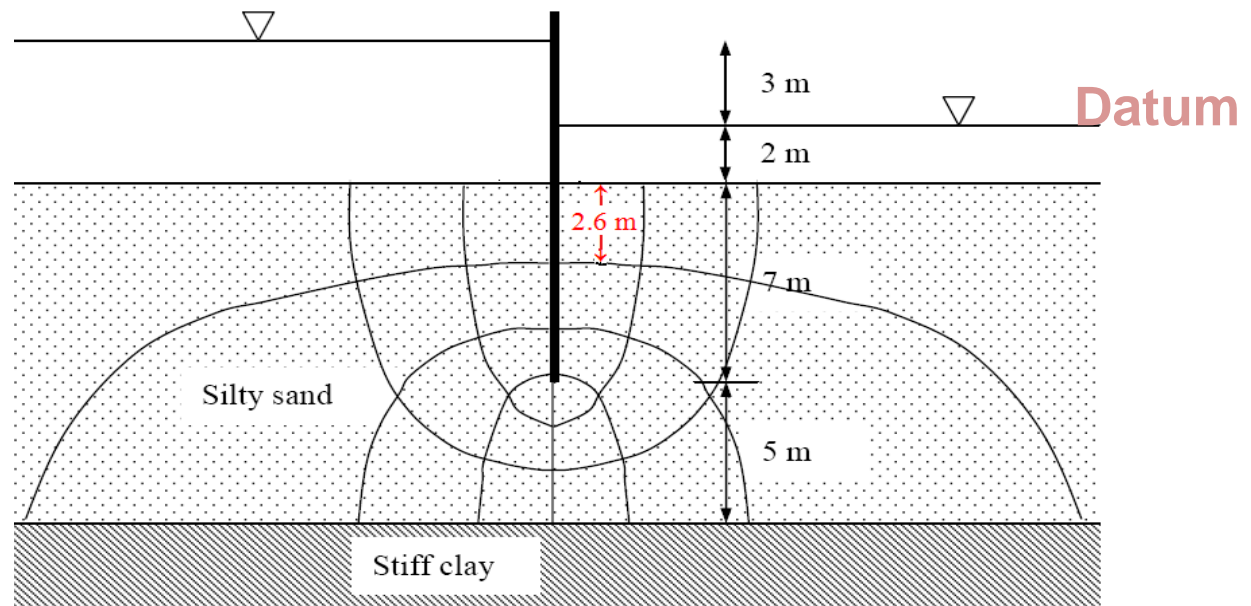

Estimate

a) The seepage beneath the sheet pile in m^3/day per meter.

Example

Recall from flow net $q = 0.836 \text{ m}^3/\text{day}$

$H = 3 \text{ m}$
 $S = 7 \text{ m}$
 $T' = 12 \text{ m}$
 $S/T' = 0.58$

$k = 8.6 \times 10^{-6} \text{ m/sec}$
 $= 0.743 \text{ m/day}$

$q = 0.743 \times 3 \times 0.47 = 0.47$

$q = 1.05 \text{ m}^3/\text{day}$

Difference = ?

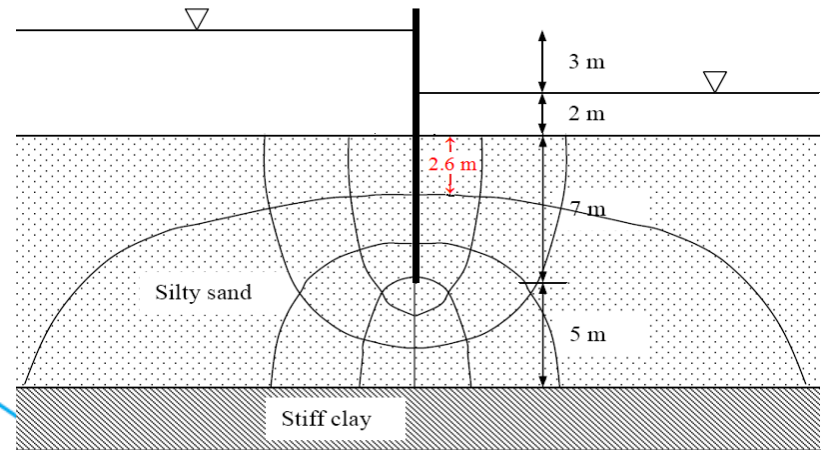
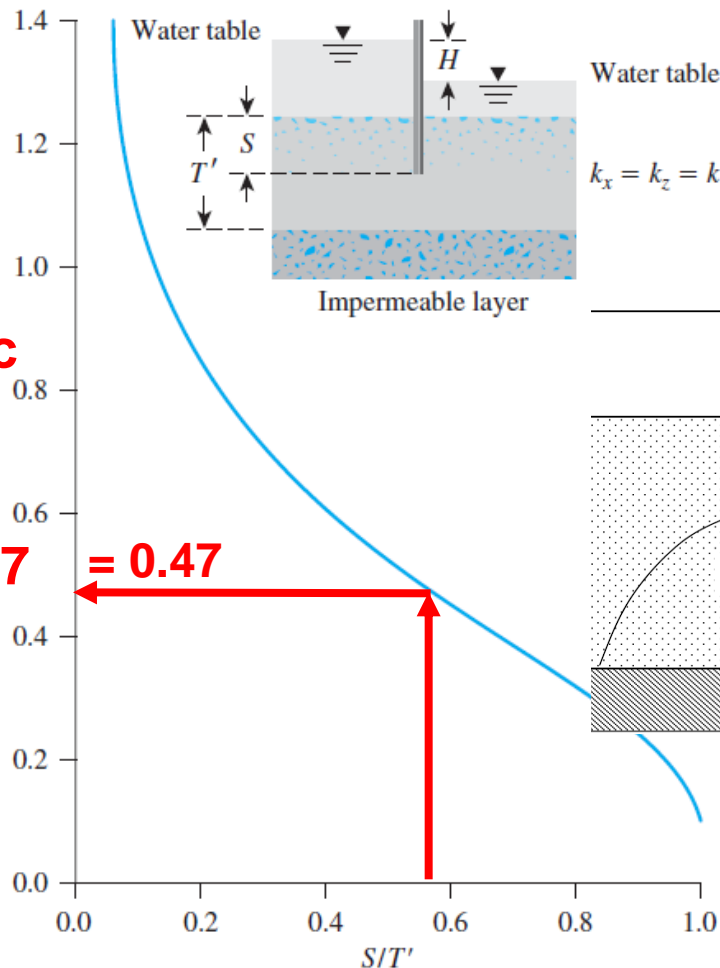
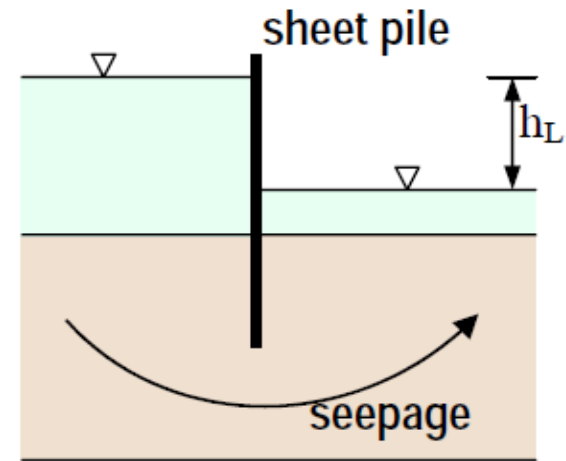
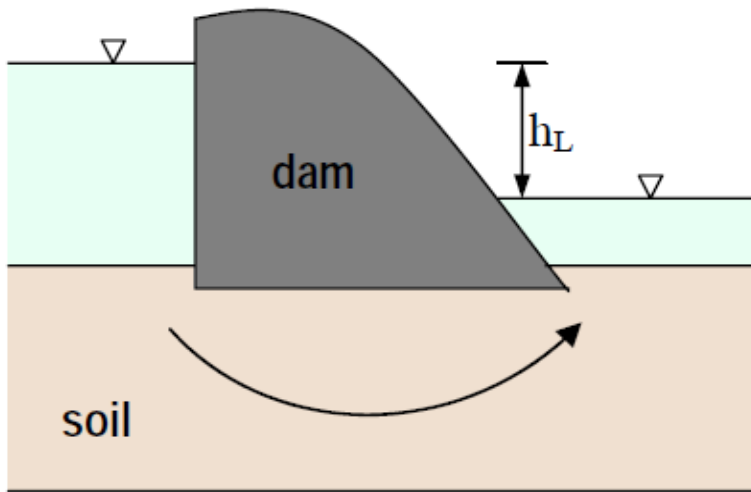

Figure 8.10 Plot of q/kH against S/T' for flow around a single row of sheet piles (After Harr, 1962. By permission of Dover Publications, Inc.)



**FLOW THROUGH EARTH DAMS
RESTING ON AN IMPERVIOUS BASE**

Confined Flow



Seepage beneath (a) a concrete dam (b) a sheet pile

Unconfined Flow

- Seepage through **earth dams** is an example of unconfined seepage.

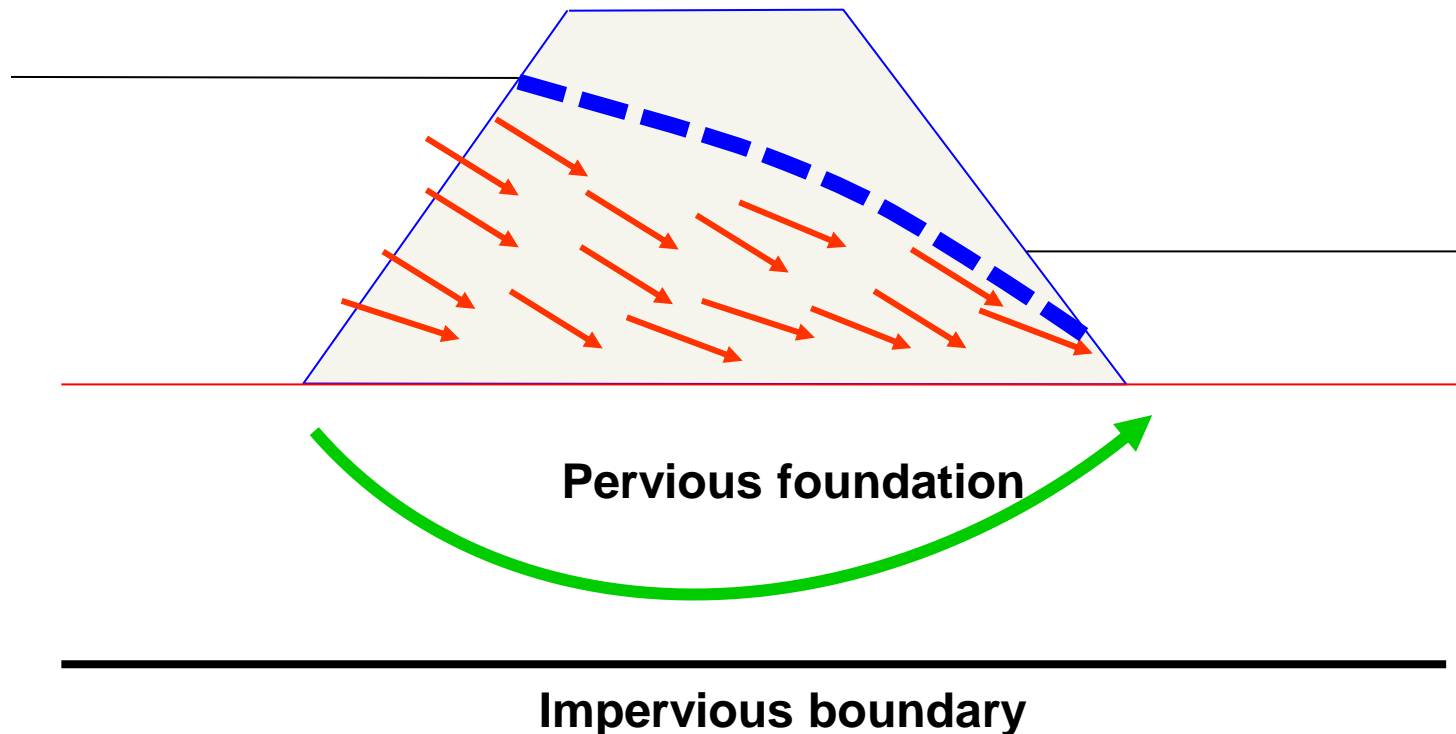

Earth fill dam with flow through both the dam and the foundation

What we will consider?

- We will consider a section of a **trapezoidal** dam of **homogeneous** soils.
- For simplicity it is assumed that the dam rests on **impervious** foundation and that all seepage water therefore flows through the **dam**. (opposite of concrete dam).
- Then the line of contact with the foundation is one boundary flow line.

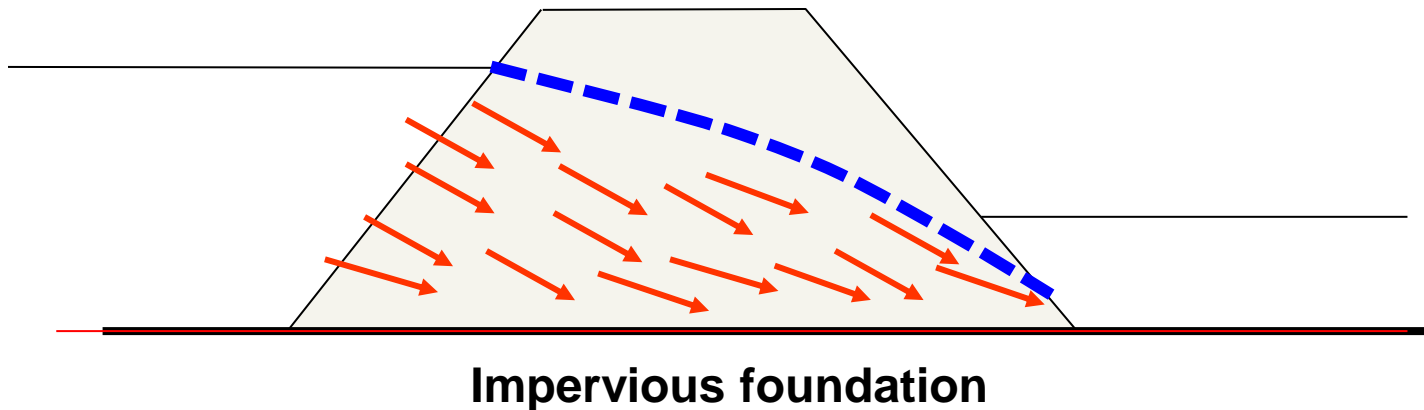

Earth fill dam with flow through the dam only

FLOW THROUGH EARTH DAMS

- The major problem is to establish the shape of the **top line** of seepage.

- The location of the free surface depends on the **flow regime** and the **flow regime** depends on its turn on the position of the free surface.

- Several procedures for obtaining the top flow line are available.

- Unconfined flow problems are often considered more difficult to analyze because the determination of the location of the phreatic surface.

FLOW THROUGH EARTH DAMS

Schaffernak's (1917), Casagrande (1937)

Considering the triangle *cde*, we can give the rate of seepage per unit length of the dam (at right angles to the cross section shown in Figure) as:

$$i \approx \frac{dz}{dx}$$

$$q = kiA$$

$$i = \frac{dz}{dx} = \tan \alpha$$

$$A = (\overline{ce})(1) = L \sin \alpha$$

Consider Plane ce

$$q = k(\tan \alpha)(L \sin \alpha) = kL \tan \alpha \sin \alpha \quad (*)$$

Rate of seepage (per unit length of the dam) through the section *bf* is

$$q = kiA = k\left(\frac{dz}{dx}\right)(z \times 1) = kz \frac{dz}{dx} \quad (**)$$

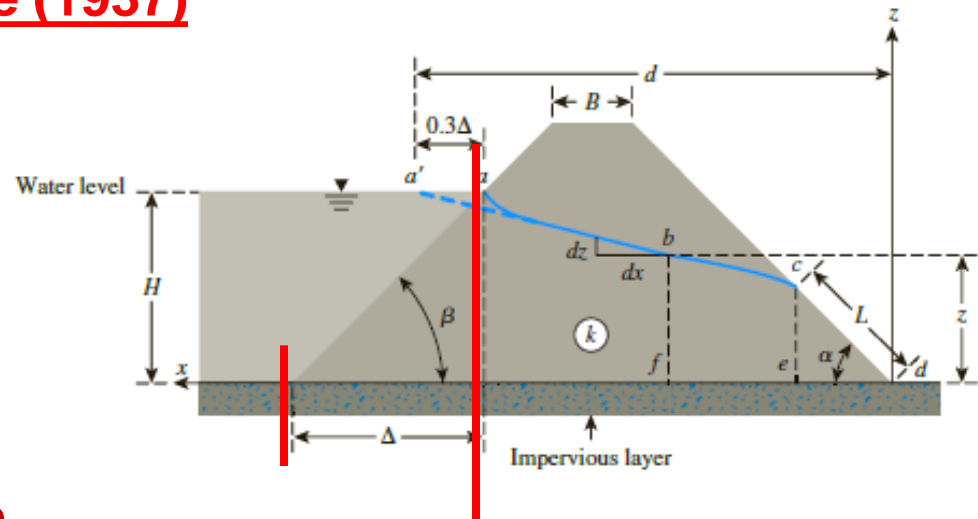

For continuous flow,

$$\text{Eq } (*) = \text{Eq } (**)$$

$$kz \frac{dz}{dx} = kL \tan \alpha \sin \alpha$$

$$\int_{z=L \sin \alpha}^{z=H} kz \, dz = \int_{x=L \cos \alpha}^{x=d} (kL \tan \alpha \sin \alpha) \, dx$$

$$L = \frac{d}{\cos \alpha} - \sqrt{\frac{d^2}{\cos^2 \alpha} - \frac{H^2}{\sin^2 \alpha}} \quad (***)$$

FLOW THROUGH EARTH DAMS

Following is a step-by-step procedure to obtain the seepage rate q (per unit length of the dam):

Step 1. Obtain α .

Step 2. Calculate Δ (from Figure) and then 0.3Δ .

Step 3. Calculate d .

Step 4. With known values of α , H and d , calculate L from Eq. (***)

$$L = \frac{d}{\cos \alpha} - \sqrt{\frac{d^2}{\cos^2 \alpha} - \frac{H^2}{\sin^2 \alpha}} \quad (***)$$

Step 5. With known value of L , calculate q from Eq. (*)

$$q = k(\tan \alpha)(L \sin \alpha) = kL \tan \alpha \sin \alpha \quad (*)$$

FLOW THROUGH EARTH DAMS

L. Casagrande's Solution for Seepage through an Earth Dam

- Equation (***) is derived on the basis of Dupuit's assumption (i.e., $i < dz/dx$).
- when the downstream slope angle becomes greater than 30° , deviations from Dupuit's assumption become more noticeable

$$i = \frac{dz}{ds} = \sin \alpha$$

where $ds = \sqrt{dx^2 + dz^2}$.

Eq. (*) becomes

$$q = kiA = k \sin \alpha (L \sin \alpha) = kL \sin^2 \alpha \quad (***)$$

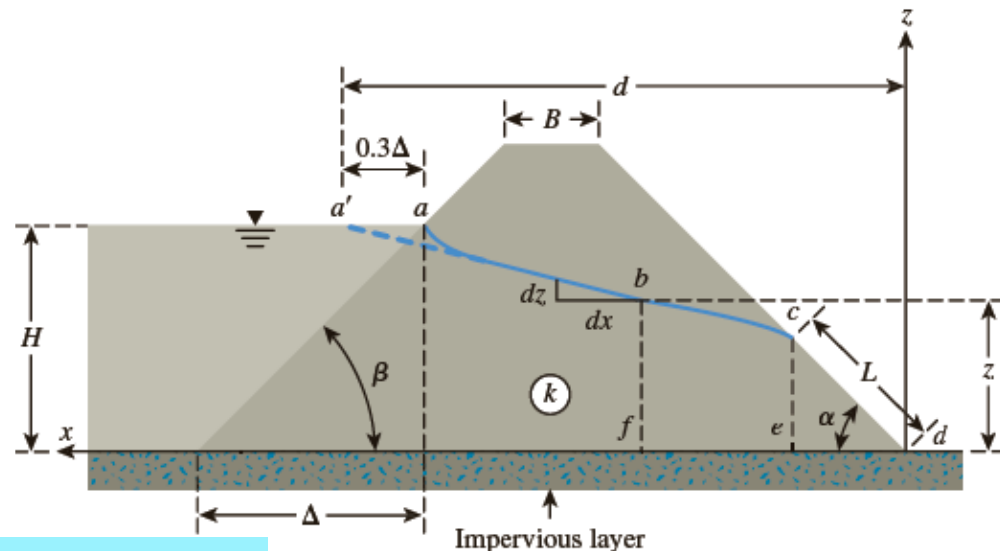

FLOW THROUGH EARTH DAMS

L. Casagrande's Solution for Seepage through an Earth Dam

$$q = kiA = k \left(\frac{dz}{ds} \right) (1 \times z)$$

$$Q_{(Eq^{**})} = Q_{(Eq^{****})}$$

$$\int_{L \sin \alpha}^H z \, dz = \int_L^s L \sin^2 \alpha \, ds \quad \longrightarrow \quad L = s - \sqrt{s^2 - \frac{H^2}{\sin^2 \alpha}}$$

where s is the length of the curve $a'bc$

With about a 4–5% error, the dimension s differs only slightly from the straight line $a'c$. Therefore, the distance s is approximated as

$$s = \sqrt{d^2 + H^2}$$

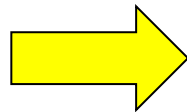

$$L = \sqrt{d^2 + H^2} - \sqrt{d^2 - H^2 \cot^2 \alpha}$$

$$q = kL \sin^2 \alpha$$

Alternative graphical procedure for obtaining L

Solution by L. Casagrande's method based on Gilboy's solution

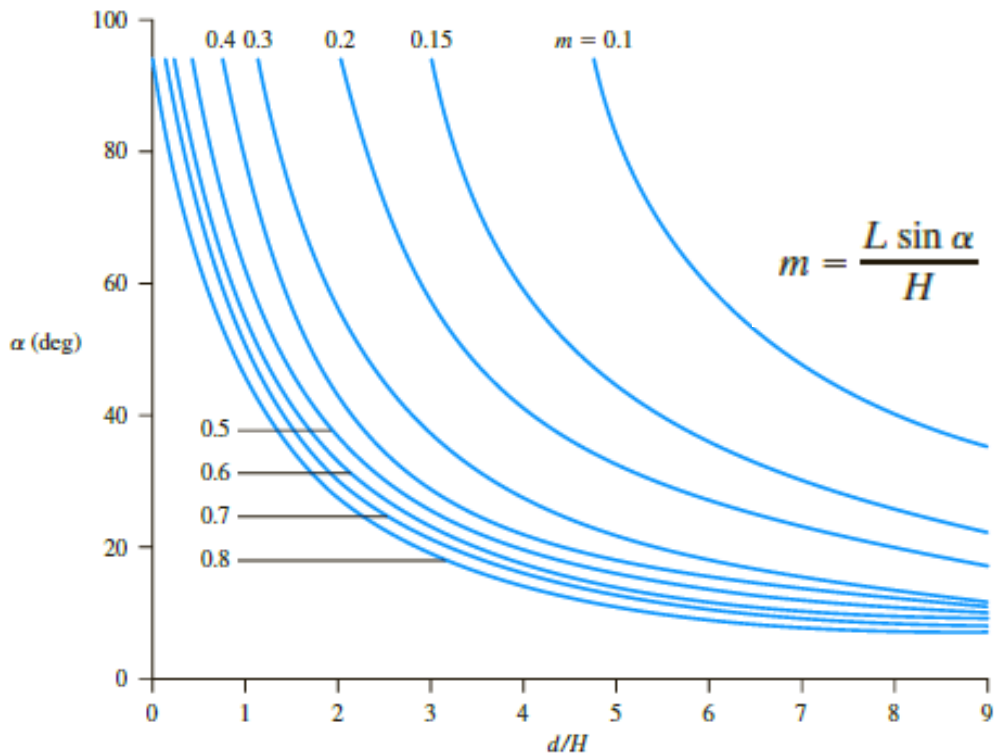

In order to use the graph,

- Step 1.** Determine d/H .
- Step 2.** For a given d/H and α , determine m .
- Step 3.** Calculate $L = \frac{mH}{\sin \alpha}$.
- Step 4.** Calculate $q = kL \sin^2 \alpha$.

L. Casagrande's (1932) Solution

$$q = kL \sin^2 \alpha$$

- Approximate solution for L

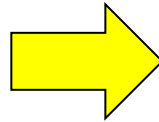

$$L = \sqrt{d^2 + H^2} - \sqrt{d^2 - H^2 \cot^2 \alpha}$$

-
- Graphical solution for L

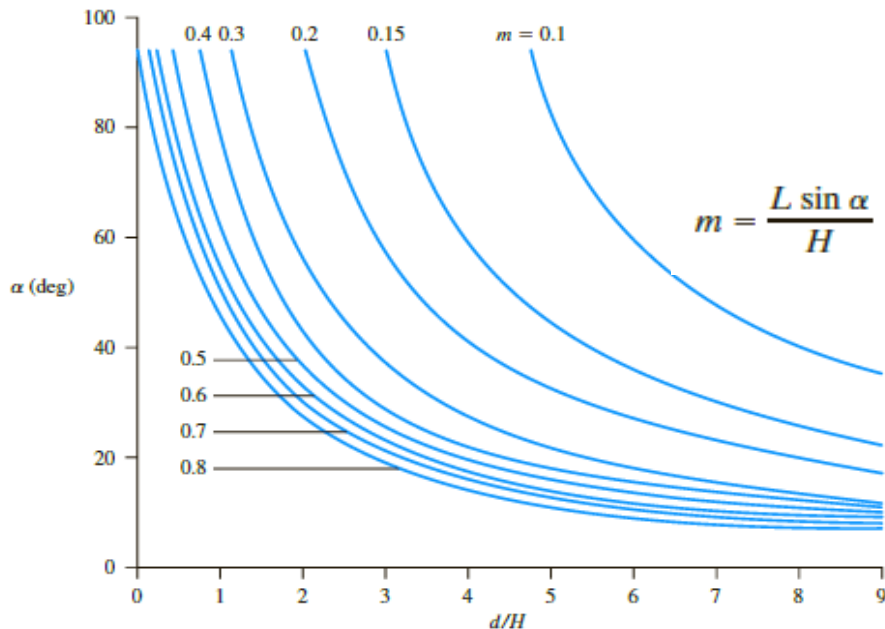

In order to use the graph,

- Step 1. Determine d/H .
- Step 2. For a given d/H and α , determine m .
- Step 3. Calculate $L = \frac{mH}{\sin \alpha}$.
- Step 4. Calculate $q = kL \sin^2 \alpha$.



Piping Failures

Piping Failures



Exit Hydraulic Gradient

At the downstream, near the dam,

$$\text{the exit hydraulic gradient } i_{exit} = \frac{\Delta h}{\Delta l}$$

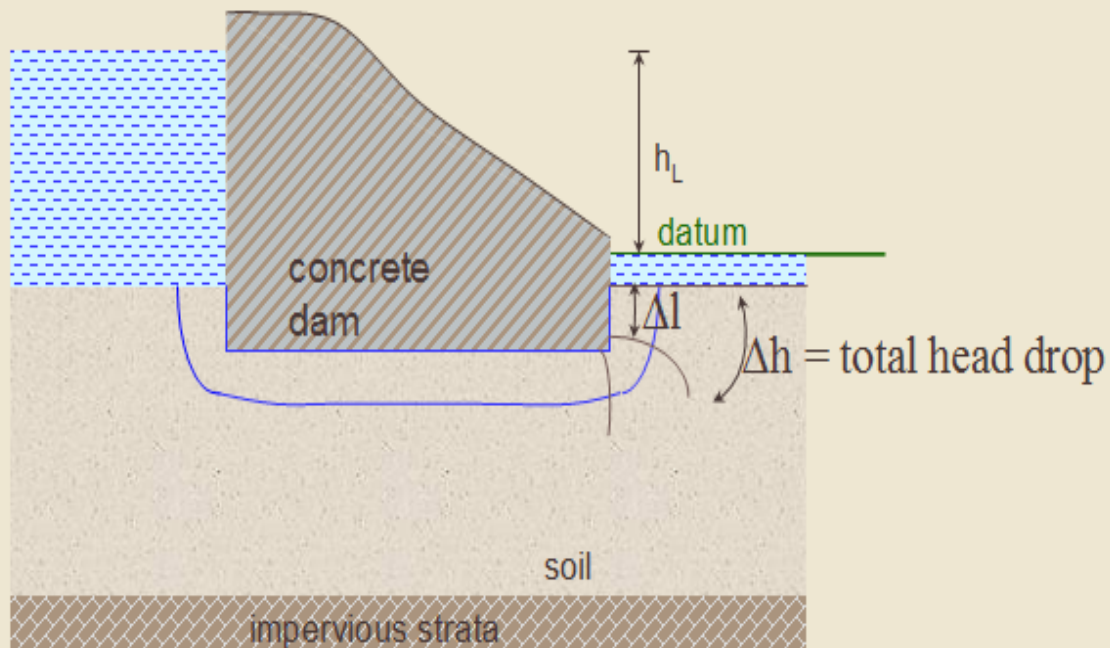

Critical Hydraulic Gradient

- The critical hydraulic gradient (i_c), is given by

$$i_c = \frac{\gamma'}{\gamma_w} = \frac{G_s - 1}{1 + e}$$

- If exit gradient is greater than critical hydraulic gradient:

Consequences:

no stress to hold granular soils together

∴ soil may flow ⇒

“boiling” or “piping” = EROSION

Critical Hydraulic Gradient

If i_{exit} exceeds the critical hydraulic gradient (i_c), firstly the soil grains at exit get washed away.

This phenomenon progresses towards the upstream, forming a free passage of water ("pipe").

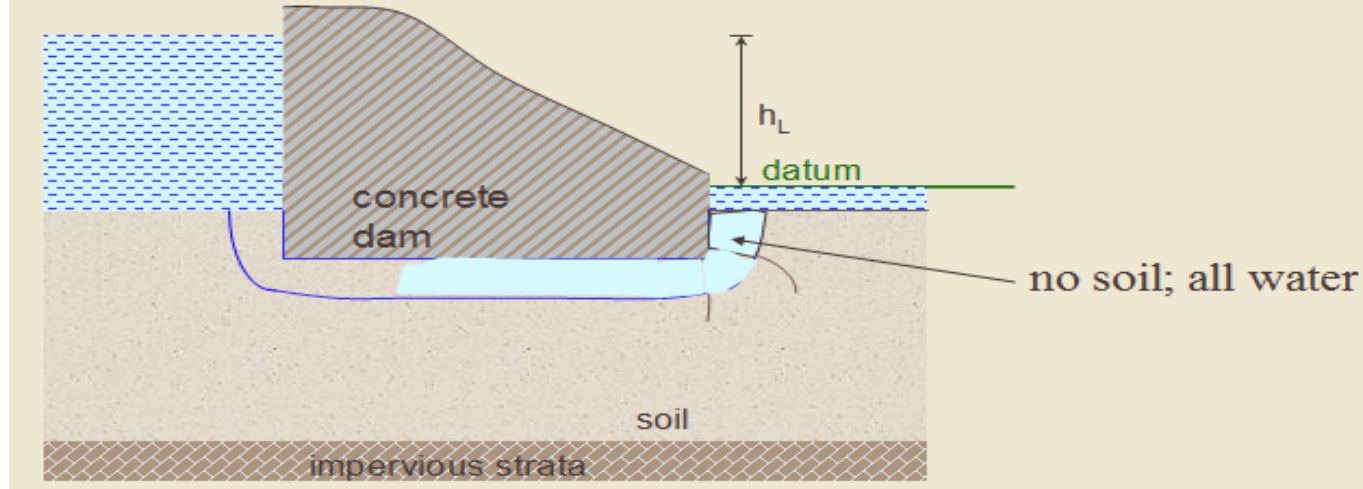

Factor against piping

$$F_{\text{piping}} = \frac{i_c}{i_{\text{exit}}}$$

Typically 5 to 6

Note: we use high value for the factor of safety because of the disastrous consequences of failure.

Example

Exit gradient in the last “square”

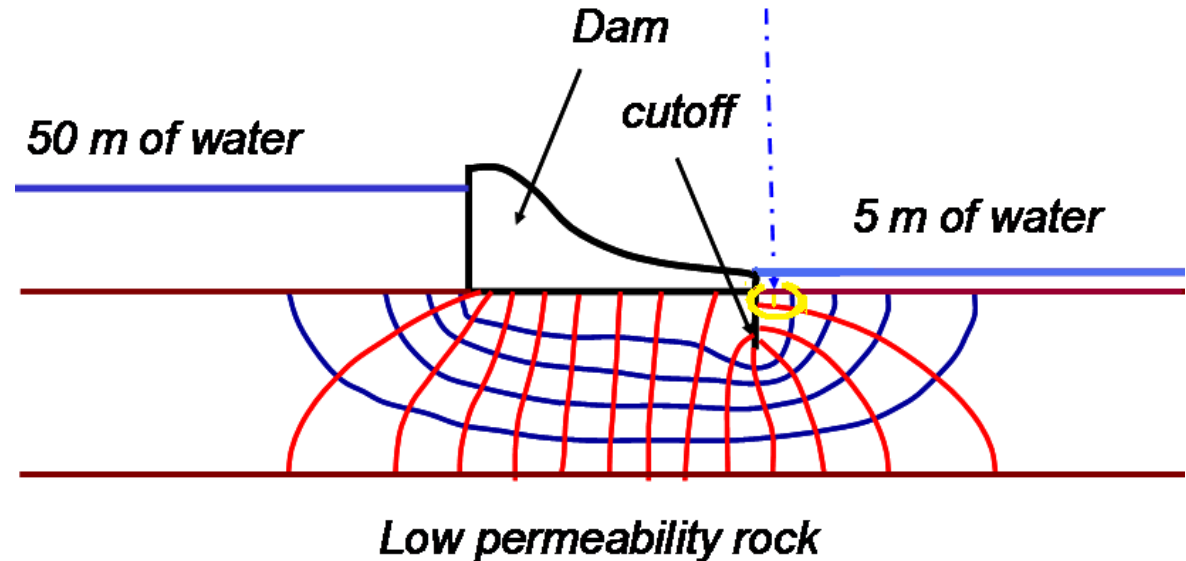

Is the arrangement safe against piping?

✚ $[h / N_d] = 45/14 = 3.2 \text{ m head per drop}$

✚ Average length of last element is about 3 m

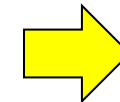

$i_{\text{exit}} = 3.2/3 \approx 1.1$

$$i_c = \frac{\gamma'}{\gamma_w} = \frac{G_s - 1}{1 + e}$$

✚ For most soils $0.9 < i_c < 1.1$ with an average of 1.0.

✚ $F_{\text{piping}} = 1/1.1 \approx 0.9$



Very dangerous

Example

A stiff clay layer underlies a 12 m thick silty sand deposit. A sheet pile is driven into the sand to a depth of 7 m, and the upstream and downstream water levels are as shown in the figure below.

$k = 8.6 \times 10^{-6} \text{ cm/sec}$
 $e = 0.72$
 $G_s = 2.65$

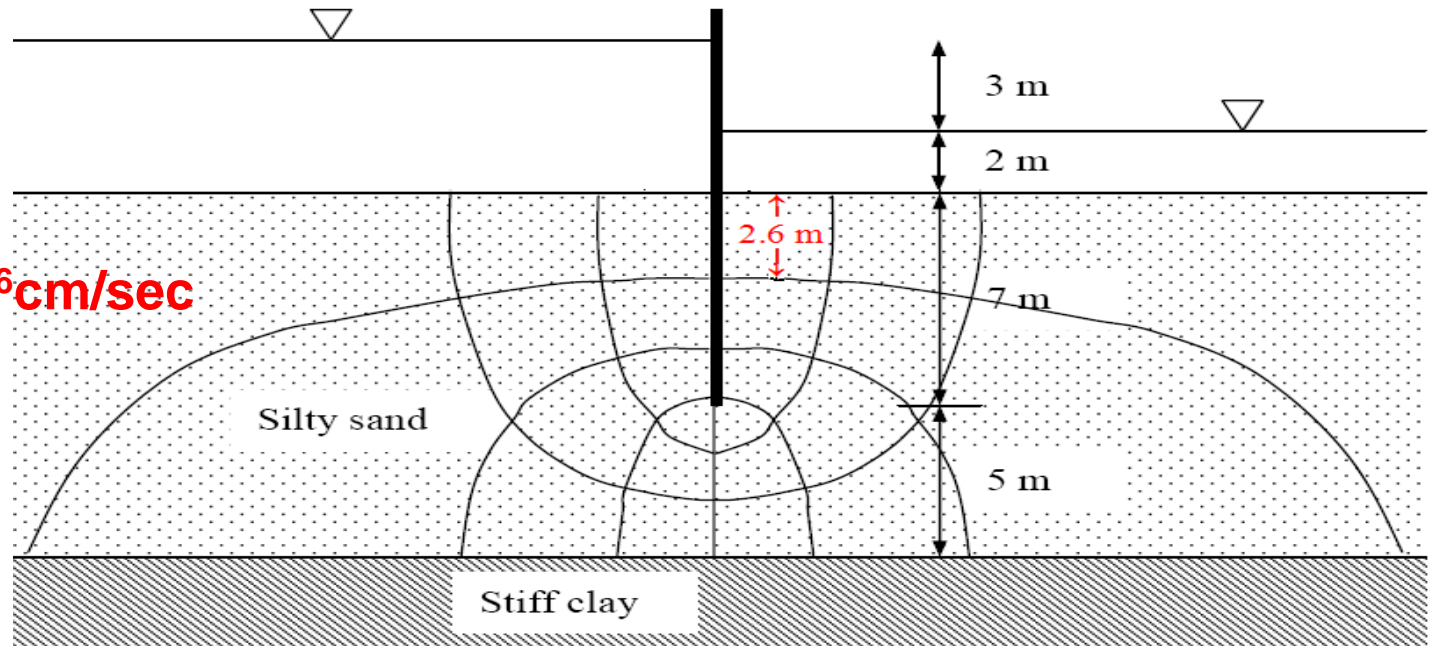

Required

Is the arrangement safe against piping?

Example

$$e = 0.72$$
$$G_s = 2.65$$

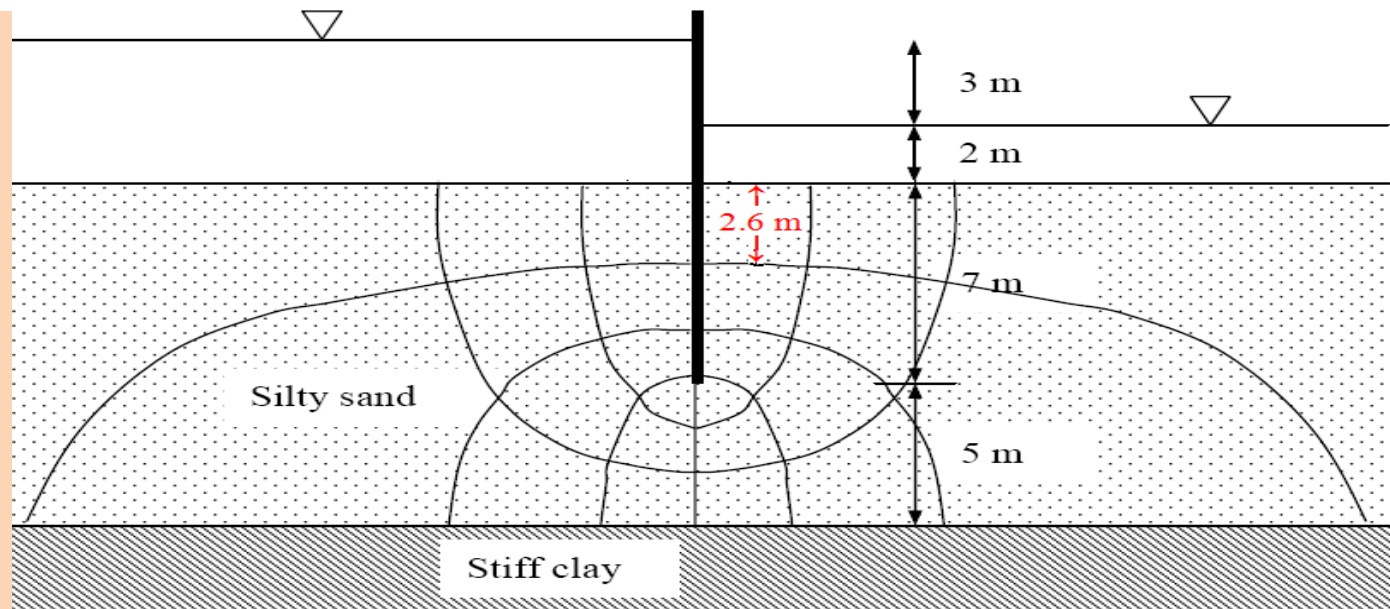

- (c) Head loss per equipotential drop, $\Delta h = 3/8 = \underline{0.375 \text{ m}}$
The maximum exit hydraulic gradient (near the sheet pile) = $0.375/2.6 = \underline{0.144}$
The critical hydraulic gradient (i_c) is given by:

$$i_c = \frac{G_s - 1}{1 + e} = \frac{2.65 - 1}{1 + 0.72} = \underline{0.96}$$

\therefore Safety factor with respect to piping $F = 0.96/0.144 = 6.7 > 5$

The arrangement is quite safe with respect to piping.

Preventing Piping

- As mentioned previously, **piping** and **erosion** are a possibility if, somewhere in the porous medium, the **gradient** exceeded the **critical** gradient.
- Piping can occur any place in the system, but usually it occurs where **the flow is concentrated**.
- We may have:
 - **Washing** of the fine material or
 - **Clogging** of voids and buildup of p.w.p.

Filters

- There are several methods to control seepage and to prevent erosion and piping, one of which is to use a protective filter.
- A properly designed coarser material is called a **FILTER**.
- A filter consists of one or more layers of **free-draining granular** materials placed in less pervious foundation or base materials to:
 - **Prevent the movement** of soil particles that are susceptible to piping.
 - While at the same time **allowing the seepage water** to escape with relatively little head loss.

Filters

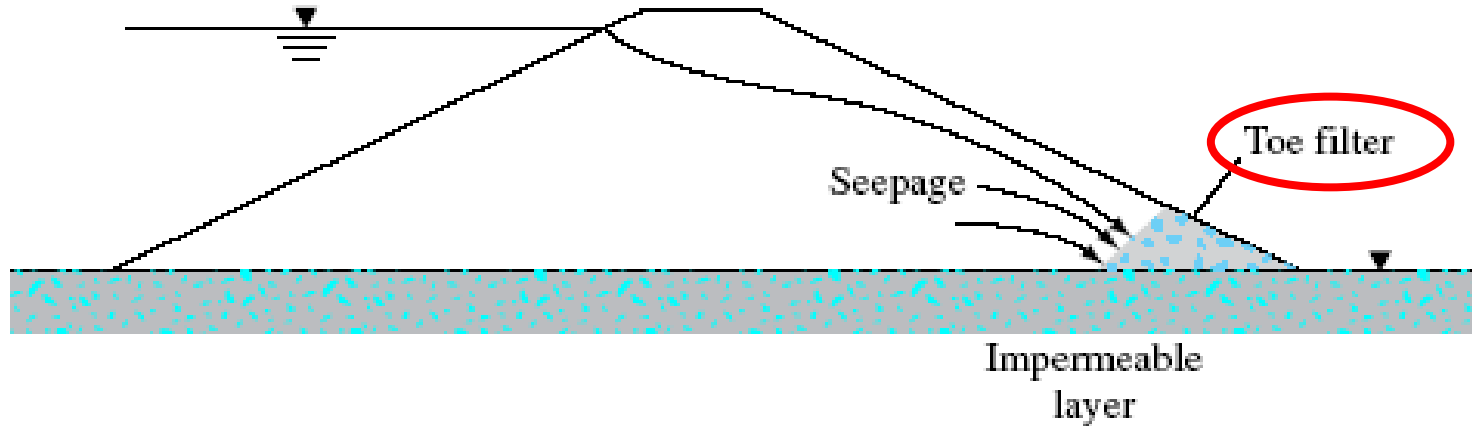

Steady-state seepage in an earth dam with a toe filter

Filters used for:

- Facilitating drainage
- preventing fines from being washed away

Used in:

- Earth dams
- Retaining walls

Filter Materials:

- Granular soils
- Geotextiles

Filters

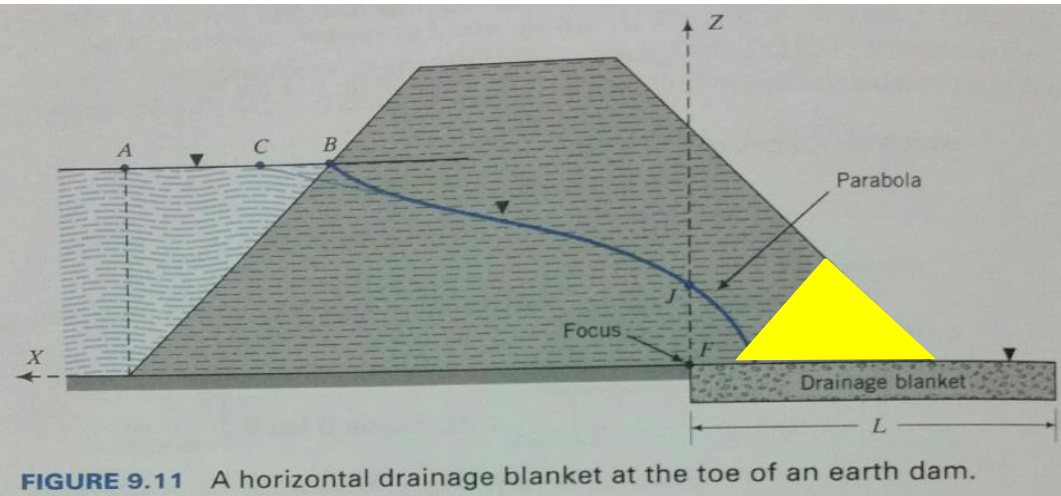

Dams with Triangular Toe Drain

Dams with Drainage Blanket

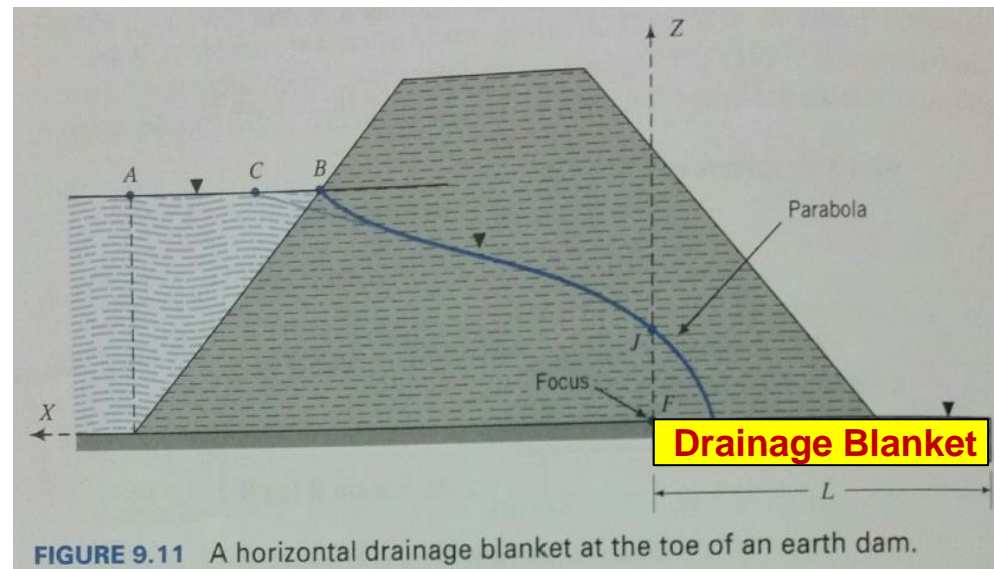

Filter Design

Two major criteria:

(a) Retention Criteria

- to prevent washing out of fines

∴ Filter grains must not be too coarse

(b) Permeability Criteria

- to facilitate drainage and thus avoid build-up of pore pressures

∴ Filter grains must not be too fine

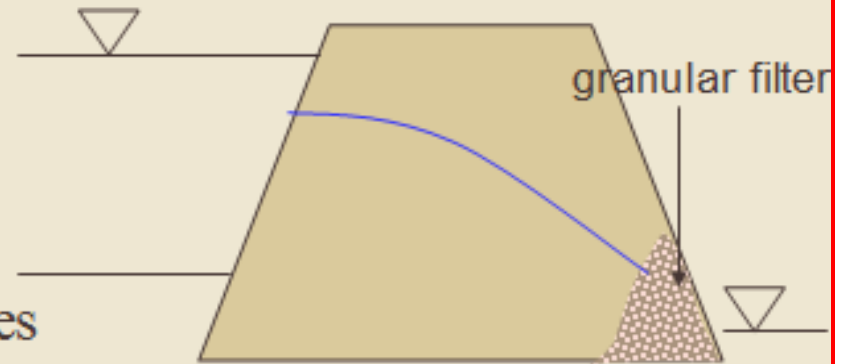

Filters

For proper selection of the filter material, two conditions should be kept in mind:

Condition 1. The size of the voids in the filter material should be small enough to hold the larger particles of the protected material in place.

Condition 2. The filter material should have a high hydraulic conductivity to prevent buildup of large seepage forces and hydrostatic pressures in the filters.

$$\text{If } D_{LS} > 6.5D_{SS}$$

The small sphere can move through the void spaces of the larger one.

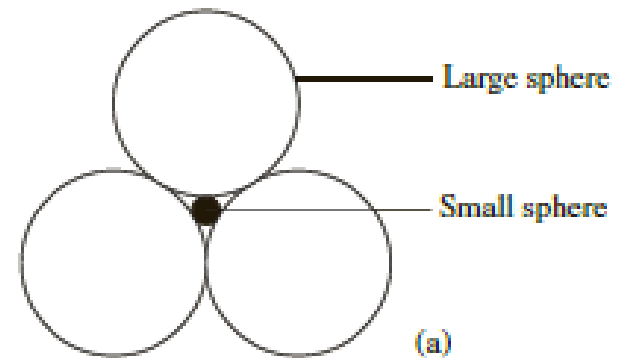

Large spheres with diameters of 6.5 times the diameter of the small sphere;

Filters

$$\frac{D_{15(F)}}{D_{85(S)}} \leq 4 \text{ to } 5 \quad (\text{to satisfy Condition 1})$$

$$\frac{D_{15(F)}}{D_{15(S)}} \geq 4 \text{ to } 5 \quad (\text{to satisfy Condition 2})$$

where $D_{15(F)}$ = diameter through which 15% of filter material will pass
 $D_{15(S)}$ = diameter through which 15% of soil to be protected will pass
 $D_{85(S)}$ = diameter through which 85% of soil to be protected will pass

Terzaghi and Peck (1948)

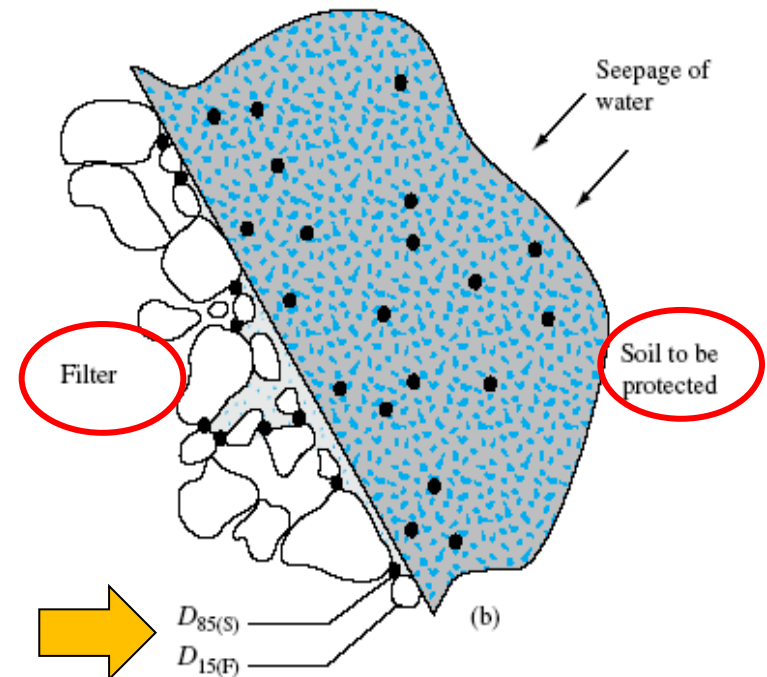

The acceptable grain-size distribution of the filter material will have to lie within the shaded zone.

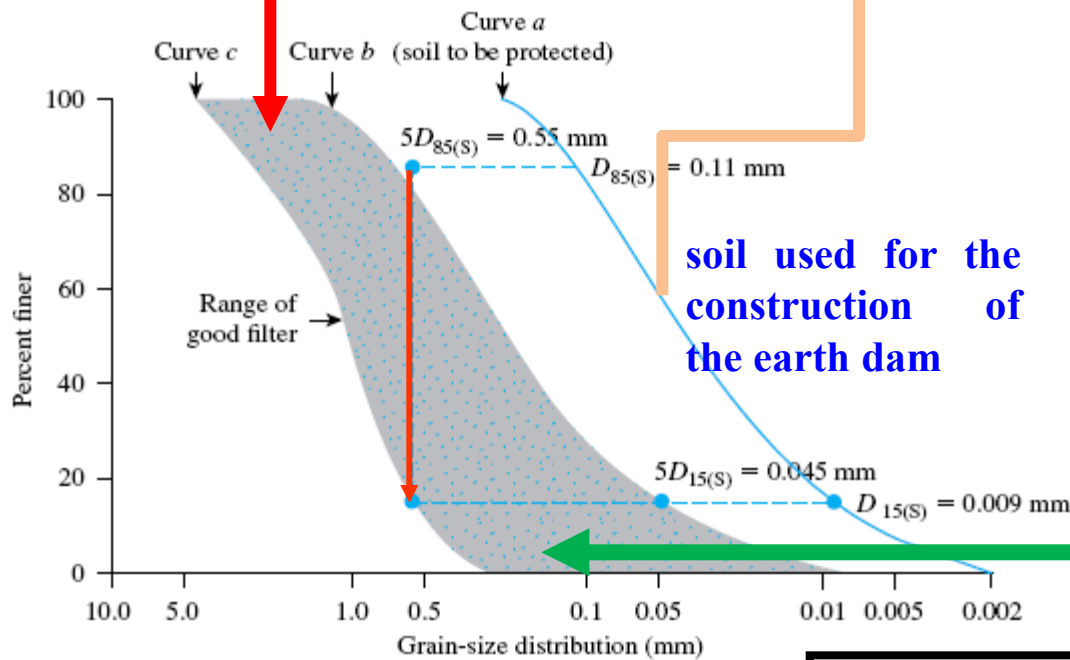
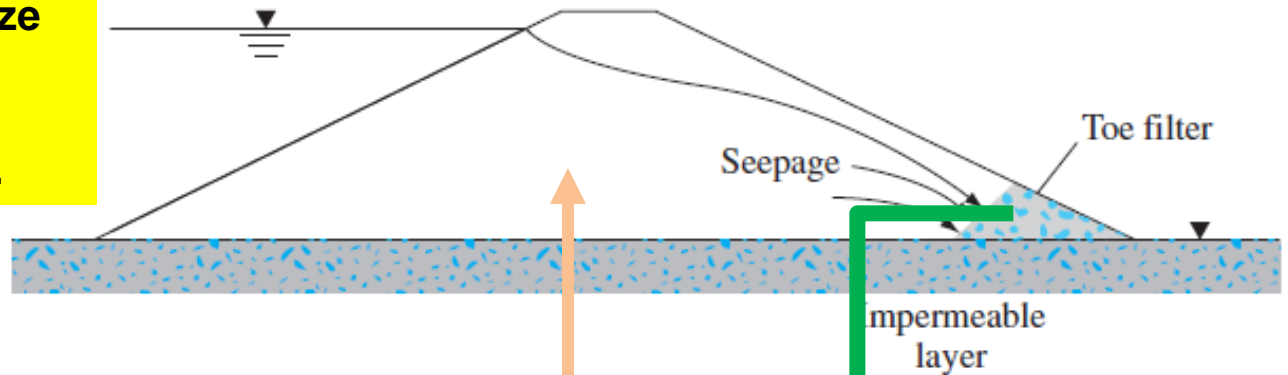

soil used for the construction of the earth dam

$$\frac{D_{15(F)}}{D_{85(S)}} \leq 4 \text{ to } 5 \quad (\text{to satisfy Condition 1})$$

$$\frac{D_{15(F)}}{D_{15(S)}} \geq 4 \text{ to } 5 \quad (\text{to satisfy Condition 2})$$

The US Navy (1948)

The following conditions are required for the design of filters:

Condition 1: For avoiding the movement of the particles of the protected soil:

$$\frac{D_{15(F)}}{D_{85(S)}} < 5$$

$$\frac{D_{50(F)}}{D_{50(S)}} < 25$$

$$\frac{D_{15(F)}}{D_{15(S)}} < 20$$

Extra

Recall Terzagh&Peck Criteria

$$\frac{D_{15(F)}}{D_{85(S)}} \leq 4 \text{ to } 5 \quad (\text{to satisfy Condition 1})$$

If the uniformity coefficient C_u of the protected soil is less than 1.5, $D_{15(F)}/D_{85(S)}$ may be increased to 6. Also, if C_u of the protected soil is greater than 4, $D_{15(F)}/D_{15(S)}$ may be increased to 40.

The US Navy (1948)

The following conditions are required for the design of filters:

Condition 2: For avoiding buildup of large seepage force in the filter:

$$\frac{D_{15(F)}}{D_{15(S)}} > 4$$

$$\frac{D_{15(F)}}{D_{15(S)}} \geq 4 \text{ to } 5 \quad (\text{to satisfy Condition 2})$$

Condition 3: The filter material should not have grain sizes greater than 76.2 mm (3 in.). (This is to avoid segregation of particles in the filter.)

Condition 4: To avoid internal movement of fines in the filter, it should have no more than 5% passing a No. 200 sieve.

The US Navy (1948)

Condition 5: When perforated pipes are used for collecting seepage water, filters also are used around the pipes to protect the fine-grained soil from being washed into the pipes. To avoid the movement of the filter material into the drain-pipe perforations, the following additional conditions should be met:

Slots



$$\frac{D_{85(F)}}{\text{slot width}} > 1.2 \text{ to } 1.4$$

Holes



$$\frac{D_{85(F)}}{\text{hole diameter}} > 1.0 \text{ to } 1.2$$

Example 8.8

Example 8.8

The grain-size distribution of a soil to be protected is shown as curve *a* in Figure 8.22. Given for the soil: $D_{15(S)} = 0.009$ mm, $D_{50(S)} = 0.05$ mm, and $D_{85(S)} = 0.11$ mm. Using Eqs. (8.38) through (8.41), determine the zone of the grain-size distribution of the filter material.

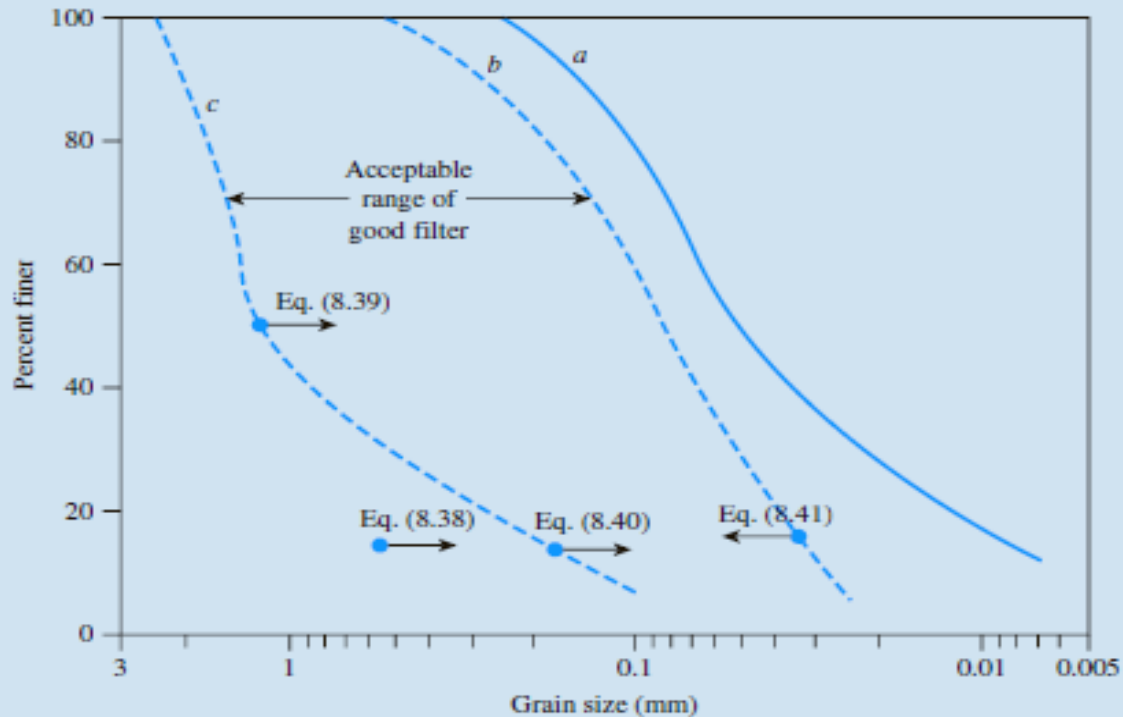

Figure 8.22

Example 8.8

Solution

From Eq. (8.38),

$$\frac{D_{15(F)}}{D_{85(S)}} < 5$$

or

$$D_{15(F)} < 5D_{85(S)} = (5)(0.11) = 0.55 \text{ mm}$$

From Eq. (8.39),

$$\frac{D_{50(F)}}{D_{50(S)}} < 25$$

or

$$D_{50(F)} < 25D_{50(S)} = (25)(0.05) = 1.25 \text{ mm}$$

From Eq. (8.40),

$$\frac{D_{15(F)}}{D_{15(S)}} < 20$$

or

$$D_{15(F)} < 20D_{15(S)} = (20)(0.009) = 0.18 \text{ mm}$$

From Eq. (8.41),

$$\frac{D_{15(F)}}{D_{85(S)}} > 4$$

or

$$D_{15(F)} > 4D_{85(S)} = (4)(0.009) = 0.036 \text{ mm}$$

The above calculations have been plotted in Figure 8.22. Curves *b* and *c* are approximately the same shape as curve *a*. **The acceptable range of good filter falls between curves *b* and *c*.**



THE END