

King Saud University

College of Engineering

IE – 462: “Industrial Information Systems”

Fall – 2023 (1<sup>st</sup> Sem. 1445H)

**Chapter 3**

***Data Modeling and Design – p2 – E-R Diagram***

Prepared by: Ahmed M. El-Sherbeeney, PhD

# Lesson Overview

- Introduction – (p1)
- **E-R Diagram** – (p2)
- Case Studies – (p3)

# Lesson Overview

- **E-R Diagram**
  - **Introduction to E-R Modeling**
    - [Introduction](#)
    - [Entities](#)
    - [Attributes](#)
    - [Candidate Keys and Identifiers](#)
    - [Other Attribute Types](#)
    - [Relationships](#)

# Lesson Overview

- **E-R Diagram**
  - **Conceptual Data Modeling and the E-R Model**
    - [Degree of a Relationship](#)
      - [Unary Relationships](#)
      - [Binary Relationships](#)
      - [Ternary Relationships](#)
    - [Cardinalities in Relationships](#)
      - [Minimum and Maximum Cardinalities](#)
      - [Alternative Cardinality System](#)
      - [Semantic Net Diagram](#)

# Lesson Overview

- **E-R Diagram**
  - **Conceptual Data Modeling and the E-R Model**
    - [Naming Relationships](#)
    - [Associative Entities](#)

# INTRODUCTION TO E-R MODELING



# Introduction



# Introduction to E-R Modeling

- Purpose of E-R modeling is to design a conceptual schema (model) of entities *and* their relationships for an organization/business
- **Entity-relationship data model** (E-R model): detailed, logical representation of:
  - **data entities**
  - **relationships**, and
  - **attributes**: they represent properties of *both* the entities and their relationships



# Introduction to E-R Modeling

## Entity-relationship diagram (ERD):

- graphical representation of an E-R model
- utilizes several notations to show data in terms of the entities and relationships described by that data
  - notation uses mostly “**crow’s foot**” symbols
  - another notation uses letters & numbers:  
“**Chen**” notation
- 1<sup>st</sup> notation places data attribute names within entity rectangles
- see next 4 slides for notations, which will be explained in detail in following sections

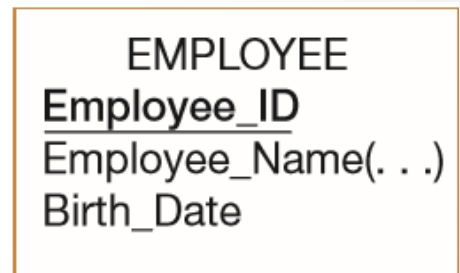
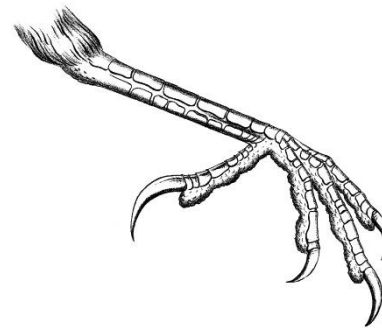

# Basic E-R Notation (Crow's Foot)

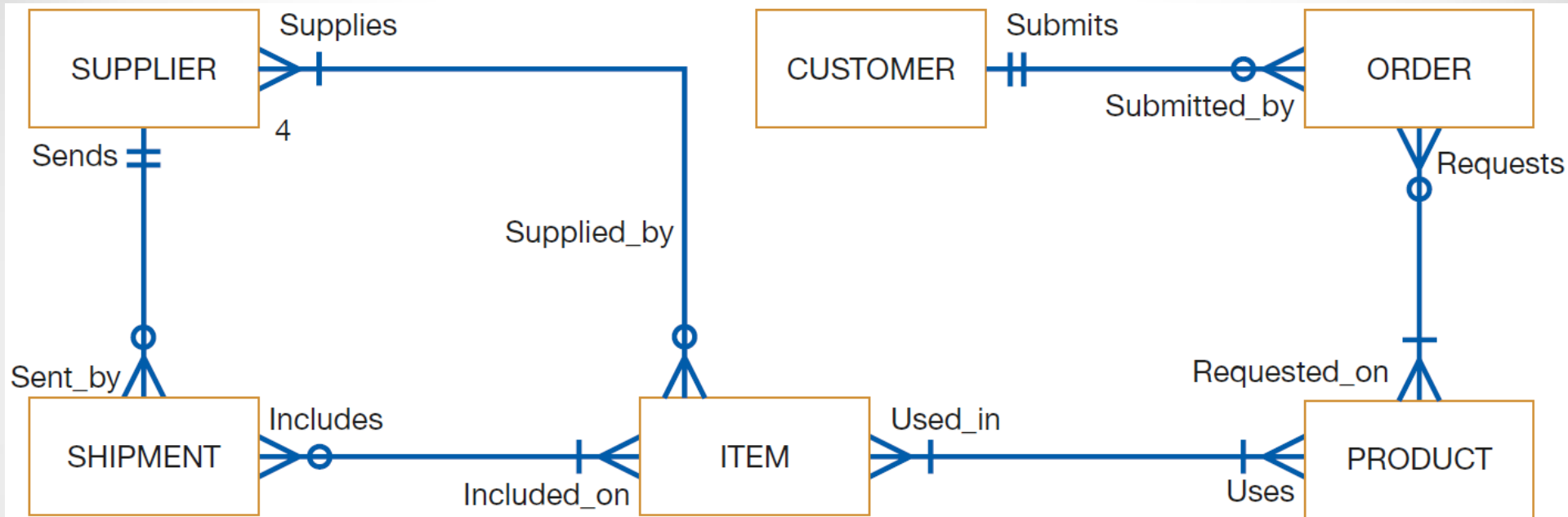

Key

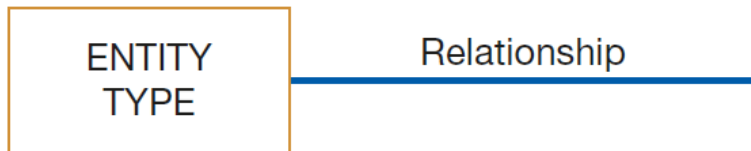

Cardinalities

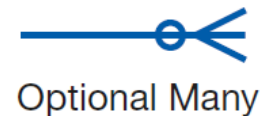
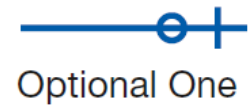
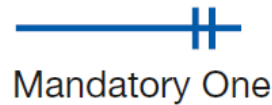

# Basic E-R Notation (Crow's Foot)

## Entity Types

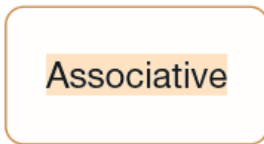
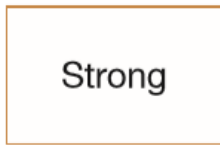

## Attributes

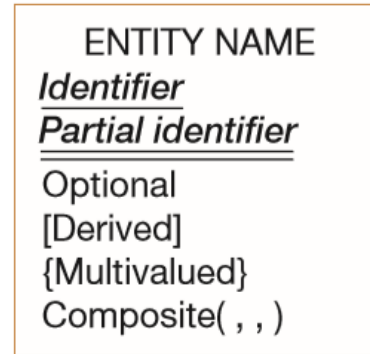

## Relationship Degrees

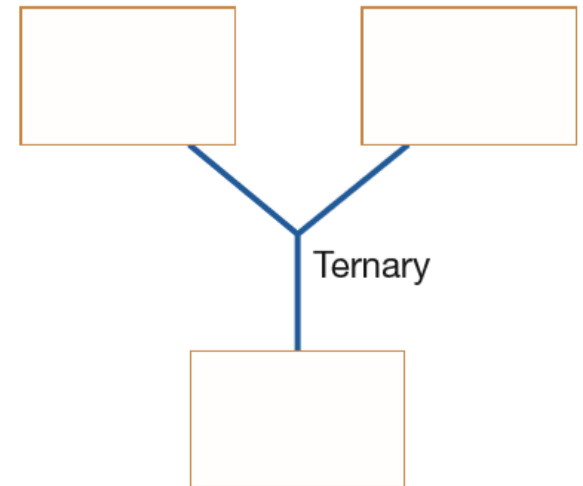

## Relationship Cardinality



Mandatory One



Mandatory Many



Optional One



Optional Many

# Basic E-R Notation (Chen)

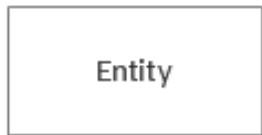

Entity

Entity



Attribute

Attribute



Weak Entity

Weak Entity



Attribute

Key attribute



Relationship

Relationship



Attribute

Weak key attribute



Relationship

Weak Entity Relationship



Attribute

Derived attribute



Associative Entity

Associative Entity



Attribute

Multivalued attribute

One-to-one Relationship



One-to-many Relationship

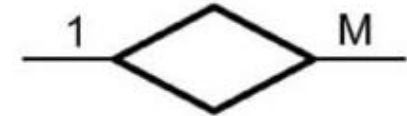

Many-to-one Relationship



Many-to-many Relationship

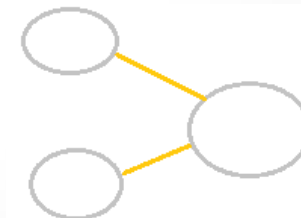

Composite Attribute

# Basic E-R Notation (Crow's Foot vs Chen)

*Chen Notation*

*Crow's Foot Notation*

**A One-to-Many (1:M) Relationship:** a PAINTER can paint many PAINTINGs; each PAINTING is painted by one PAINTER.

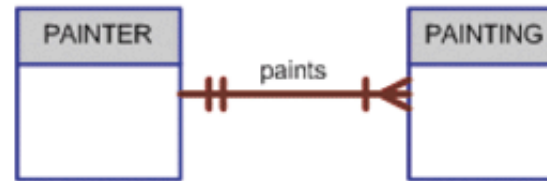

**A Many-to-Many (M:N) Relationship:** an EMPLOYEE can learn many SKILLs; each SKILL can be learned by many EMPLOYEEs.

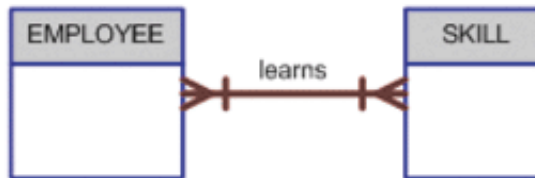

**A One-to-One (1:1) Relationship:** an EMPLOYEE manages one STORE; each STORE is managed by one EMPLOYEE.



# Basic E-R Notation (Other Styles)

Crow's Foot



Chen



Min-Max/ISO



# Basic E-R Notation (Other Styles)

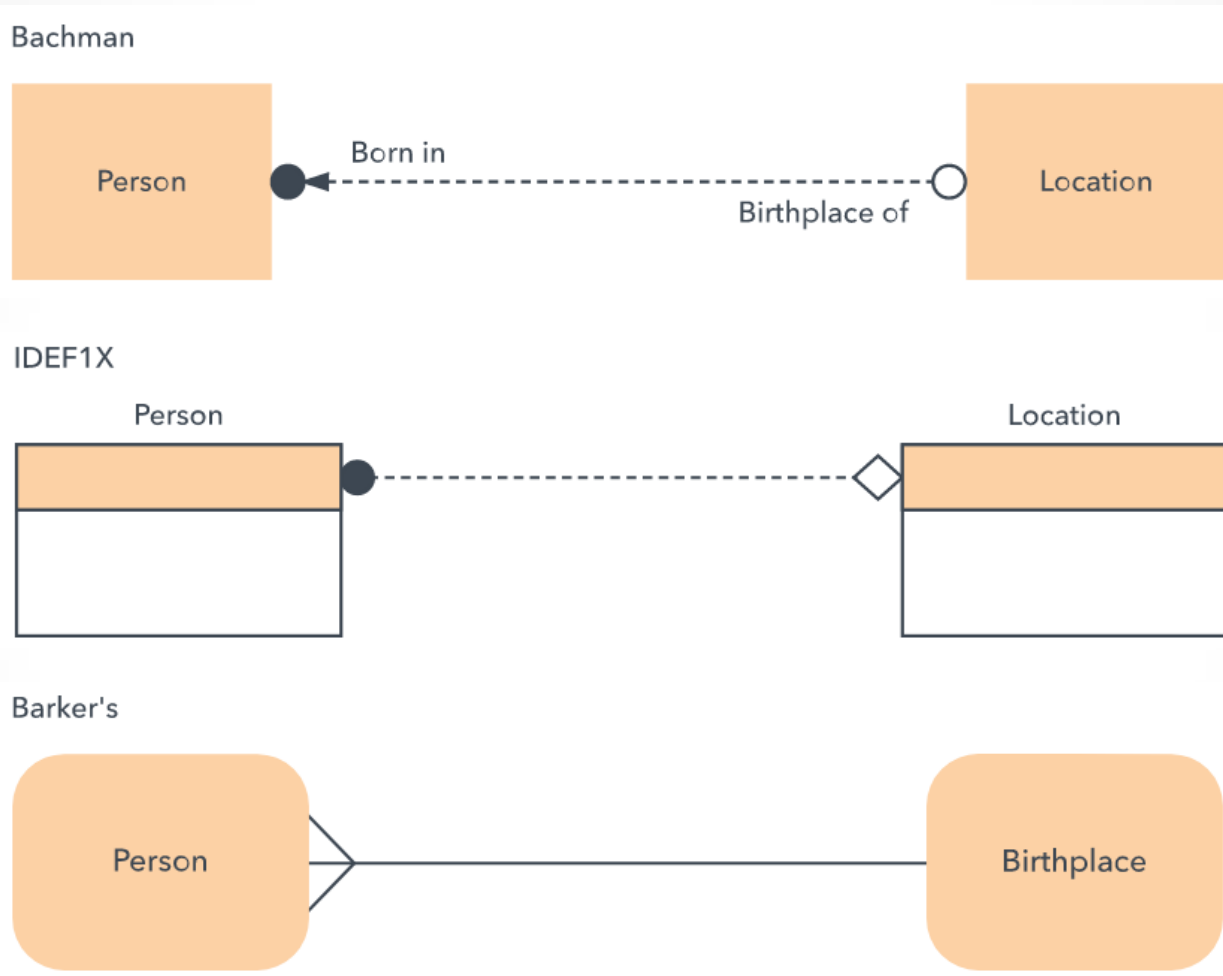

# Entities





# Entities

## Entity:

- Class of *persons, places, objects, events, or concepts* for which the organization wishes to maintain data
- Represented by Q1 in [Table 8-1](#)
- Each entity must have a *unique identity* that distinguishes it from each other entity

# Entities

## Examples of Entities (cont.):

- **Persons:** agency, contractor, customer, department, division, employee, instructor, student, supplier
- **Places:** sales region, building, room, branch office, campus, store, warehouse, state, shop floor
- **Objects:** book, machine, part, product, raw material, software license, software package, tool, vehicle model
- **Events:** application, award, cancellation, class, flight, order, registration, renewal, requisition, reservation, sale, trip, assignment
- **Concepts:** account, block of time, bond, course, fund, qualification, stock, work center

# Entities

## Entity Types vs. Entity Instances:

- Important to distinguish between *entity types* and *entity instances*
- **Entity type** (aka **entity class** or –simply– **entity**):
  - collection of entities that share common properties/characteristics
  - *each entity type* in an E-R model is given a name
  - name is placed inside a rectangle representing the entity
  - each entity is described just *once* in a data model

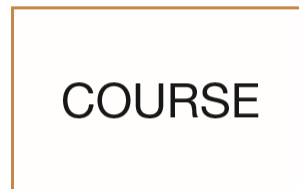

# Entities

## Entity Types vs. Entity Instances (cont.):

- **Entity instance** (aka **instance**):
  - a single occurrence of an entity
  - *many* instances of an entity type may be represented by data stored in the database

**entity**



Student ID	Last Name	First Name
2144	Arnold	Betty
3122	Taylor	John
3843	Simmons	Lisa
9844	Macy	Bill
2837	Leath	Heather
2293	Wrench	Tim

**instance**



# Entities

## Common Mistakes with Data Entities:

- Many people confuse
  - data *entities* with *sources/sinks* or system outputs,
  - *relationships* with *data flows*
- Avoid this problem with a simple rule:
  - true data entity will have *many possible instances*,
  - each instance has a distinguishing characteristic
- Example below, “sorority expense system”:
  - do we need to keep track of data about the treasurer?

TREASURER

ACCOUNT

EXPENSE

# Entities

## Naming Entity Types:

- Should use all *capital letters*
  - e.g. EMPLOYEE
- Should be named by a *singular noun*
  - e.g. CUSTOMER, STUDENT, or AUTOMOBILE
- Use *simple, concise nouns*
  - e.g. use REGISTRATION instead of STUDENT REGISTRATION FOR CLASS
- Name should be *descriptive/specific* to company
  - e.g. instead of just using ORDER, use PURCHASE ORDER  
(to distinguish between it and CUSTOMER ORDER)

# Attributes



# Attributes

## Attribute:

- A named *property* or *characteristic* of an entity that is of interest to the organization
- Represented by Q3 in [Table 8-1](#)
- Some typical entity types and associated attributes:
  - STUDENT: Student\_ID, Student\_Name, Home\_Address, Phone\_Number, Major
  - AUTOMOBILE: Vehicle\_ID, Color, Weight, Horsepower
  - EMPLOYEE: Employee\_ID, Employee\_Name, Payroll\_Address, Skill



# Attributes

## Naming Attributes:

- Use initial capital letter, followed by lowercase letters
- Use nouns for names; e.g. Age
- Use underscores to separate words (optional); e.g. Customer\_ID, Product\_Minimum\_Price
- Attribute name should be *unique*:
  - no 2 attributes of same entity type may have the same name
  - preferable no two attributes have the same name (i.e. across all entity types)
- Follow a standard format for naming attributes:
  - e.g. using Student\_GPA  
as opposed to GPA\_of\_Student

# Attributes

## Using Attributes in E-R Diagram:

- Place the name inside the rectangle for associated entity
- We use different notations to distinguish between different types of attributes (to be discussed next)

EMPLOYEE  
Employee\_ID  
Employee\_Name(. . .)  
Birth\_Date

ENTITY NAME  
Identifier  
Partial identifier  
Optional  
[Derived]  
{Multivalued}  
Composite( , , )

# Candidate Keys and Identifiers



# Candidate Keys and Identifiers

## **Candidate Key** (aka **Primary key**):

- It's an attribute (or combination of attributes) that *uniquely* identifies each instance of an entity type
- Represented by Q2 in [Table 8-1](#)
- e.g. candidate key for a STUDENT entity type might be Student\_ID

# Candidate Keys and Identifiers

## Identifiers:

- Some entities may have  $> 1$  possible candidate key; e.g. for EMPLOYEE data entity:
  - possible candidate key: Employee\_ID
  - another possible candidate key: Employee\_Name and Address (assuming no two employees with the same name live at the same address)
  - designer must choose one of the candidate keys as identifier thus:
- Identifier: candidate key that has been selected as the *unique, identifying characteristic* for entity type
  - it is represented by placing a *solid underline* below identifier

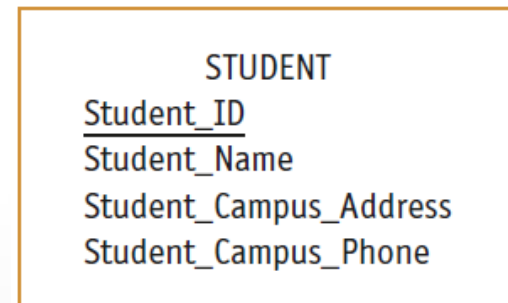

# Candidate Keys and Identifiers

## Criteria for Selecting Identifiers:

- Choose a candidate key that will *not change* its value over life of each instance of the entity type
  - e.g. don't pick identifier for EMPLOYEE: combination of Employee\_Name and Payroll\_Address
- Choose candidate key so that, for each instance of the entity, the attribute is guaranteed to have:
  - valid values and
  - not be 'null' (note, special controls in data entry can eliminate possibility of errors, e.g. use of '\*')

# Candidate Keys and Identifiers

## Criteria for Selecting Identifiers (cont.):

- Avoid so-called “intelligent identifiers”
  - e.g. first 2 digits of a key for a PART entity may indicate the warehouse location
  - note that such codes are often modified, and this would make primary key values invalid
- Example here:
  - representation for a STUDENT entity type using E-R notation
  - STUDENT has:
    - a simple identifier, Student\_ID, and
    - 3 other simple attributes

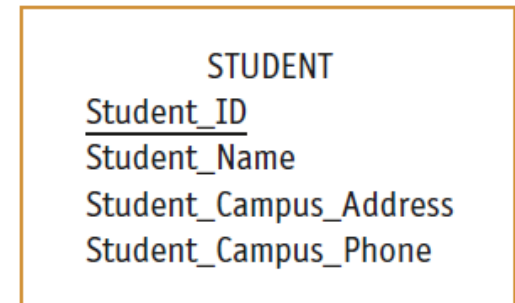

# Other Attribute Types





# Other Attribute Types

- **Single-valued attribute:**

- attribute that may take one entry in each instance of that attribute
- e.g. there is only 1 employee ID number to be entered in each instance of the attribute Employee\_ID

- **Multi-valued attribute:**

- an attribute that may take on > 1 value for each entity instance
- e.g. Skill is a multivalued attribute (since each employee can have > 1 skill)
- special symbol indicates that it is multivalued: { }

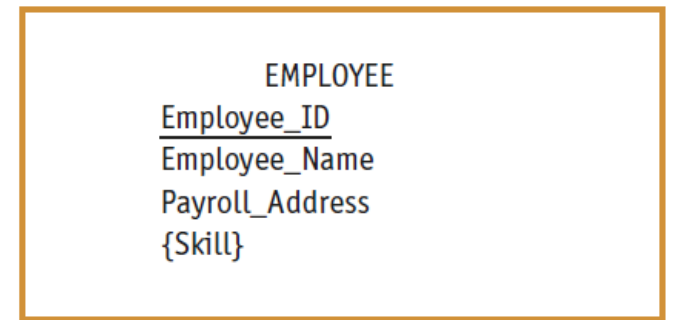

# Other Attribute Types

## Repeating group:

- A set of two or more multi-valued attributes that are logically related
- e.g. employee entity with multivalued attributes for data about each employee's dependents:
  - data includes: dependent name, age, and relation to employee
  - dependents: spouse, child, parent, etc.
  - data are multivalued attributes about employee
  - we show this by using one set of curly brackets around the data that repeats together
  - we call this a *repeating group*

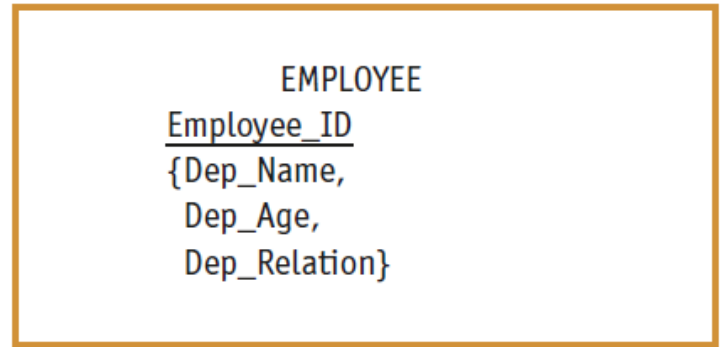

Repeating group of dependent data

# Other Attribute Types

## Weak entity:

- Second approach to representing a repeating group:
  - consider dependents as *entities*
  - we separate the repeating data into another entity, called a *weak (or attributive) entity*
  - weak entity is designated by:
    - *rectangle with a double line border* and
    - *relationship to link the weak entity to its associated regular entity (using double line)*

Weak entity for dependent data

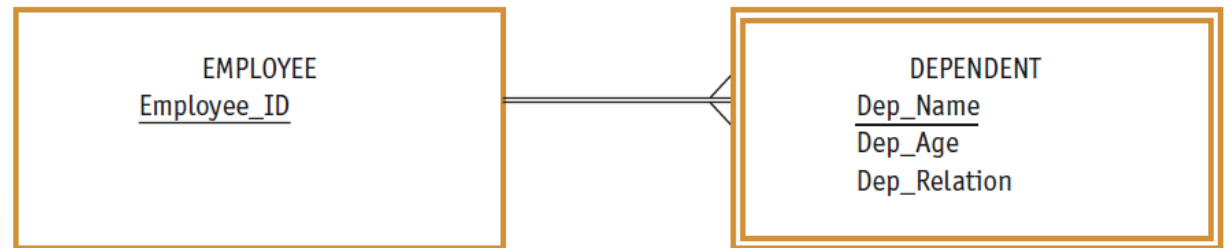

# Other Attribute Types

## Weak entity (cont.):

- Examine example below:
  - use a weak entity, DEPENDENT
  - establish relationship between DEPENDENT and EMPLOYEE
  - crow's foot next to DEPENDENT: there may be many DEPENDENTS for the same EMPLOYEE
  - identifier of DEPENDENT: dependent's name + ID of the employee, or use a double underline for Dep\_Name to designate it as a *partial identifier*

Weak entity for dependent data

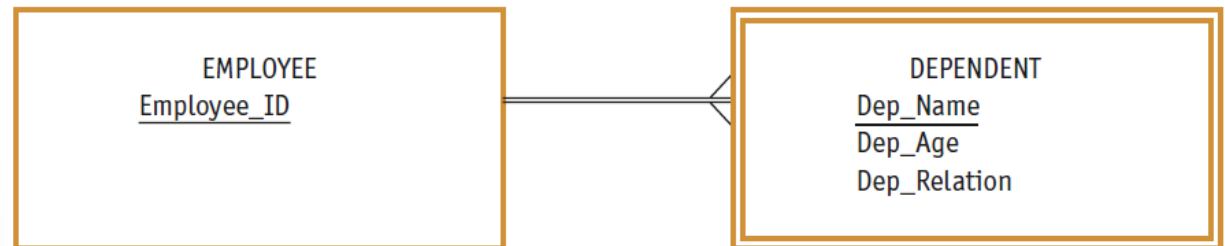

# Weak and Strong Entities (Example)

- E-R diagram uses a box to represent an entity set (PURCHASE\_ORDER, PO\_DETAIL, and VENDOR)
- E-R diagrams distinguish between *weak* and *strong* entities
  - entity is *weak* if its existence is dependent on the existence of another entity
  - e.g. of this occurs in the case of PO\_DETAIL: PO\_DETAIL is dependent on the existence of PURCHASE\_ORDER

# Weak and Strong Entities (Example) – Cont.

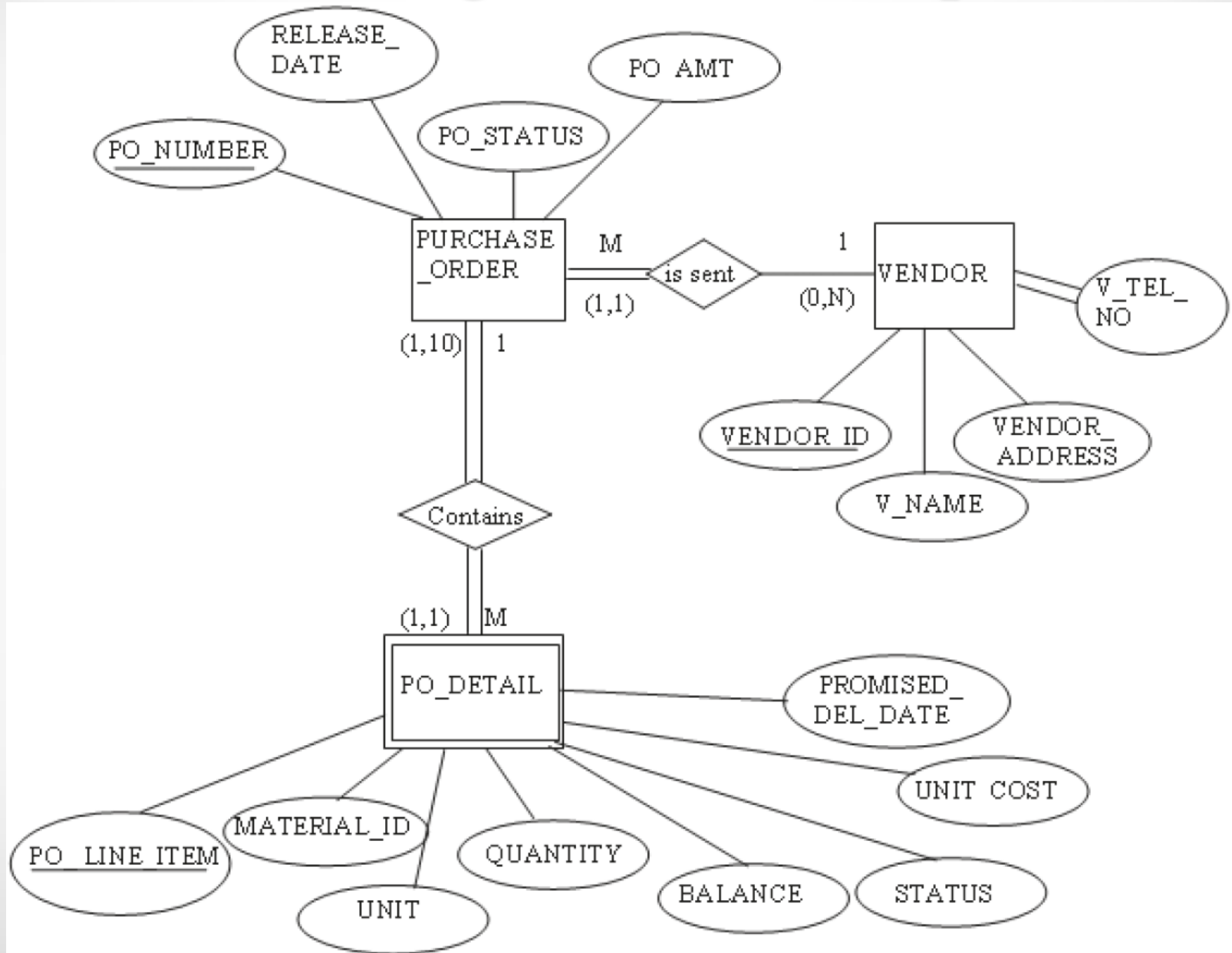

# Other Attribute Types

- **Required attribute:** an attribute that *must* have a value for every entity instance
  - shown in bold letters (list!)
- **Optional attribute:** an attribute that *may not* have a value for every entity instance
  - shown in normal letters (list!)



Required, optional, composite,  
and derived attributes

# Other Attribute Types

- **Composite attribute:** an attribute that has meaningful *component* parts
  - e.g. Name or Address
  - components are shown between brackets ( ) (list!)
- **Derived attribute:** an attribute whose value can be computed from *related attribute* values
  - shown inside square brackets: [ ] (list!)
- Notations for each attributes type is shown below

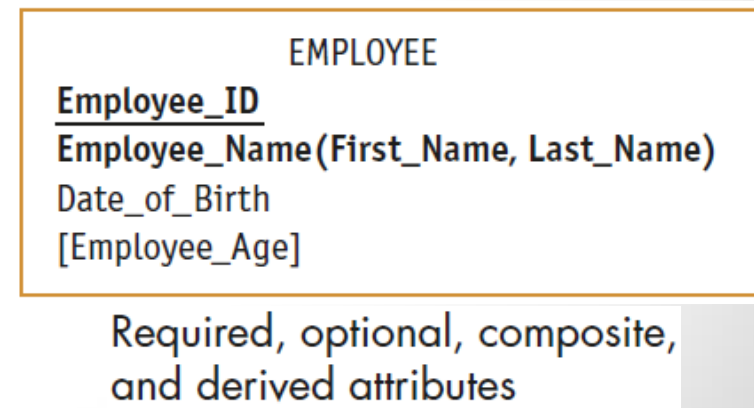
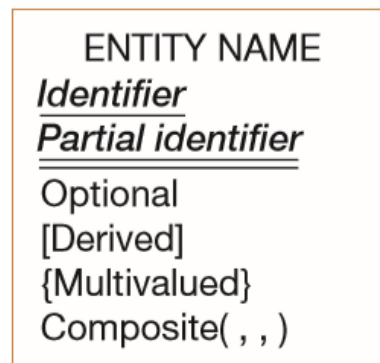



# Relationships



# Relationships

## Relationship:

ENTITY  
TYPE

Relationship

- It is association between the instances of one or more entity types that is of interest to the organization
- It is the 'glue' that holds together the various components of an E-R model
- Represented by *Questions 5, 7, and 8* in [Table 8-1](#)
- Labeled with verb phrases since usually means that an event has occurred
- Note, some standards use [two verb phrases](#) for a relationship name (so it can be read in two directions), while some only use [one verb phrase](#)

# Relationships

## Relationship (cont.):

- Consider example shown on [next slide](#):
  - training department in a company wants to track which training courses employees have completed
  - this leads to a relationship called Completes between the EMPLOYEE and COURSE entity types
  - this is a *many-to-many* relationship:
    - each *employee* may complete  $>1$  *course*
    - each *course* may be completed by  $>1$  *employee*
  - we can use Completes relationship to determine:
    - courses a given employee has completed
    - identity of each employee who has completed a particular course

Relationship type and instances  
(a) Relationship type (Completes)  
(b) Relationship instances

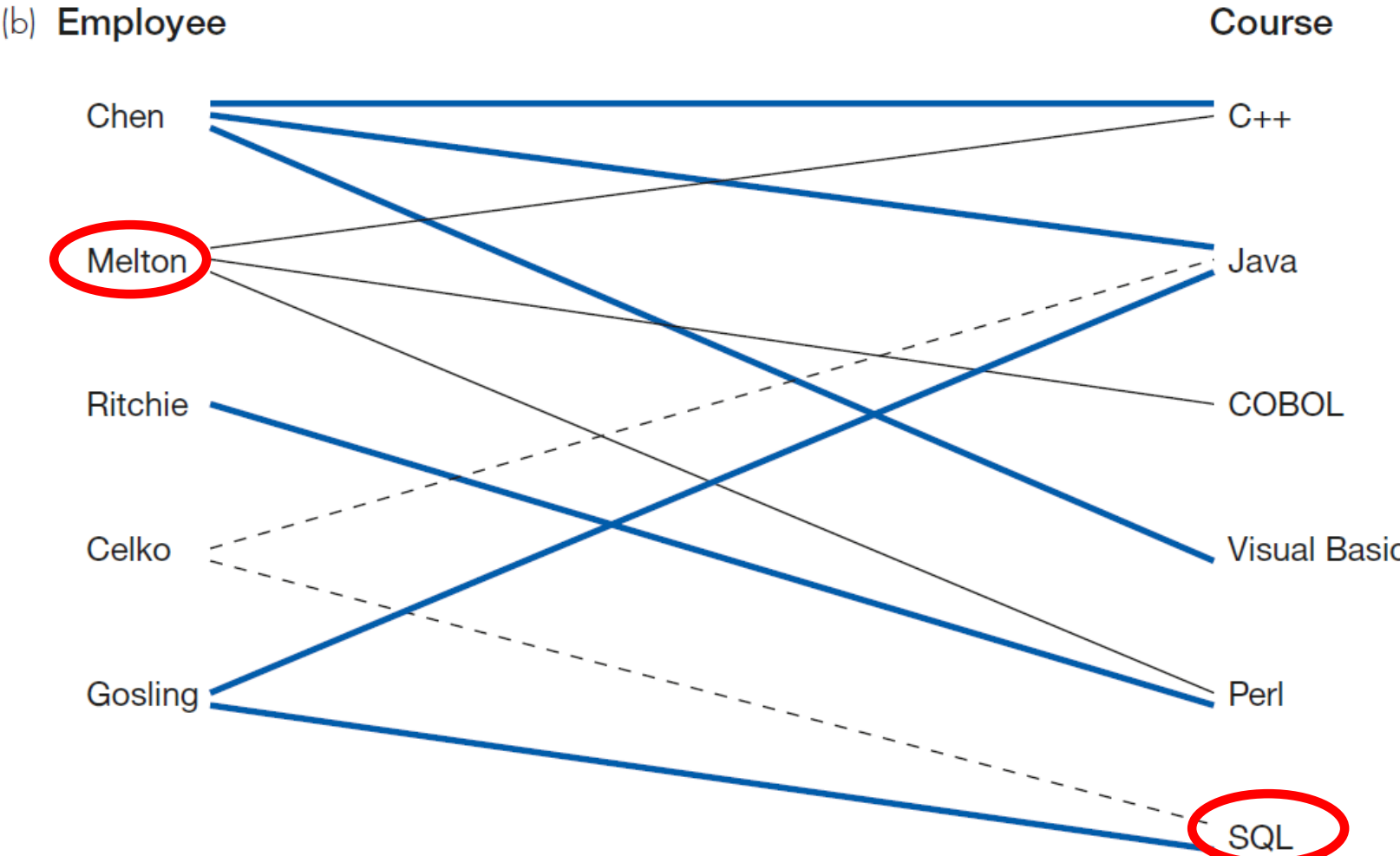
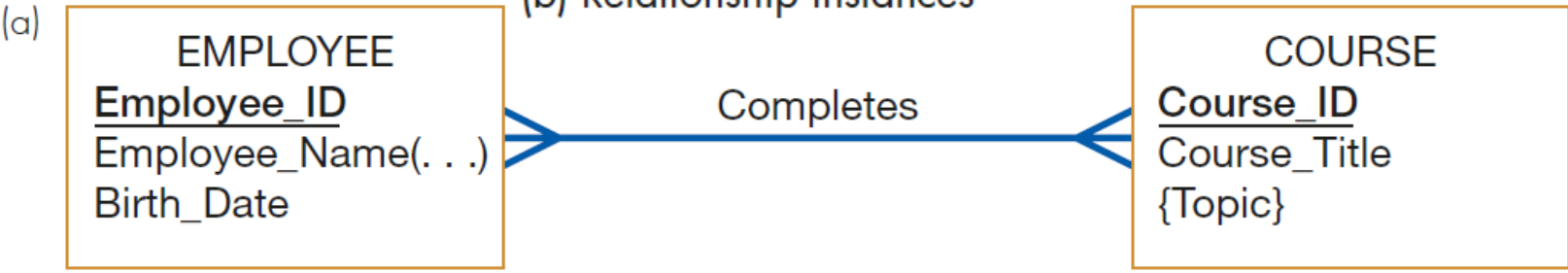

# CONCEPTUAL DATA MODELING AND THE E-R MODEL



# Degree of a Relationship



# Degree of a Relationship

- Degree of a relationship is a measure of the number of entities sharing the same association
- There are four cases:
  - **unary** relationships
  - **binary** relationships
  - **ternary** relationships
  - **n-ary** relationships

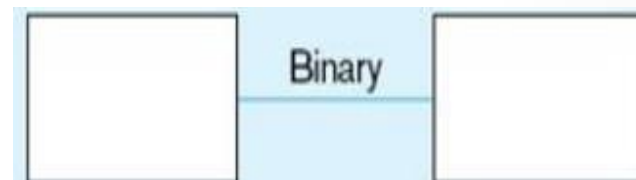
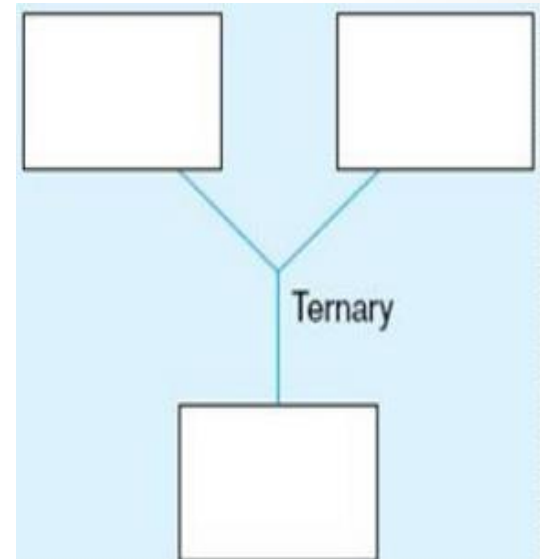

# Degree of a Relationship

## Unary Relationships

- A unary relationship is a relationship between the instances of one entity type (i.e. *within a single entity*)
  - i.e. the entity has a relationship with itself
  - aka **recursive relationship**
- Examples:
  - `Is_married_to`: *one-to-one* relationship between instances of PERSON entity
  - `Manages`: *one-to-many* relationship between instances of EMPLOYEE entity (used to identify employees who report to a particular manager and vice versa)

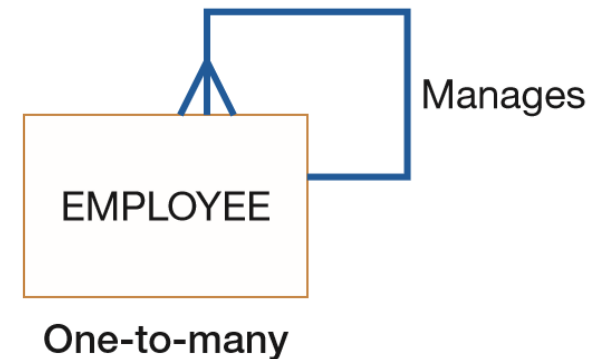
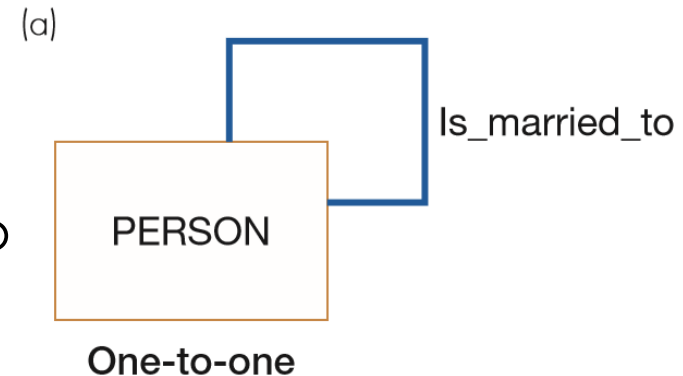

**FIGURE 8-11**

Examples of relationships of different degrees

(a) Unary relationships





# Degree of a Relationship

## Unary Relationships (cont.)

- [Next slide](#): example of another common unary relationship: **bill-of-materials structure**
  - Many manufactured products are made of subassemblies
  - Subassemblies in turn are composed of other subassemblies and parts, and so on
  - Figure 8-12a: shows this as *many-to-many unary* relationship
    - relationship name: Has\_components
    - attribute Quantity: property of the relationship; indicates # of each component that is contained in a given assembly
  - Figure 8-12b: 2 occurrences of this structure
    - easy to see associations are in fact many-to-many
    - e.g. TX100 consists of items BR450 (Qty 2) & DX500 (Qty 1)
    - also, some components are used in several higher-level assemblies (e.g. WX240 used in item MX300 & WX340)

# Degree of a Relationship

## Unary Relationships (cont.)

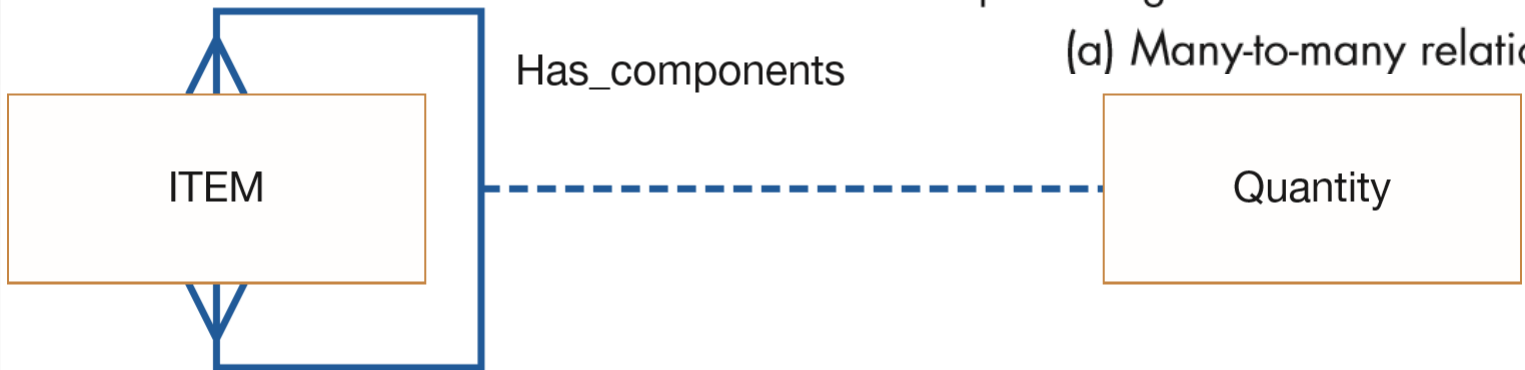
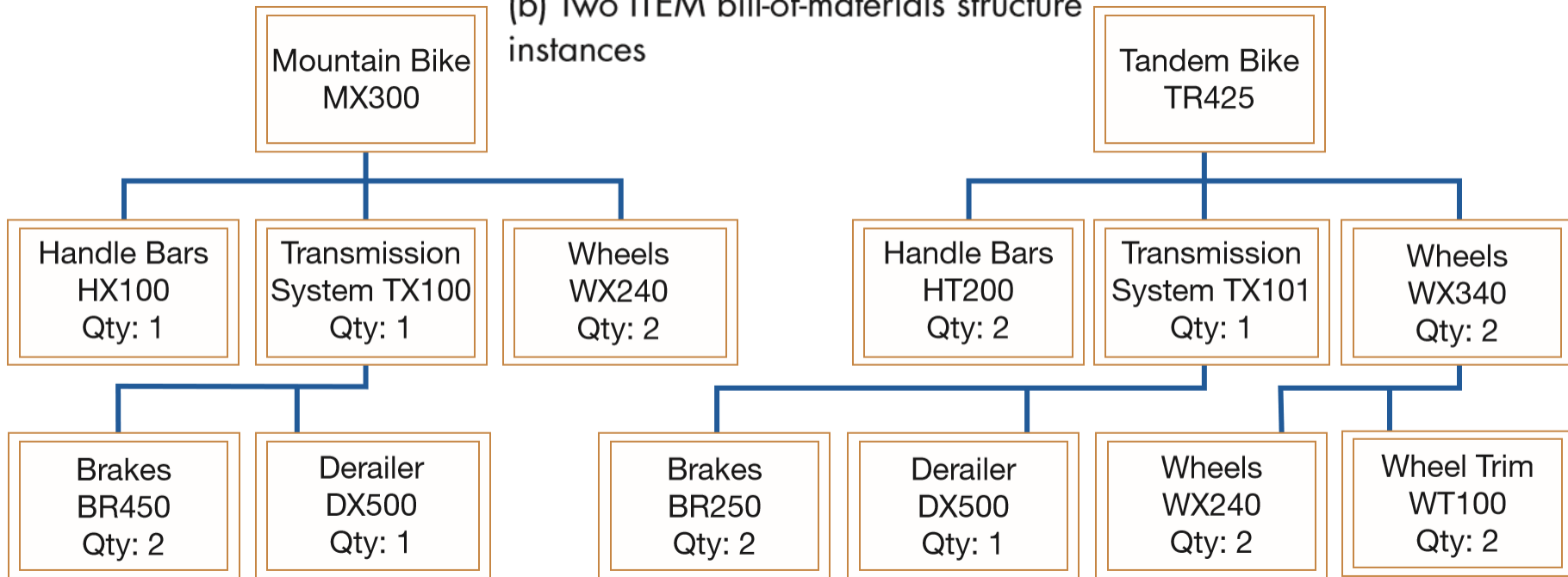

**FIGURE 8-12**

Representing a bill-of-materials structure

(a) Many-to-many relationship

(b) Two ITEM bill-of-materials structure instances



# Degree of a Relationship

## Binary Relationships

- Binary relationship:
  - Exists when two entities have an *associated relationship* (i.e. relationship between instances of two entities)
  - It is the most common relationship used in data modeling
- Three example are shown on the [next slide](#)



# Degree of a Relationship

## Binary Relationships (cont.)

- Examples (cont.)
  - *one-to-one*: employee is assigned 1 parking place, each parking place is assigned to 1 employee
  - *one-to-many*: product line may contain several products, and each product belongs to only 1 product line
  - *many-to-many*: student may register for > 1 course, each course may have many student registrants

**FIGURE 8-11**

Examples of relationships of different degrees

### (b) Binary relationships

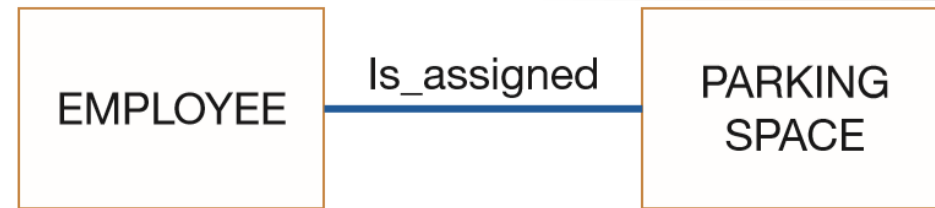

One-to-one

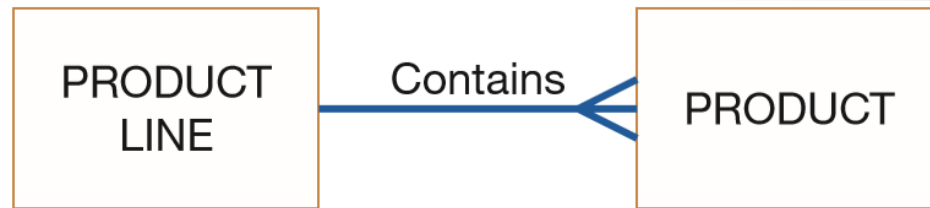

One-to-many



Many-to-many

# Degree of a Relationship

## Ternary Relationships

- Ternary relationship:
  - It is *simultaneous* relationship among instances of 3 entities
  - i.e. it occurs when 3 entities share a *common relationship*
- Examine example shown on the [next slide](#):
  - Relationship: Supplies tracks the
    - quantity of a given part,
    - that is shipped by a particular vendor,
    - to a selected warehouse
  - All three entities are *many* participants (in this example)
  - Shipping\_Mode
    - attribute of Supplies relationship
    - it's type of shipping carrier used for a particular PART, shipped from particular VENDOR to particular WAREHOUSE



# Degree of a Relationship

## Ternary Relationships (cont.)

**FIGURE 8-11**

Examples of relationships of different degrees

(c) Ternary relationship

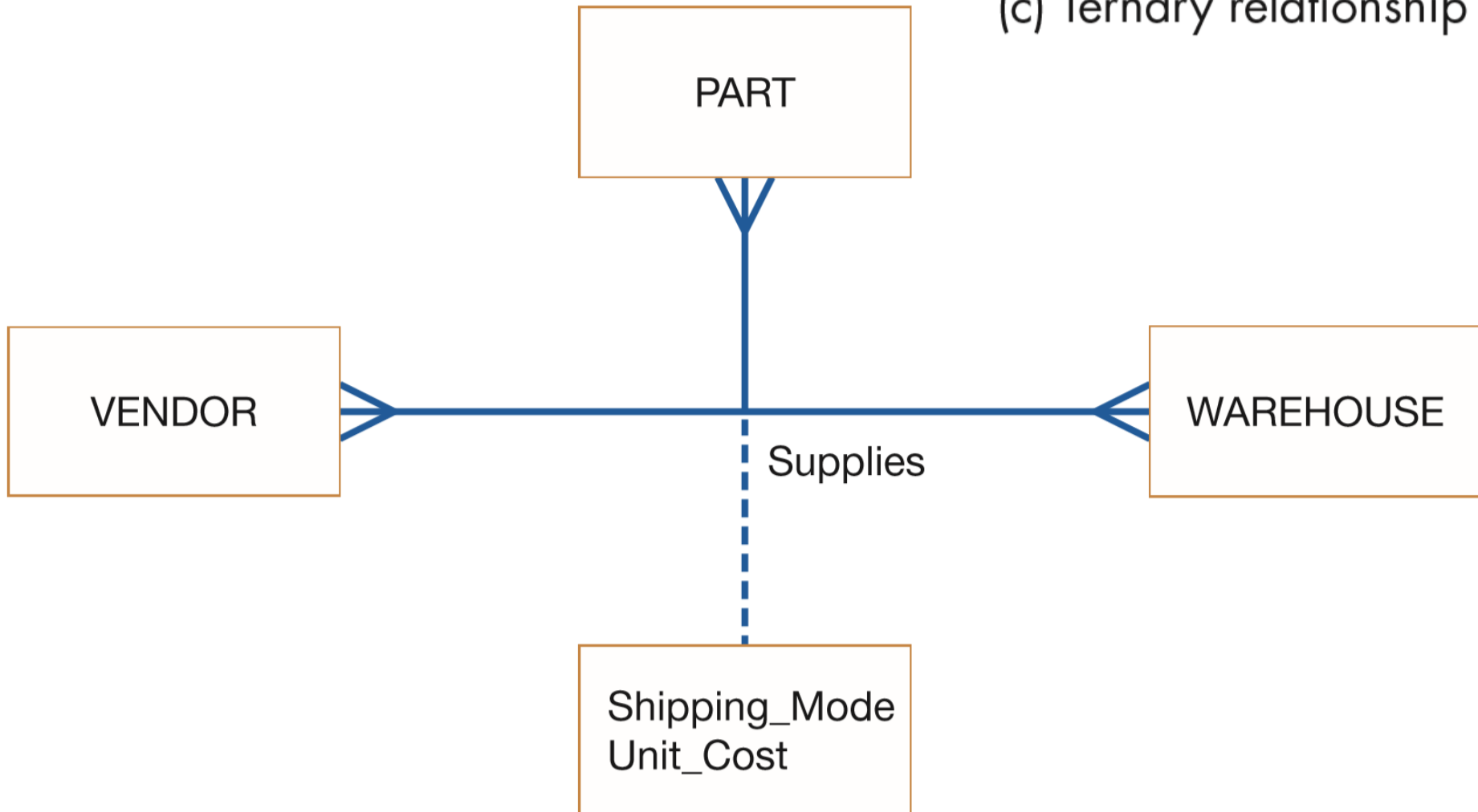

# Degree of a Relationship

## N-ary Relationships

- Occurs when  $> 3$  entities share a relationship
- This situation rarely occurs and can be ignored for the purposes of this course

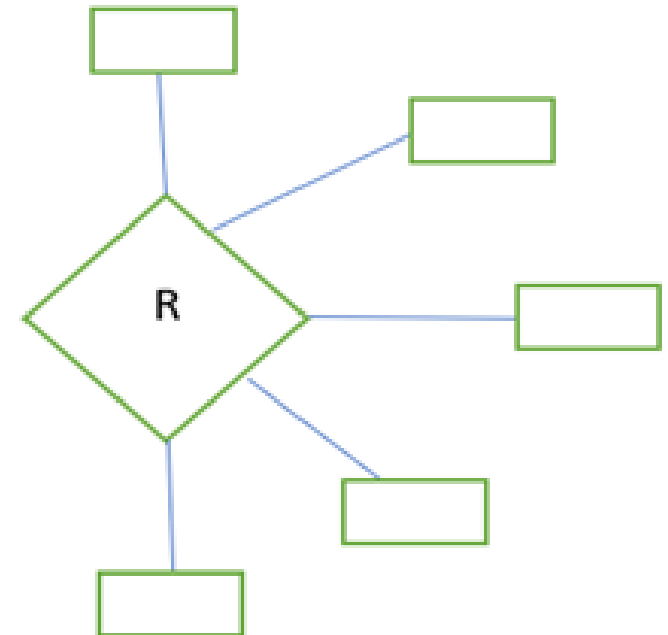
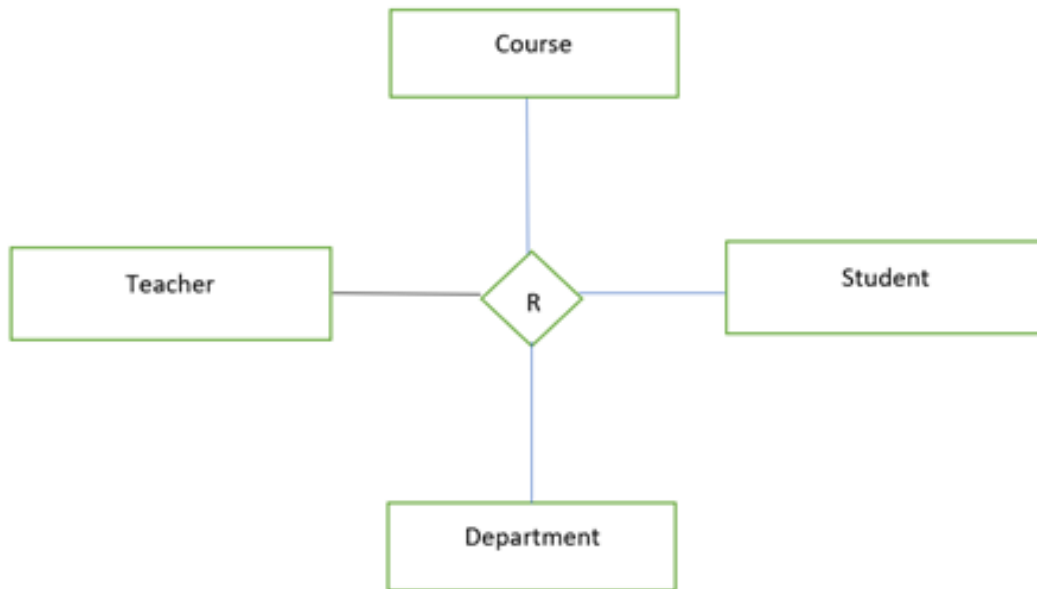

# Cardinalities in Relationships





# Cardinalities in Relationships

## Cardinality

- This is the number of entity occurrences associated with 1 occurrence of the related entity
- Represented by Questions 5, 7, and 8 in [Table 8-1](#)
- Cardinality is indicated at the ends of the relationship arc by either
  - [Symbols](#) (crow's foot notation), or
  - [Letters and numbers](#) (Chen's notation)
- Example:
  - 2 entity types, A and B, are connected by a relationship
  - $\Rightarrow$  cardinality is number of instances of entity B that can (or must) be associated with each instance of entity A

# Cardinalities in Relationships

## Minimum and Maximum Cardinalities

- Consider relationship for [DVDs at a video store](#):
  - Since video store may stock  $> 1$  DVD of a given movie, it is clear that this is (basically) a “many” relationship (Fig. 8-13a)
- We use min. & max. cardinalities to more precisely indicate range of cardinalities for a relationship
  - This notation is shown below
  - A more detailed version is shown on the [following slide](#)



Mandatory One



Optional One



Mandatory Many



Optional Many

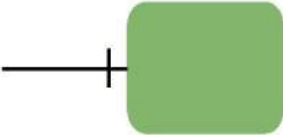
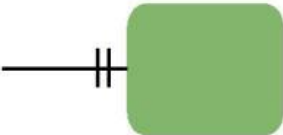
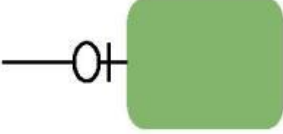
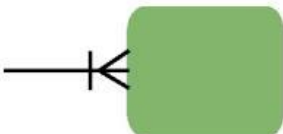
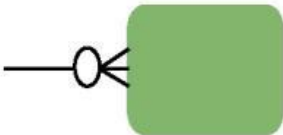
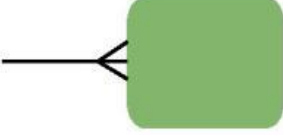

CARDINALITY INTERPRETATION	MINIMUM INSTANCES	MAXIMUM INSTANCES	GRAPHIC NOTATION
Exactly one (one and only one)	1	1	 — or — 
Zero or one	0	1	
One or more	1	many (>1)	
Zero, one, or more	0	many (>1)	
More than one	>1	>1	

# Cardinalities in Relationships

## Minimum and Maximum Cardinalities (cont.)

- Minimum Cardinality:
  - This's the *minimum number* of instances of entity B that may be associated with each instance of entity A
  - In our [e.g.](#) min. # of DVDs available for a movie is 0  
⇒ DVD is **optional participant** in the `Is_stocked_as` relationship
  - If minimum cardinality of a relationship = 1  
⇒ entity B is a **mandatory participant** in the relationship

# Cardinalities in Relationships

**FIGURE 8-13**

Introducing cardinality constraints

(a) Basic relationship

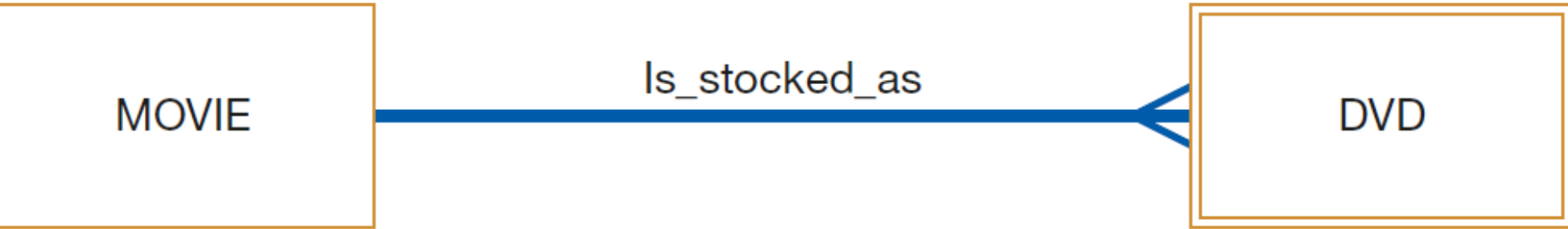

(b) Relationship with cardinality constraints

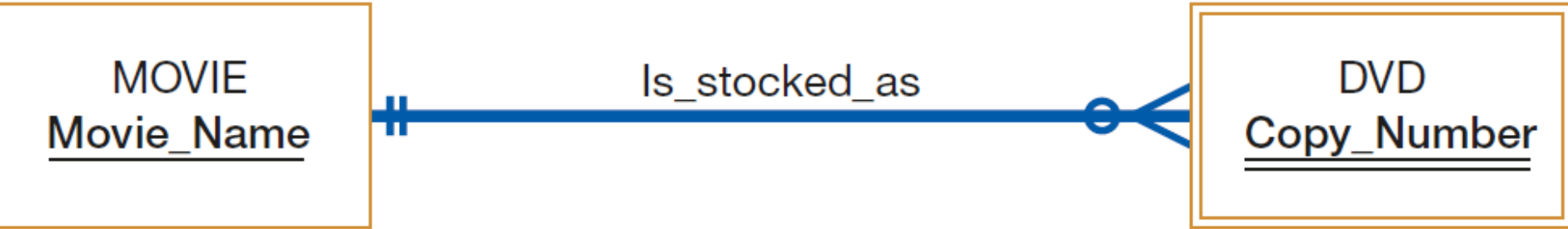

# Cardinalities in Relationships

## Minimum and Maximum Cardinalities (cont.)

- Maximum Cardinality:
  - This's is the *maximum number* of instances of entity B that may be associated with each instance of entity A
  - In our e.g. maximum is “many” (an unspecified number > 1)
  - 0 thru line near DVD entity means min. cardinality of zero
  - crow's foot notation means a “many” maximum cardinality
  - double underline of Copy\_Number:
    - indicates that this attribute is part of the identifier of DVD
    - note, full composite identifier must also include the identifier of MOVIE, Movie\_Name

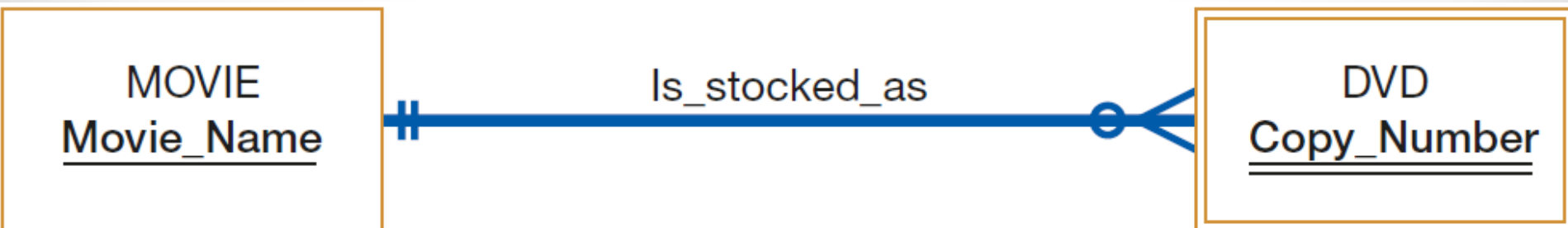

# Cardinalities in Relationships

## Minimum and Maximum Cardinalities (cont.)

- Following are 3 relationships that show *all possible combinations* of min. & max. cardinalities
- 1. PATIENT Has\_recorded PATIENT\_HISTORY
  - Each patient has recorded *one or more patient* histories (note, 1<sup>st</sup> patient visit is recorded as PATIENT HISTORY instance)
  - Each instance of PATIENT HISTORY is a record for *exactly one* PATIENT

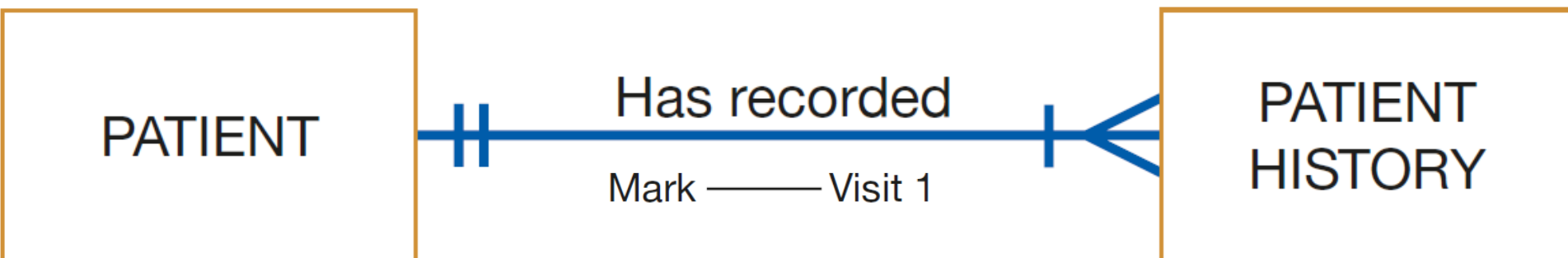

**FIGURE 8-14**

Examples of cardinality constraints  
(a) Mandatory cardinalities

# Cardinalities in Relationships

## Minimum and Maximum Cardinalities (cont.)

### 2. EMPLOYEE Is\_assigned\_to PROJECT

- Each PROJECT has *at least one* assigned EMPLOYEE
- Each EMPLOYEE *may or may not* be assigned to any existing PROJECT, or may be assigned to several PROJECTs

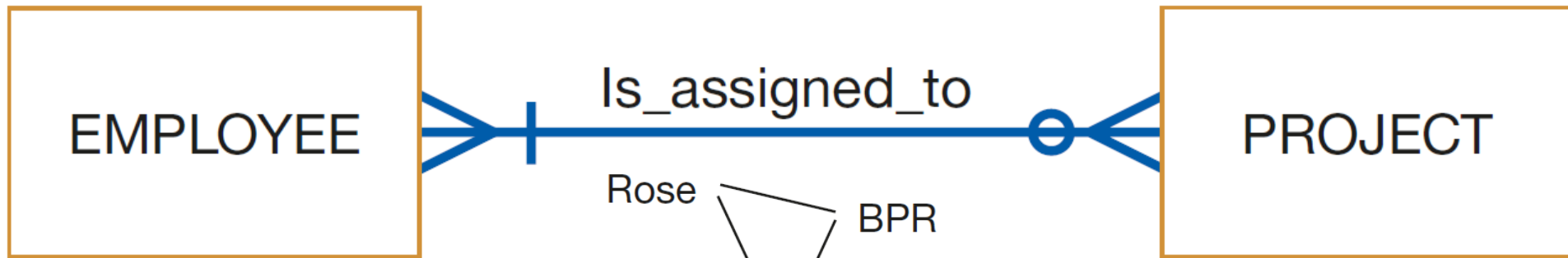

- *Relationship?*
- *Basic Relationship?*
- *Degree of Relationship?*
- *Cardinality Limits?*
- *Cardinality Constraints?*

**FIGURE 8-14**

Examples of cardinality constraints  
(b) One optional, one mandatory cardinality



# Cardinalities in Relationships

## Minimum and Maximum Cardinalities (cont.)

### 3. PERSON Is\_married\_to PERSON

- This is an optional zero or one cardinality (in both directions)
- i.e. person may or may not be married

**FIGURE 8-14**

Examples of cardinality constraints  
(c) Optional cardinalities

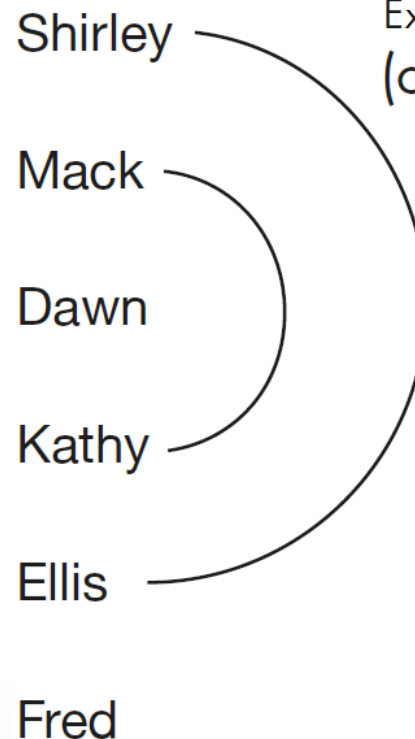
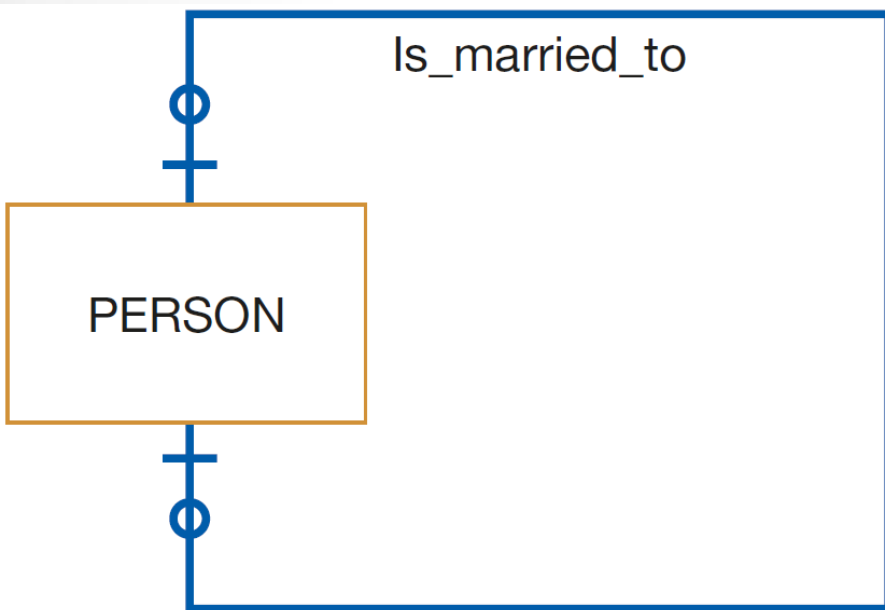

- *Relationship?*
- *Basic Relationship?*
- *Degree of Relationship?*
- *Cardinality Limits?*
- *Cardinality Constraints?*

# Cardinalities in Relationships

## Minimum and Maximum Cardinalities (cont.)

- It is possible for the maximum cardinality to be a fixed number, not an arbitrary “many” value
  - Cardinality limits are determined according to the way in which the business is operated (**business rules** of enterprise)
- e.g. suppose corporate policy states that employee may work on *at most 5* projects at the same time
  - We could show this business rule by placing a “5” above (or below) crow’s foot next to PROJECT entity

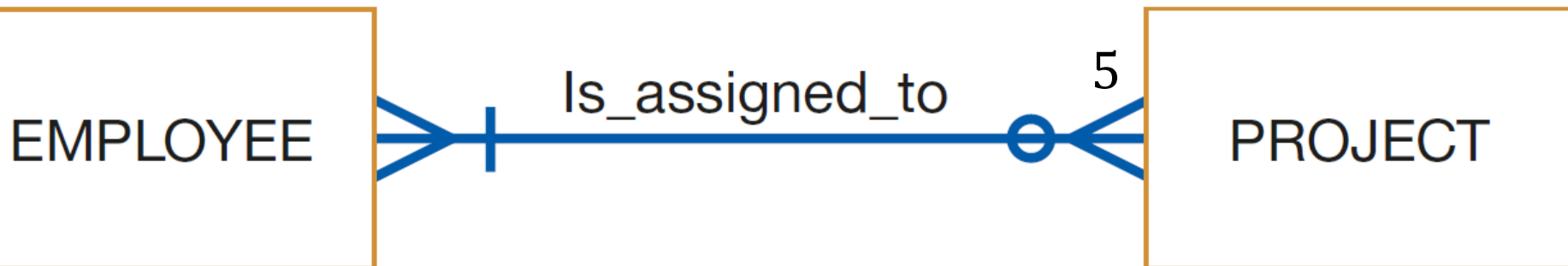

# Cardinalities in Relationships

## Alternative Cardinality System (cont.)

- Uses *letters* and *numbers* instead of Crow's foot notation (sometimes called *Chen's notation*)
- Cardinality (type of relationship) is expressed in the following way:
  - 1 : 1 (one-to-one)
  - 1 : M (one-to-many)
  - M : N (many-to-many)
- Cardinality limits are shown in parentheses (min. cardinality, max cardinality); examples:
  - (1, 1)
  - (1, 7)
  - (0, N)



# Cardinalities in Relationships

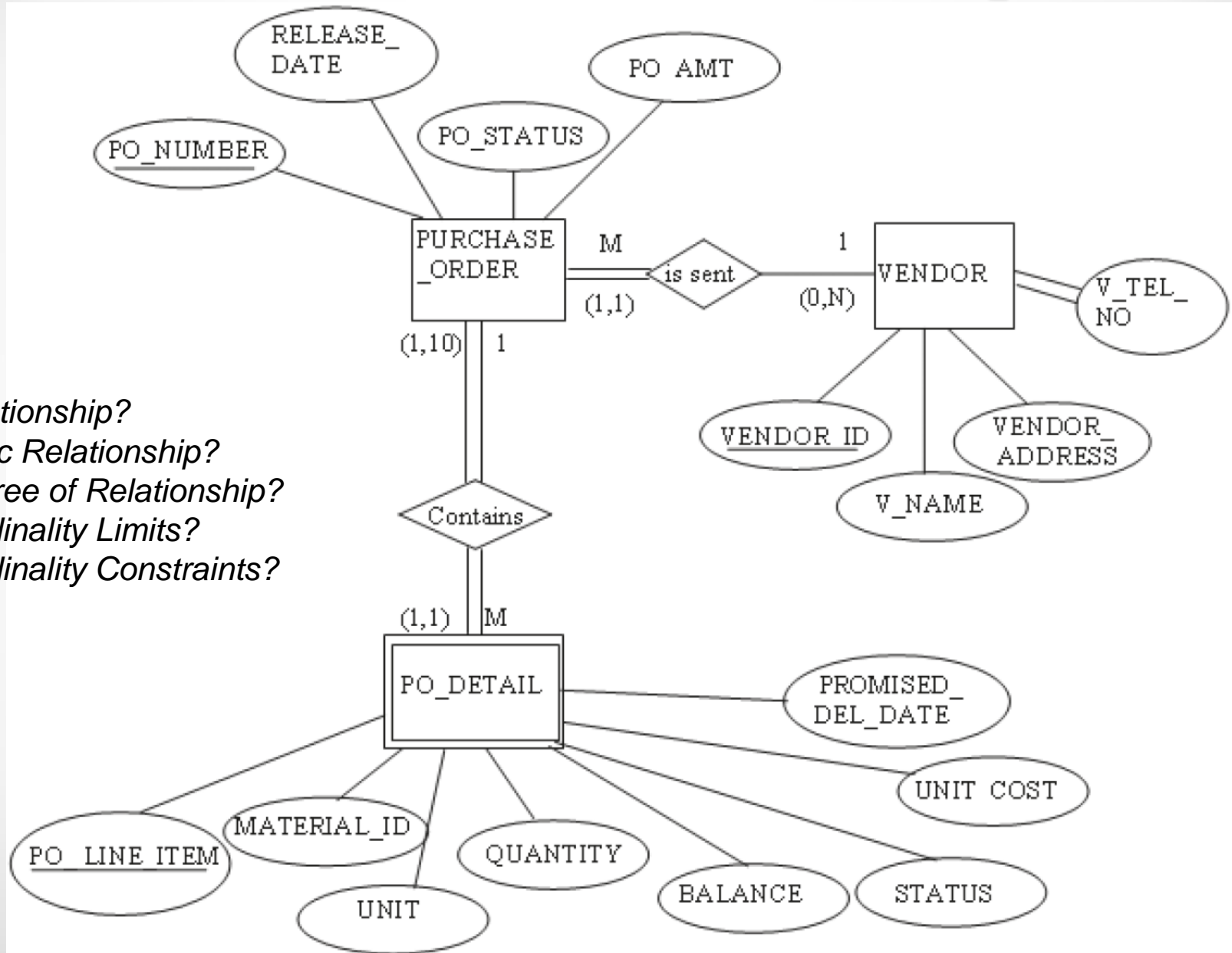

- *Relationship?*
- *Basic Relationship?*
- *Degree of Relationship?*
- *Cardinality Limits?*
- *Cardinality Constraints?*

# Cardinalities in Relationships

## Alternative Cardinality System (cont.)

- Let's see if you can determine for the e.g. below:
    - Type and degree of relationship
    - Cardinality limits for each entity
    - Relationship constraints
- *Relationship?*
  - *Basic Relationship?*
  - *Degree of Relationship?*
  - *Cardinality Limits?*
  - *Cardinality Constraints?*



# Cardinalities in Relationships

## Semantic Net Diagram

- $M : N$  relationship is difficult to handle in a database query
  - $\Rightarrow$  it is usu. expanded into a series of  $1 : M$  relationships in the final database tables
- Semantic net diagram:
  - Useful graphical tool that assists in visualizing the cardinality of a relationship
  - Can be used to represent (see upcoming slides):
    1. [1 : 1 relationship](#)
    2. [1 : M relationship](#)
    3. [M : N relationship](#)
  - Note how in [M : N relationship](#), # of instances of relationship (6) is  $>$  # of related instances in an entity set (2, 4)



# Cardinalities in Relationships

## Semantic Net Diagram (cont.)

- 1 : 1 semantic net diagram for relationship between MANAGER and DEPARTMENT

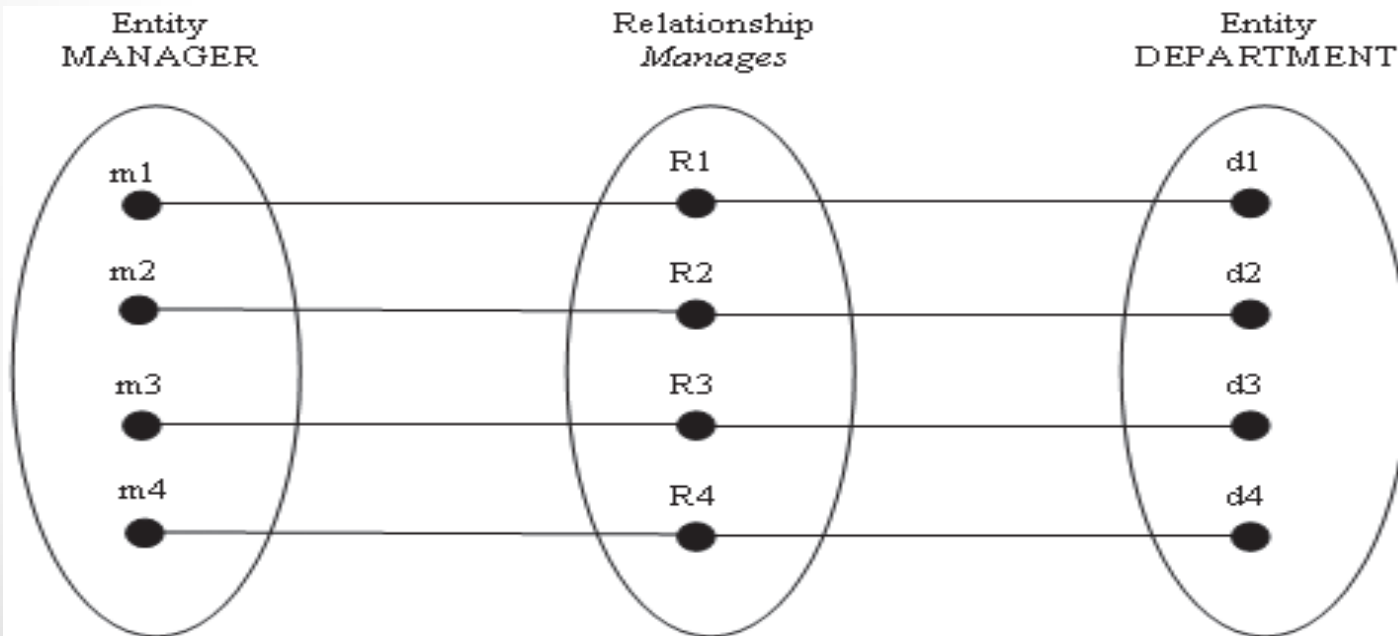
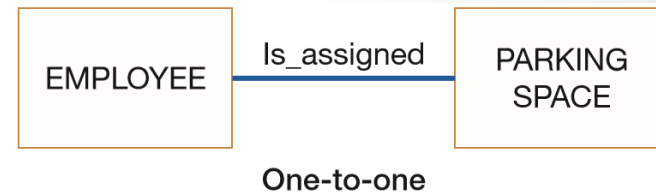

# Cardinalities in Relationships

## Semantic Net Diagram (cont.)

- 1 : M semantic net diagram for relationship between PURCHASE\_ORDER and PO\_DETAIL

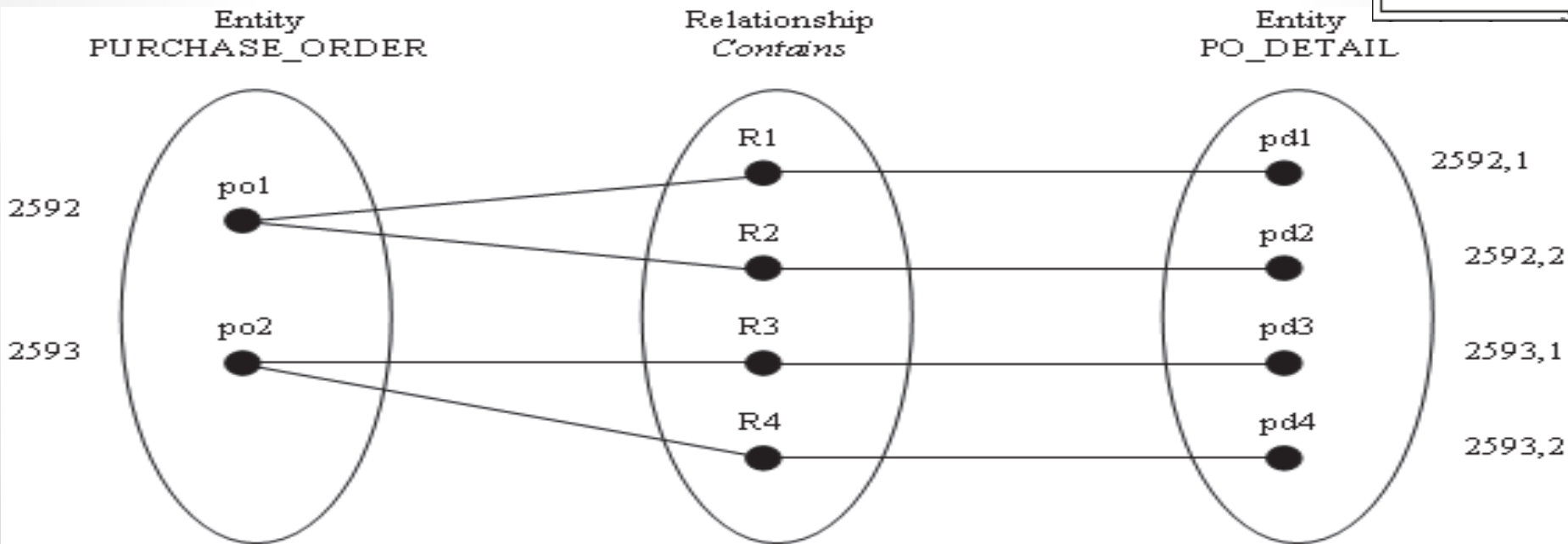
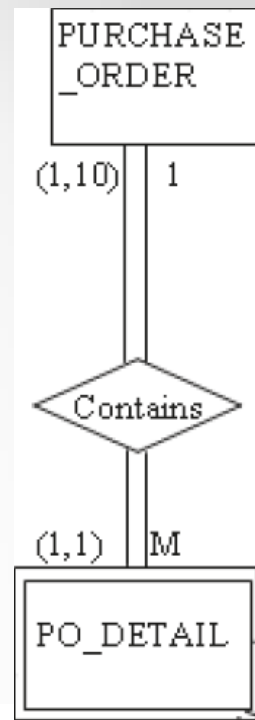



# Cardinalities in Relationships

## Semantic Net Diagram (cont.)

3. M : N semantic net diagram for relationship between VENDOR and MATERIAL
- Business rules:
    - A vendor supplies material to a company
    - 1 vendor may supply > 1 material
    - Also, specific material may be supplied by > 1 vendor

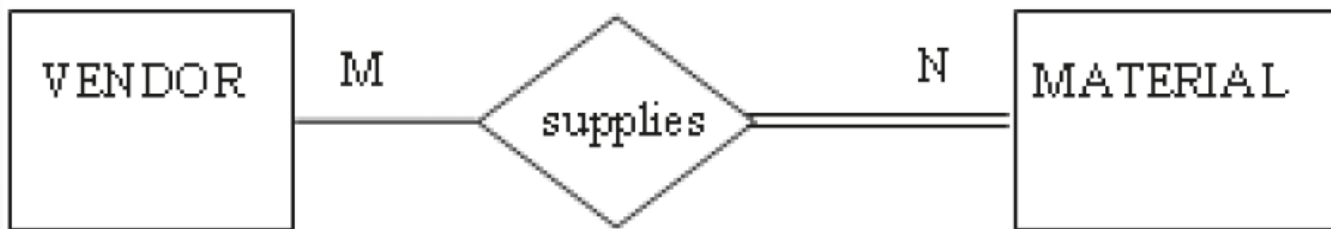

- *Relationship?*
- *Basic Relationship?*
- *Degree of Relationship?*
- *Cardinality Limits?*
- *Cardinality Constraints?*

# Cardinalities in Relationships

## Semantic Net Diagram (cont.)

- M : N semantic net diagram for relationship between VENDOR and MATERIAL (cont.):

Entity Set: VENDOR

VENDOR ID	V NAME	V STREET	V CITY	V STATE	V ZIP
V110	Jersey	2 Main St.	Patterson	NJ	07055
V25	General	125 Common	Boise	ID	44830
V250	Spices	25 Salty Lane	East Hampton	NY	10027
V75	Pasta Supply.	34 Henry St.	Philadelphia	PA	09098

Entity Set: MATERIAL

MATERIAL ID	MATL DESCRIPTION
RM201	Carrots, whole
RM202	Carrots, diced, 1/4 inch
RM205	Potatoes, Eastern,
RM210	Peas, shelled
RM211	Tomatoes, whole
RM310	Garlic, whole
RM311	Garlic powder
RM318	Salt, iodized
RM308	Onion salt
RM305	Paprika
RM340	Sugar, bulk
RM805	Olive oil
RM810	Vinegar, white

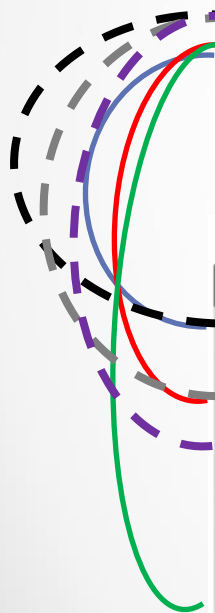

# Cardinalities in Relationships

## Semantic Net Diagram (cont.)

- M : N semantic net diagram for relationship between VENDOR and MATERIAL (cont.):

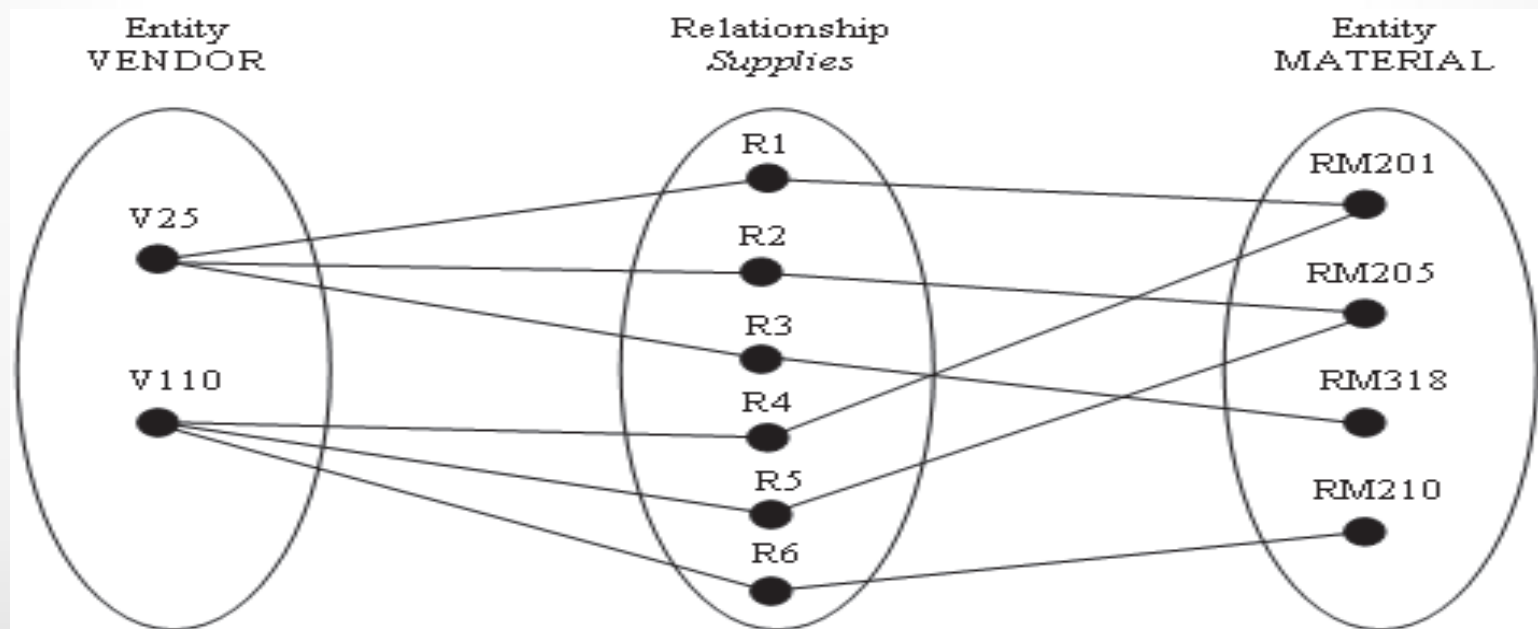
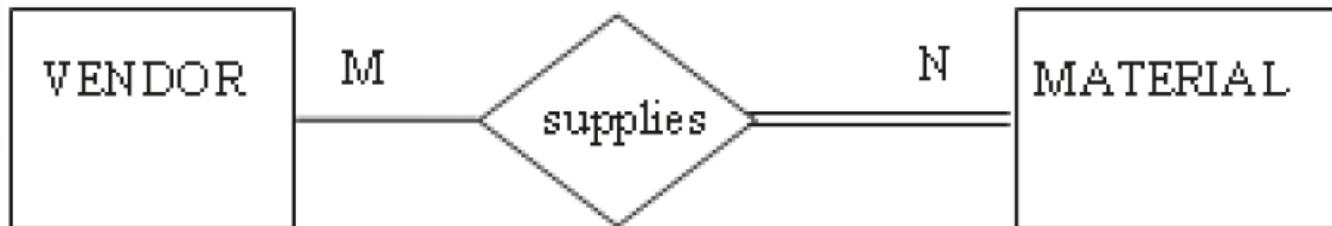

# Naming Relationships



# Naming Relationships

## **Few special guidelines for naming relationships:**

- Relationship name is a verb phrase
  - e.g. Assigned\_to, Supplies, or Teaches
- Relationships represent actions, usually in the present tense
- Relationship name states the action taken, not the result of the action
  - e.g. use Assigned\_to, not Assignment
- Avoid vague names
  - e.g. such as Has or Is\_related\_to
- Use descriptive verb phrases (action verbs)

# Associative Entities



# Associative Entities

- Also called composite/bridge entity
- Entity type that relates/associates instances of 1 or more entity types (e.g. [Has\\_components](#), [Supplies](#))
- Transforms  $M : N$  relationship into  $1 : M$  relationships
- Contains attributes specific to the relationship between those entity instances
- Two different notations below:

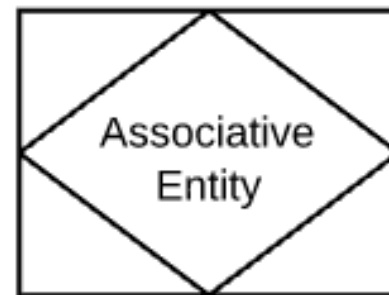
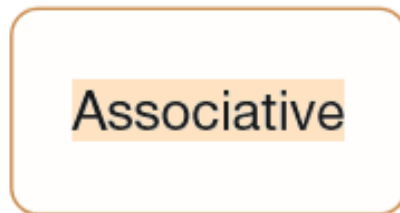

# Associative Entities

- Example 1: organization wishes to record date (month/year) that employee completes each course

<b>Employee_ID</b>	<b>Course_Name</b>	<b>Date_Completed</b>
549-23-1948	Basic Algebra	March 2017
629-16-8407	Software Quality	June 2017
816-30-0458	Software Quality	February 2017
549-23-1948	C Programming	May 2017

- Date\_Completed is *not* a property of entity EMPLOYEE
  - e.g. 549-23-1948 completed courses on different dates
- Also, Date\_Completed is *not* a property of COURSE
  - e.g. Software Quality was completed on different dates
- ⇒ Date\_Completed is a property of the *relationship* between EMPLOYEE and COURSE ([next slide](#))



# Associative Entities

**FIGURE 8-15**

An associative entity  
(a) Attribute on a relationship



(b) An associative entity (CERTIFICATE)



(c) An associative entity using Microsoft Visio®



# Associative Entities

- Example 2: Convert M : N relationship between VENDOR and MATERIAL into associative entity

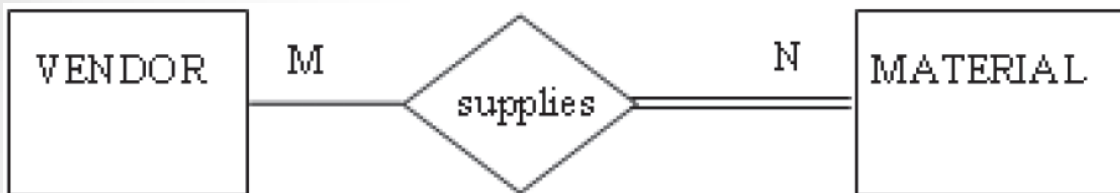

Entity Set: MATERIAL

MATERIAL ID	MATL DESCRIPTION
RM201	Carrots, whole
RM202	Carrots, diced, 1/4 inch
RM205	Potatoes, Eastern,
RM210	Peas, shelled
RM211	Tomatoes, whole
RM310	Garlic, whole
RM311	Garlic powder
RM318	Salt, iodized
RM308	Onion salt
RM305	Paprika
RM340	Sugar, bulk
RM805	Olive oil
RM810	Vinegar, white

Entity Set: VENDOR

VENDOR ID	V NAME	V STREET	V CITY	V STATE	V ZIP
V110	Jersey	2 Main St.	Patterson	NJ	07055
V25	General	125 Common	Boise	ID	44830
V250	Spices	25 Salty Lane	East Hampton	NY	10027
V75	Pasta Supply,	34 Henry St.	Philadelphia	PA	09098

# Associative Entities

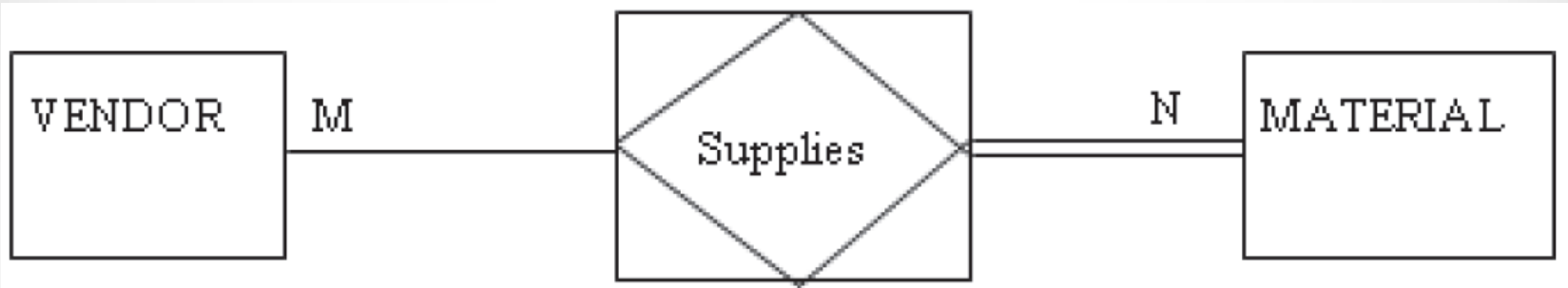

Entity Set: VENDOR\_MATL\_XREF

VENDOR ID	MATERIAL ID
V25	RM201
V25	RM205
V25	RM318
V25	RM340
V110	RM201
V110	RM202
V110	RM205
V110	RM210
V110	RM211
V250	RM310
V250	RM311
V250	RM318
V250	RM340
V250	RM308
V250	RM305
V25	RM805
V25	RM810

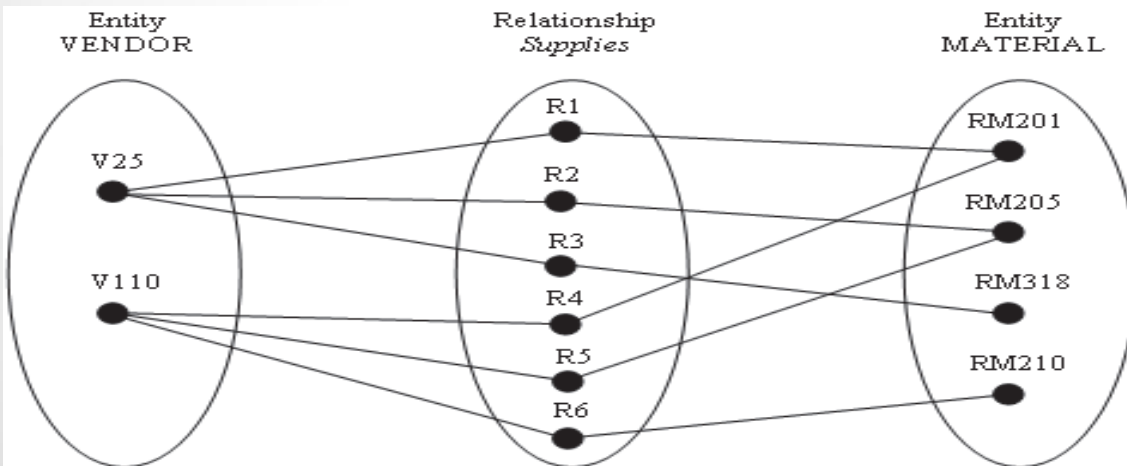

# Associative Entities

- Entity `VENDOR_MATL_XREF` is a bridge between the entities `VENDOR` and `MATERIAL`
  - i.e. associative/composite entity is used here to convert [semantic net diagram](#) for this M:N relationship into an entity
- Note the following:
  - each instance in `VENDOR` is associated with M instances of `VENDOR_MATL_XREF`, and
  - each instance of `MATERIAL` is associated with M instances of `VENDOR_MATL_XREF`
  - $\Rightarrow$  M : N relationship is converted to two 1 : M relationships
  - `VENDOR_ID/MATERIAL_ID` serves as the (composite) primary key of `VENDOR_MATL_XREF`

# Associative Entities

- Example 3: associative entity for a ternary relationship (alternative and more explicit representation of the ternary Supplies relationship shown in [Figure 8-11](#))

① Each vendor can supply many parts to any number of warehouses, but need not supply any parts.

② Each part can be supplied by any number of vendors to more than one warehouse, but each part must be supplied by at least one vendor to a warehouse.

③ Each warehouse can be supplied with any number of parts from more than one vendor, but each warehouse must be supplied with at least one part.

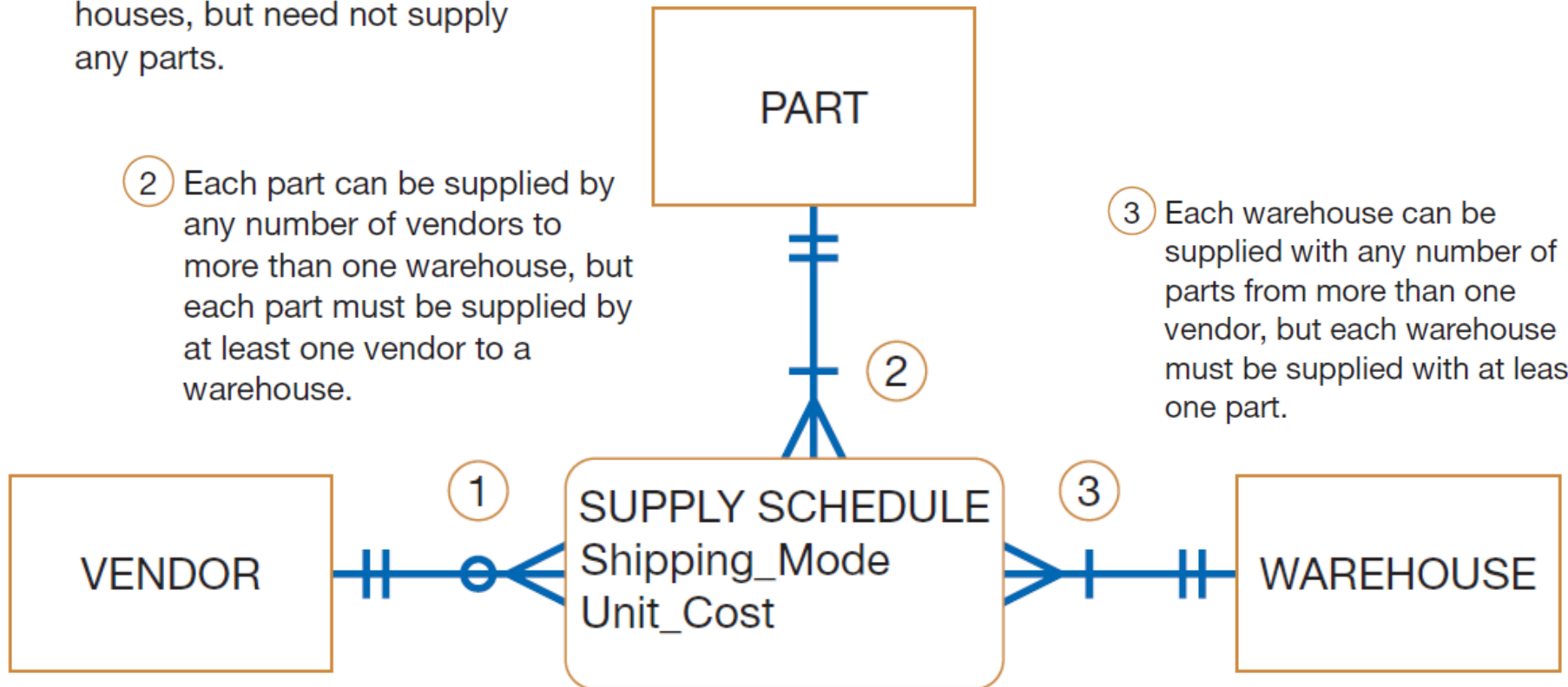

# Associative Entities

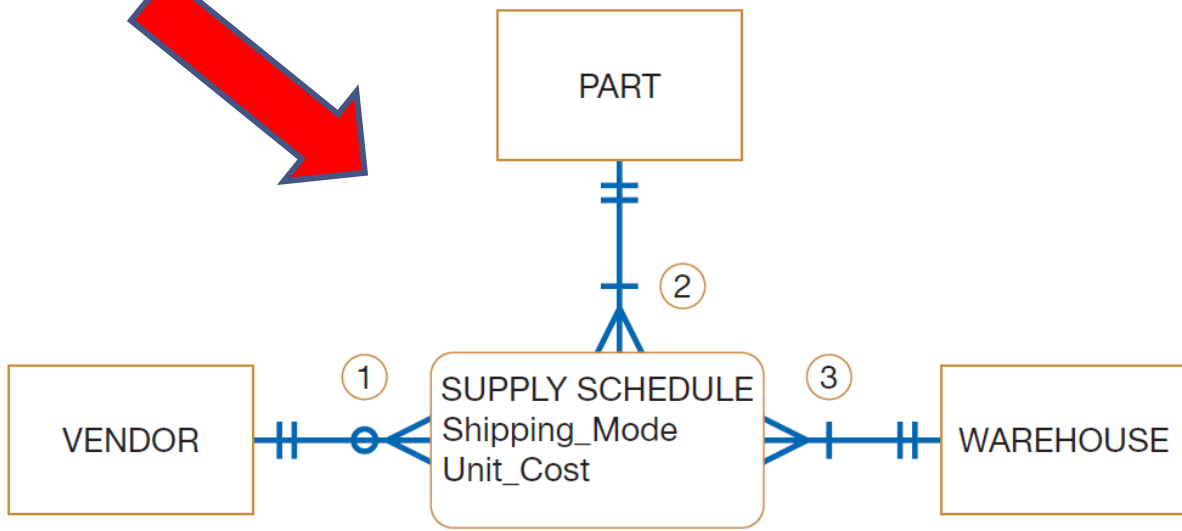
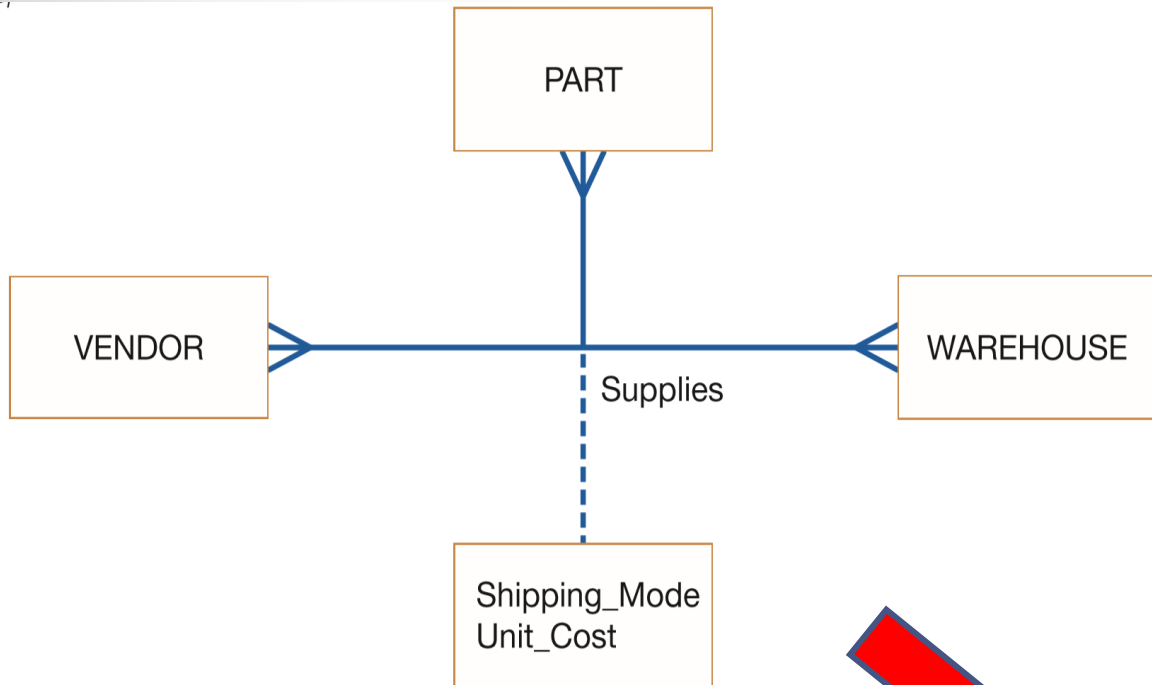

# Videos to Watch

- **Entity Relationship Diagram (ERD) Tutorial - Part 1**  
<https://youtu.be/QpdhBUYk7Kk>
- **Entity Relationship Diagram (ERD) Tutorial - Part 2**  
<https://youtu.be/-CuY5ADwn24>
- **Entity-Relationship Diagrams** (another system)  
[https://youtu.be/c0\\_9Y8QAstg](https://youtu.be/c0_9Y8QAstg)
- **Entity Relationship Diagram (ERD) Training Video**  
<https://youtu.be/-fQ-bRllhXc>

# Sources

- “**Chapter 3: Database Modeling and Design**”; Slides by Dr. Sabeur Kosantini (2017)
- “**Types of Database Management Systems**” (2017) by Arijun Panwar, c-sharpcorner.com; Available at: <https://www.c/sharpcorner.com/UploadFile/65fc13/types-of-database-management-systems/>
- **Modern Systems Analysis and Design**. Joseph S. Valacich and Joey F. George. Pearson. Eighth Ed. 2017. Chapter 8.
- **Design of Industrial Information Systems**. Thomas Boucher, and Ali Yalcin. Academic Press. First Ed. 2006. Chapter 3.



# Gathering Info. for Conceptual Data Modeling

**TABLE 8-1** Requirements Determination Questions for Data Modeling

1. *What are the subjects/objects of the business?* What types of people, places, things, materials, events, etc. are used or interact in this business, about which data must be maintained? How many instances of each object might exist? — **data entities and their descriptions**
2. *What unique characteristic (or characteristics) distinguishes each object from other objects of the same type?* Might this distinguishing feature change over time or is it permanent? Might this characteristic of an object be missing even though we know the object exists? — **primary key**
3. *What characteristics describe each object?* On what basis are objects referenced, selected, qualified, sorted, and categorized? What must we know about each object in order to run the business? — **attributes and secondary keys**
4. *How do you use these data?* That is, are you the source of the data for the organization, do you refer to the data, do you modify it, and do you destroy it? Who is not permitted to use these data? Who is responsible for establishing legitimate values for these data? — **security controls and understanding who really knows the meaning of data**

# Gathering Info. for Conceptual Data Modeling

**TABLE 8-1** Requirements Determination Questions for Data Modeling

5. *Over what period of time are you interested in these data? Do you need historical trends, current “snapshot” values, and/or estimates or projections? If a characteristic of an object changes over time, must you know the obsolete values?* — **cardinality and time dimensions of data**
6. *Are all instances of each object the same? That is, are there special kinds of each object that are described or handled differently by the organization? Are some objects summaries or combinations of more detailed objects?* — **supertypes, subtypes, and aggregations**
7. *What events occur that imply associations among various objects? What natural activities or transactions of the business involve handling data about several objects of the same or a different type?* — **relationships and their cardinality and degree**
8. *Is each activity or event always handled the same way or are there special circumstances? Can an event occur with only some of the associated objects, or must all objects be involved? Can the associations between objects change over time (for example, employees change departments)? Are values for data characteristics limited in any way?* — **integrity rules, minimum and maximum cardinality, time dimensions of data**