

2 - Machining Fundamentals - Measurement

Manufacturing Processes - 2, IE-352
Ahmed M El-Sherbeeney, PhD
Spring-2014

Learning Objectives

- ❖ Measure to $1/64$ " (.5 mm) with a steel rule
- ❖ Reading an Inch-based Vernier Scale
- ❖ Reading a Metric-based Vernier Scale
- ❖ Measure to 0.001" (.02 mm) using Vernier measuring tools
- ❖ Measure to .0001" (.002 mm) using a Vernier micrometer caliper
- ❖ Use a dial indicator
- ❖ Employ the various helper measuring tools found in a machine shop
- ❖ Identify and use various types of gages found in a machine shop

CONTENTS

- ❖ Steel Rule
- ❖ Micrometer Caliper (inch, metric)
- ❖ Vernier Micrometer
- ❖ Vernier Caliper (inch, metric)
- ❖ Dial Caliper
- ❖ Universal Bevel Protractor
- ❖ Gages

Units of Measurement

The science that deals with **systems of measurement** is called *metrology*. In addition to using **US Conventional units** of measure (inch, foot, etc.), industry is gradually converting to **metric units** of measure (millimeter, meter, etc.), called the ***International System of Units*** (abbreviated **SI**). A micrometer is one-millionth of a meter (0.000001 m).



This rule can be used to make measurements in both US Conventional and SI Metric units.

Reading a Rule

You must first learn to **read a rule** to $1/64''$ and 0.5 mm.

Then, you can progress through $1/1000''$ (0.001'') and 1/100 mm (0.01 mm) by learning to use micrometer and Vernier-type measuring tools.

Finally, you can progress to $1/10,000''$ (0.0001'') and 1/500 mm (0.002 mm) by using the Vernier scale on some micrometers.



Different Types of Rules

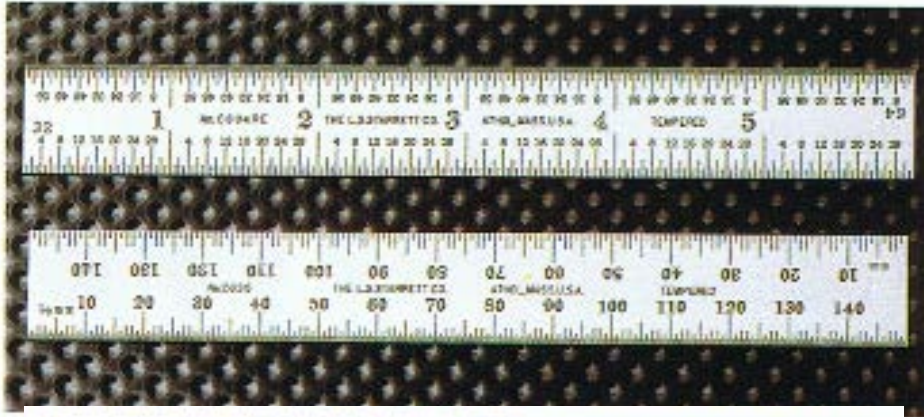

6" steel rule



Rule with adjustable hook

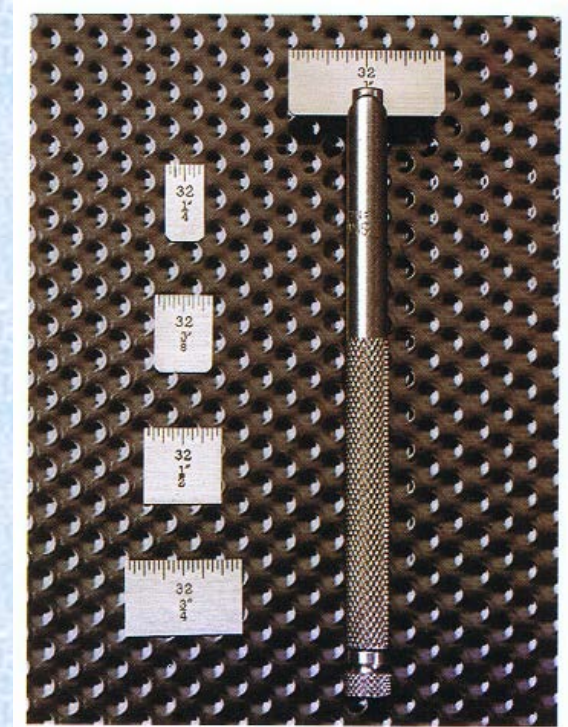

Small rules with holder



Narrow rule

Reading the Rule (US Conventional)

This figure shows the different **fractional divisions** of the inch from $1/8$ to $1/64$ →

The **lines representing the divisions** are called **graduations**.

On many rules, every fourth graduation is numbered on the $1/32$ edge, and every eighth graduation on the $1/64$ edge.

To become familiar with the rule, begin by measuring objects on the $1/8$ and $1/16$ scales. Once you become comfortable with these scales, begin using the $1/32$ and $1/64$ scales.

Some rules are graduated in 10ths, 20ths, 50ths, and 100ths!!

Fractional measurements are always reduced to the lowest terms. A measurement of $14/16$ " is reduced to $7/8$ ", $2/8$ " becomes $1/4$ ", and so on.

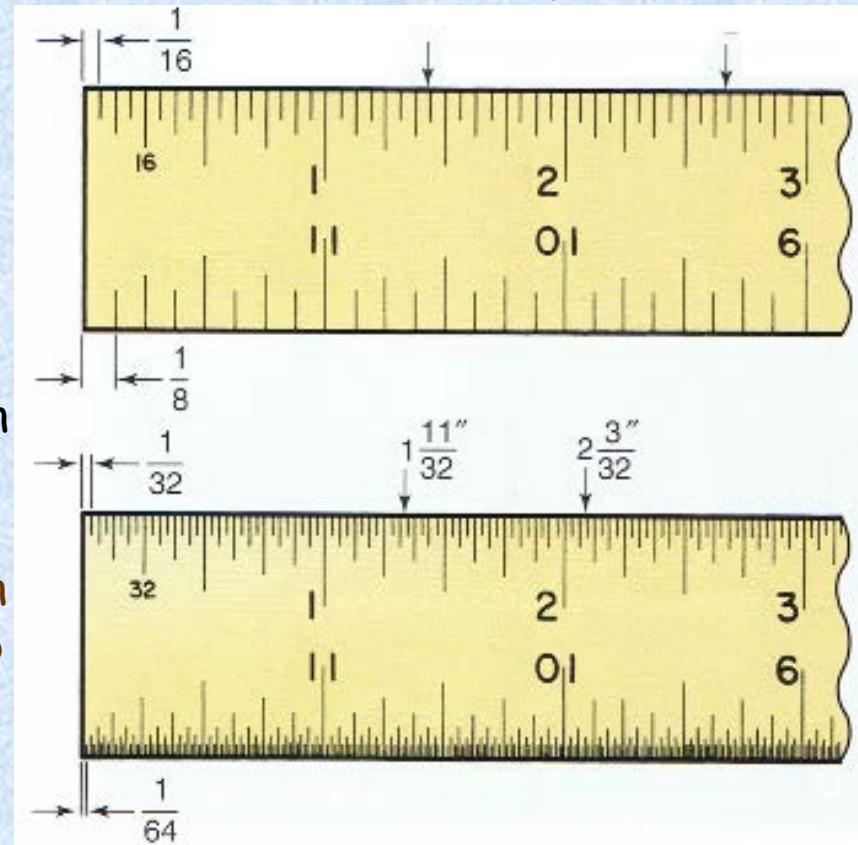

Reading the Rule (Metric)

Most metric rules are divided into **millimeter** or **one-half millimeter** graduations.

They are numbered **every 10 mm (1 cm)**.

The measurement is determined by counting the number of millimeters.

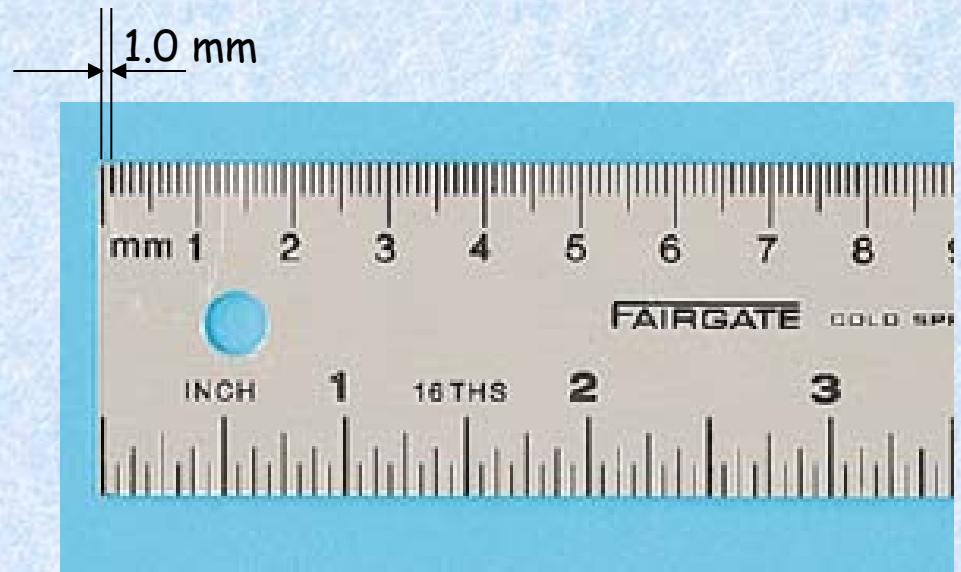

The Micrometer Caliper

A Frenchman, **Jean Palmer**, devised and patented a measuring tool that made use of a **screw thread**, making it possible to read measurements quickly and accurately without calculations.

It consisted of a series of engraved lines on the sleeve and around the thimble.

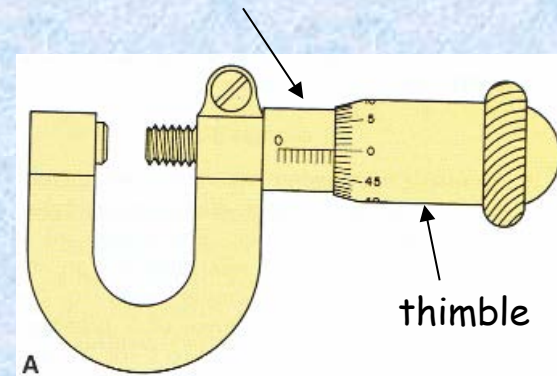

The *micrometer caliper*, also known as a "**mike**," is a precision tool capable of measuring to **0.001"** or **0.01 mm**. When fitted with a **Vernier scale**, it will read to **0.0001"** or **0.002 mm**.

The device, called **Systeme Palmer**, is the basis for the modern **micrometer caliper**.

Types of Micrometers

An *outside micrometer* measures external diameters and thickness,

An *inside micrometer* has many uses, including measuring internal diameters of cylinders, rings, and slots.

- The range of a *conventional inside micrometer* can be extended by fitting longer rods to the micrometer head.
- The range of a *jaw-type inside micrometer* is limited to 1" or 25 mm. The jaw-type inside micrometer has a scale graduated from right to left.

The divisions on the sleeve are numbered in the reverse order of a conventional outside micrometer.



outside



inside



inside

Types of Micrometers

A *micrometer depth gage* measures the depths of holes, slots, and projections. The measuring range can be increased by changing to longer spindles. Measurements are read from right to left.



Types of Micrometers

A *screw-thread micrometer* has a pointed spindle and a double-V anvil shaped to contact the screw thread.

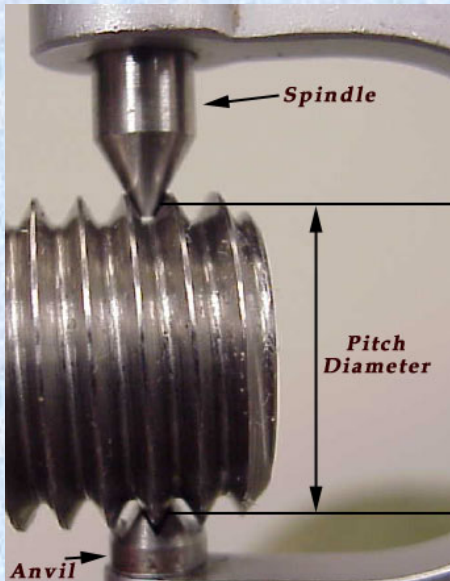
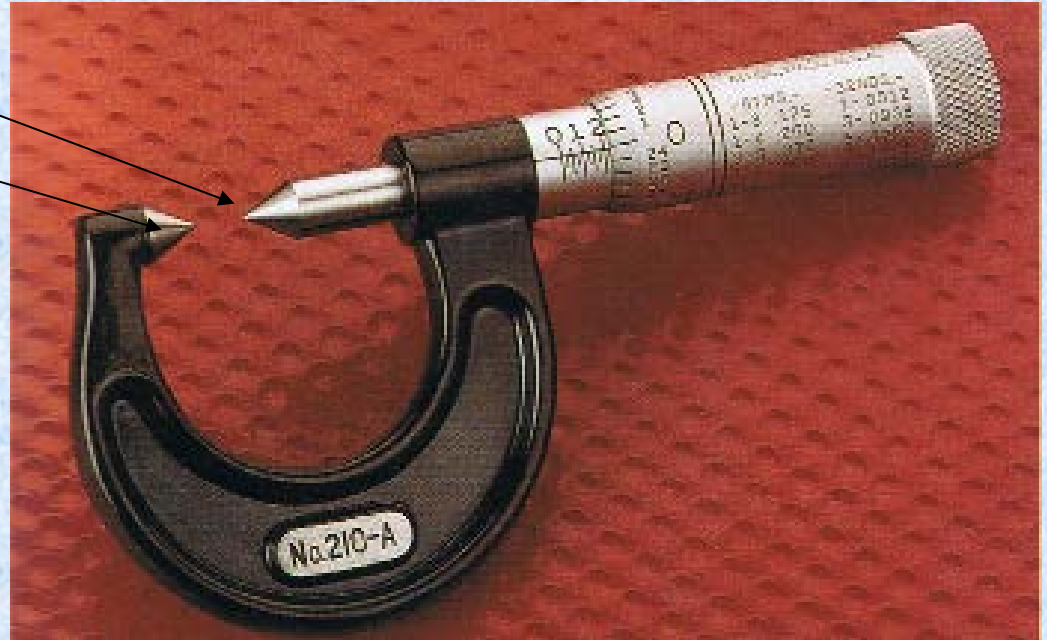

It measures the pitch diameter of the thread, which equals the outside (major) diameter of the thread minus the depth of one thread.

Since each thread micrometer is designed to measure only a limited number of threads per inch, a set of thread micrometers is necessary to measure a full range of thread pitches.

Reading an Inch-Based Micrometer

A micrometer uses a very precisely made screw thread that rotates in a fixed nut.

The screw thread is ground on the *spindle* and is attached to the *thimble*. The spindle advances or recedes from the *anvil* as the thimble is rotated. The threaded section has **40 threads per inch**; therefore, each revolution of the thimble moves the spindle **1/40" (0.025")**.

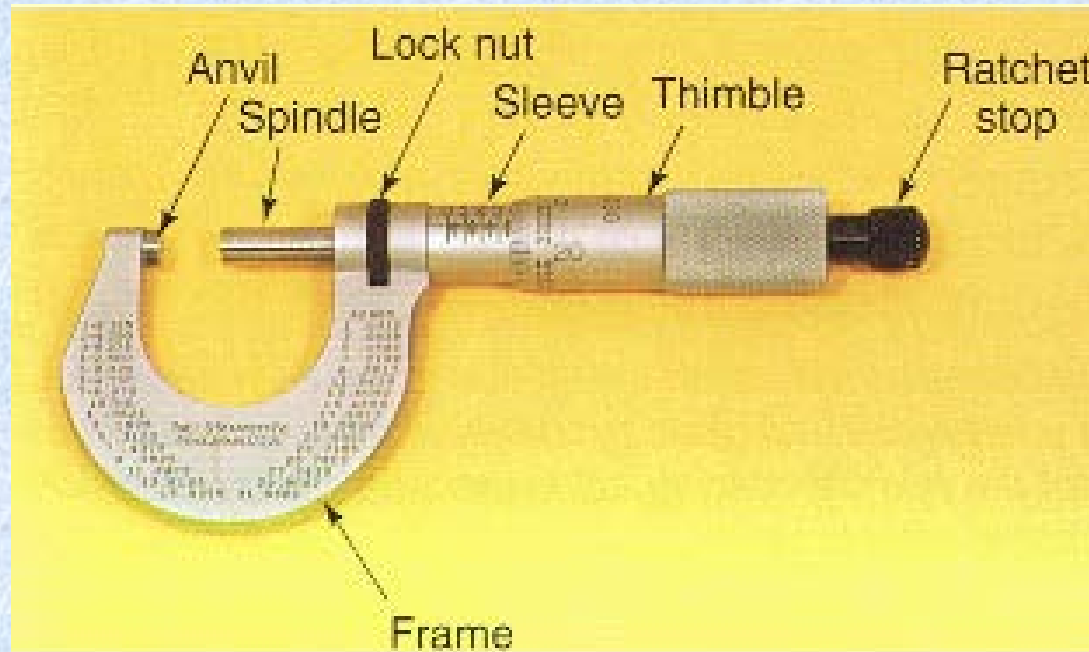

Reading an Inch-Based Micrometer

Every fourth division is numbered, representing 0.1", 0.2", etc.

The line engraved **lengthwise** on the sleeve is **divided into 40 equal parts per inch** (corresponding to the number of threads per inch on the spindle). Each vertical line equals $1/40"$, or 0.025".

The beveled edge of the thimble is divided into **25 equal parts** around its circumference. Each division equals $1/1000"$ (0.001").

On some micrometers, every division is numbered, while every fifth division is numbered on others.

- ✚ The micrometer is read by recording the **highest number** on the sleeve (1 = 0.100, 2 = 0.200, etc.).
- ✚ To this number, **add the number of vertical lines** visible between the number and thimble edge (1 = 0.025, 2 = 0.050, etc.).
- ✚ To this total, **add the number of thousandths** indicated by the line that coincides with the horizontal sleeve line.

Example 1

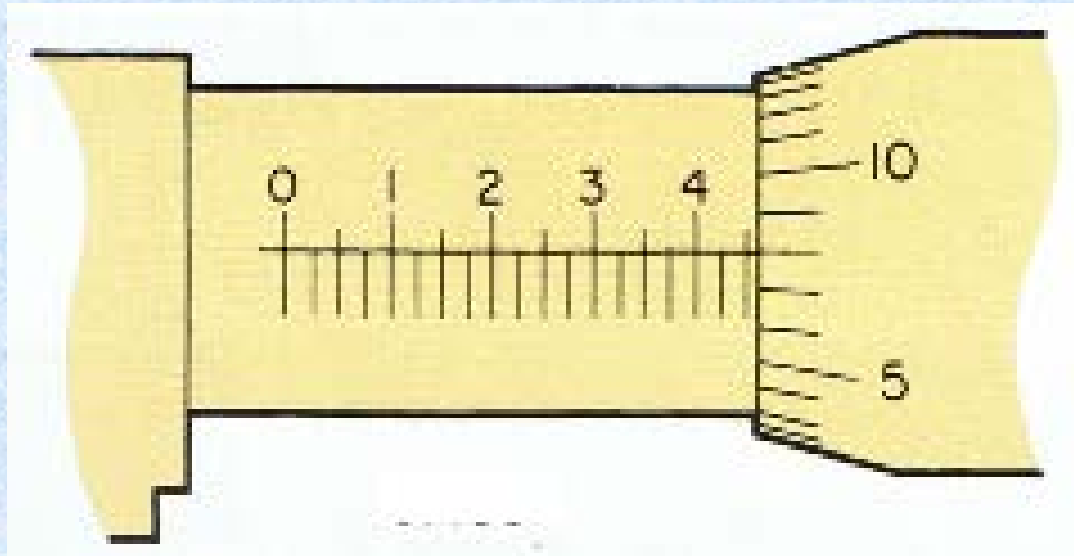

Add the readings from the sleeve and the thimble:

4 large graduations: $4 \times 0.100 = 0.400$

2 small graduations: $2 \times 0.025 = 0.050$

8 thimble graduations: $8 \times 0.001 = \underline{0.008}$

Total mike reading $= 0.458''$

Example 2

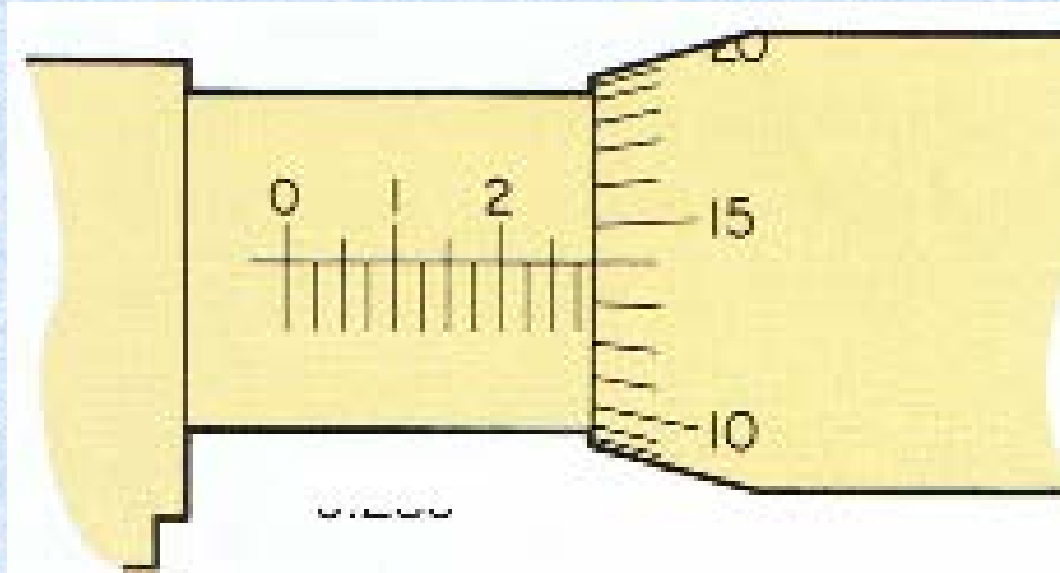

Add the readings from the sleeve and the thimble:

2 large graduations: $2 \times 0.100 = 0.200$

3 small graduations: $3 \times 0.025 = 0.075$

14 thimble graduations: $14 \times 0.001 = \underline{0.014}$

Total mike reading $= 0.289''$

Test yourself!

Read this micrometer:

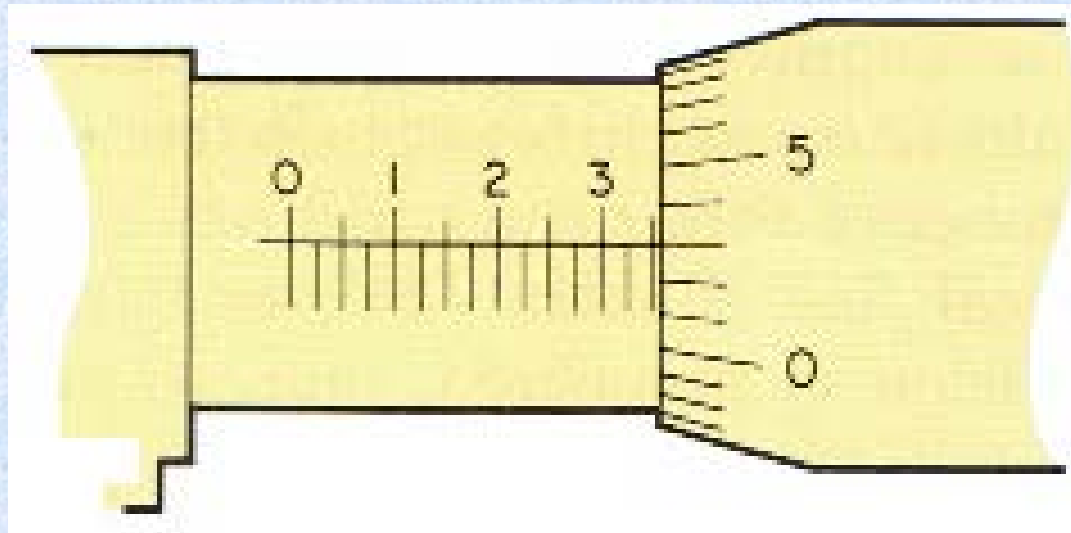

Add the readings from the sleeve and the thimble:

3 large graduations: $3 \times 0.100 = 0.300$

2 small graduations: $2 \times 0.025 = 0.050$

3 thimble graduations: $3 \times 0.001 = \underline{0.003}$

Total mike reading $= 0.353''$

Reading a Vernier Micrometer

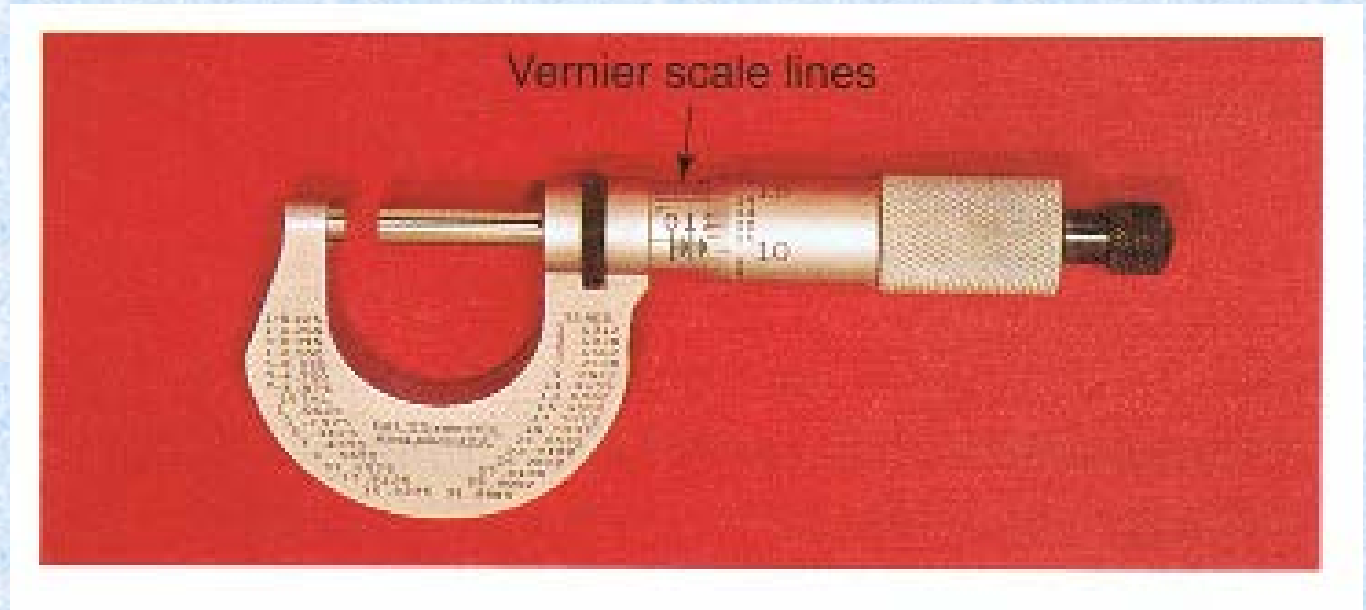

On occasion, it is necessary to measure more precisely than 0.001".

A **Vernier micrometer caliper** is used in these situations.

This micrometer **has a third scale** around the sleeve that will furnish the **1/10,000"** (0.0001") reading

Reading a Vernier Micrometer

The Vernier scale has 11 parallel lines that occupy the same space as 10 lines on the thimble.

The lines around the sleeve are numbered 1 to 10.

The difference between the spaces on the sleeve and those on the thimble is one-tenth of a thousandth of an inch.

To read the Vernier scale, first obtain the thousandths reading, then observe which of the lines on the Vernier scale coincides (lines up) with a line on the thimble. Only one of them can line up (*If the line is 1, add 0.0001 to the reading; if line 2, add 0.0002 to the reading, etc.*)

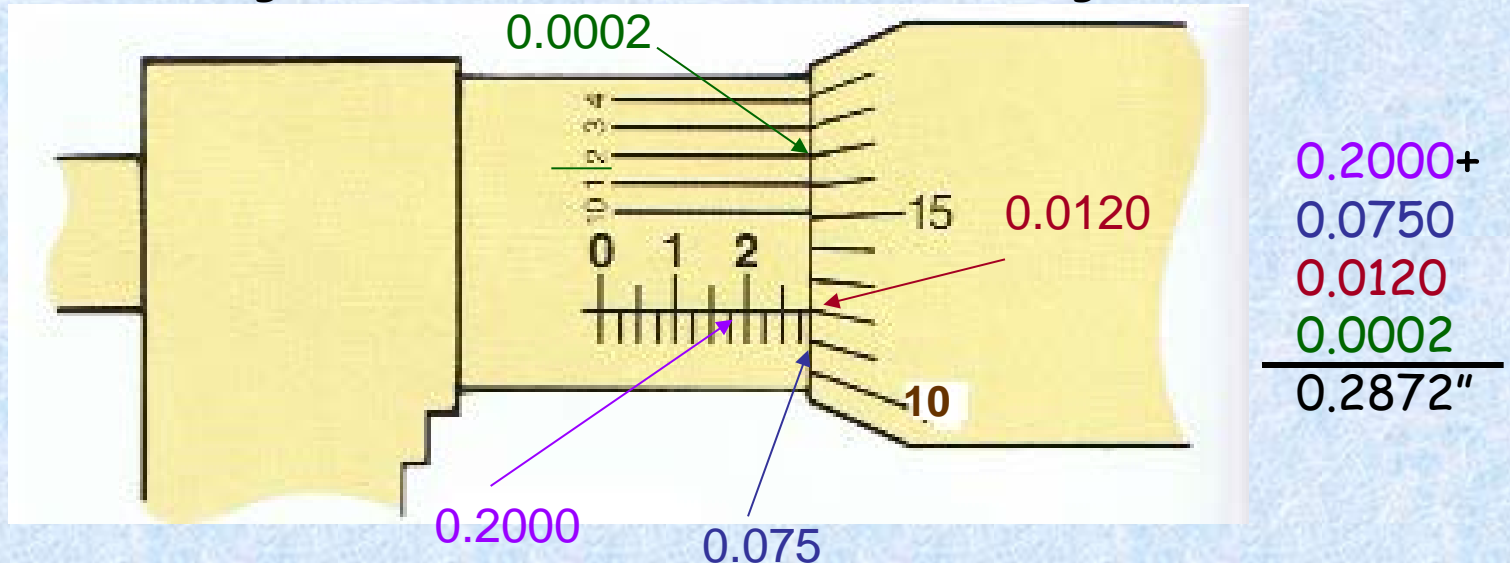

Reading a Metric-Based Micrometer

Follow the same rule:

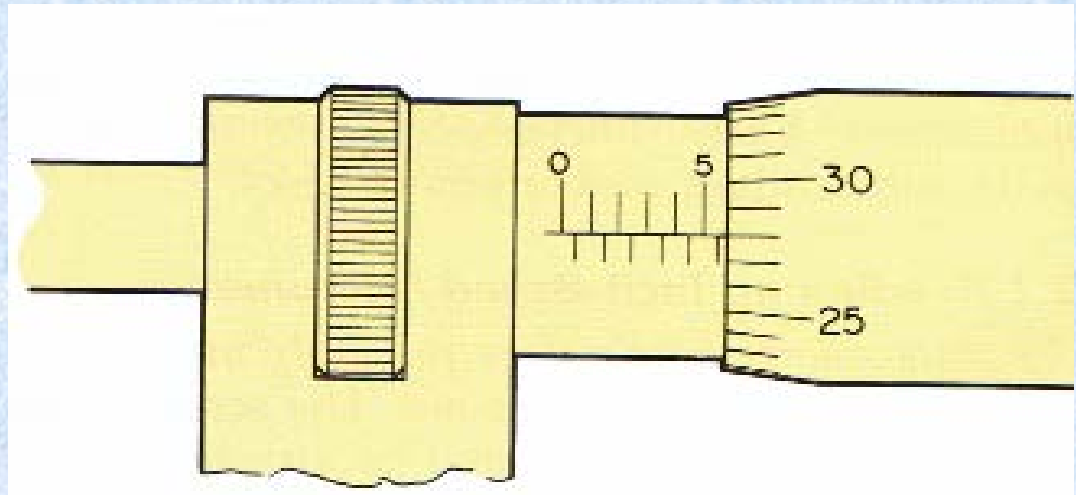

5.00
0.50
0.28
Reading is 5.78 mm

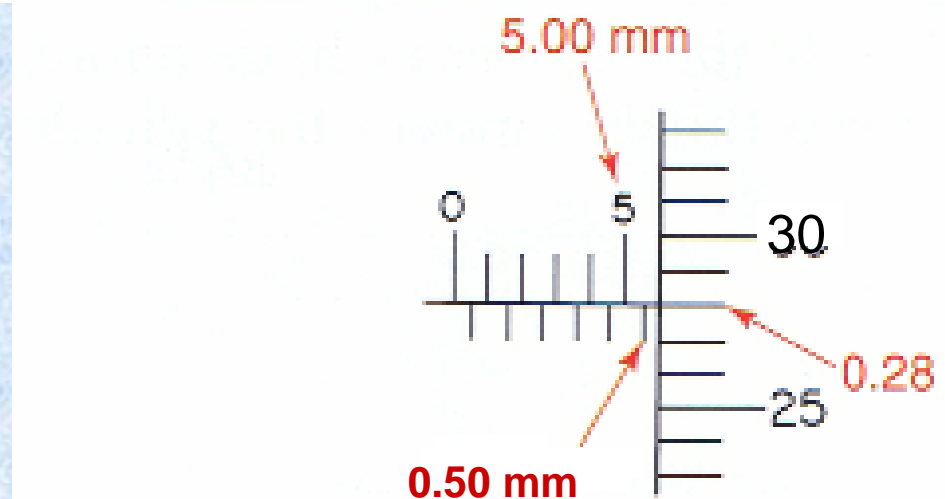

Reading a Metric Vernier Micrometer

Metric Vernier micrometers are read in the same way as standard metric micrometers. However, using the Vernier scale on the sleeve, an additional reading of **two-thousandths of a millimeter** can be obtained.

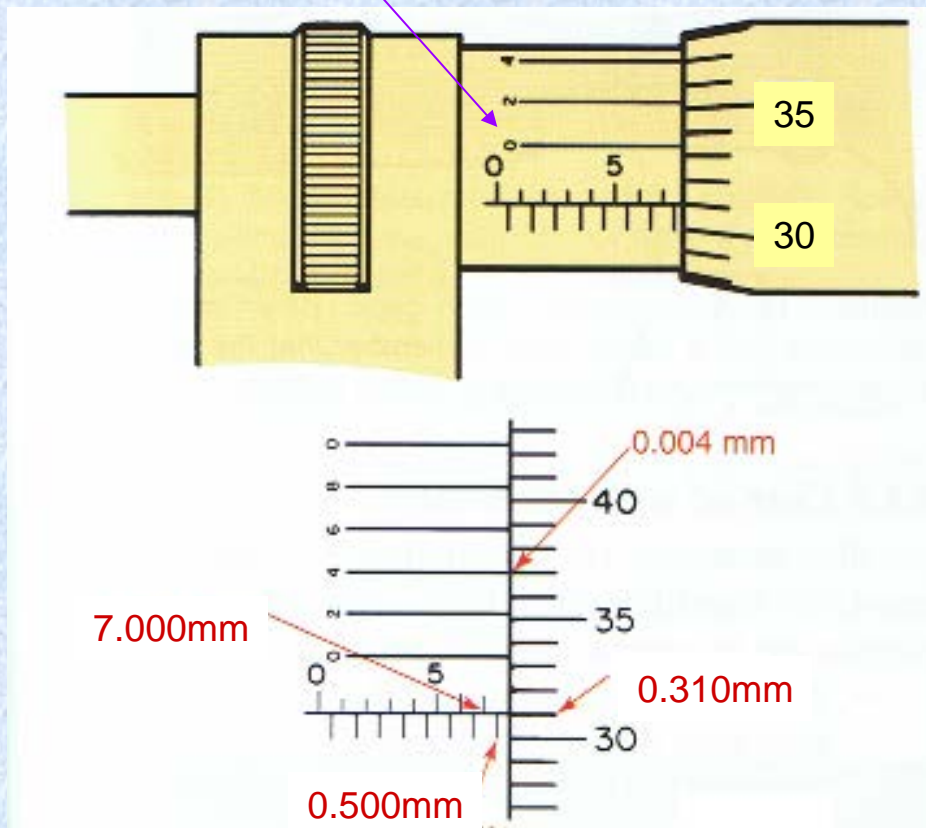

7.000
0.500
0.310
0.004
Reading is 7.814 mm

Using the Micrometer

The proper way to hold a micrometer: The work is placed into position, and the thimble rotated until the part is clamped *lightly* between the anvil and spindle.

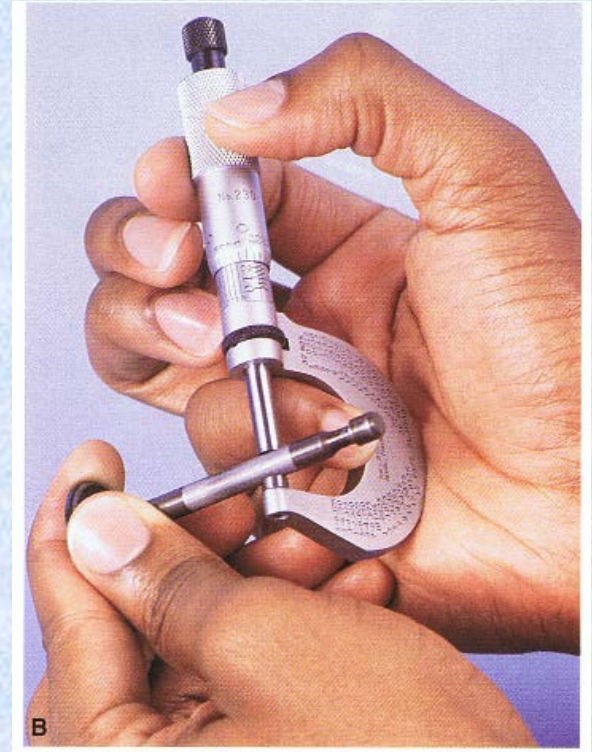

When the piece being measured must also be held, position the micrometer as shown, with a finger in the micrometer frame.

Using the Micrometer

Some micrometers have features to help regulate pressure:

A *ratchet stop* is used to rotate the spindle. When the pressure reaches a predetermined amount, the ratchet stop slips and prevents further spindle turning.

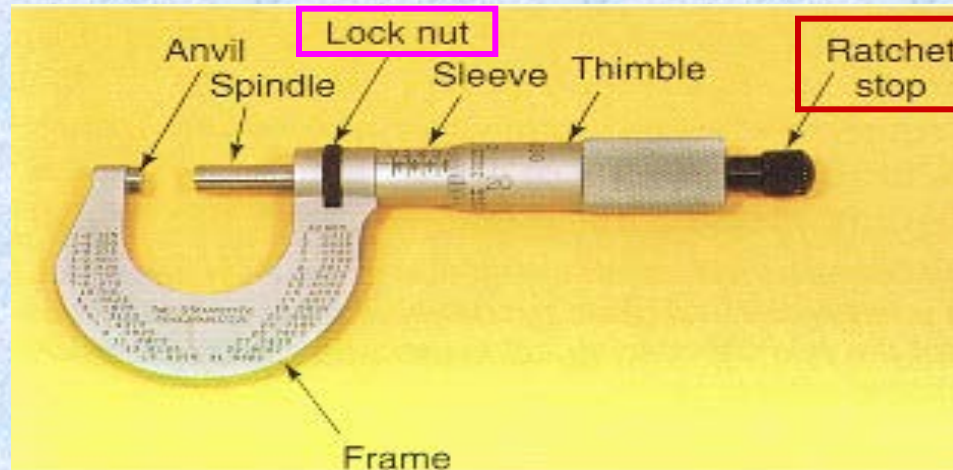

A *lock nut* is used when several identical parts are to be gaged. The nut locks the spindle into place. Gaging parts with a micrometer locked at the proper setting is an easy way to determine whether the pieces are sized correctly.

Vernier Measuring Tools

The Vernier principle of measuring was named for its inventor, **Pierre Vernier**, a French mathematician. The *Vernier caliper* can make accurate measurements to $1/1000''$ (0.001") and 1/50 mm (0.02 mm).

The design of the tool permits measurements to be made over a large range of sizes. It is manufactured as a standard item in **6"**, **12"**, **24"**, **36"**, and **48"** lengths.

SI Metric Vernier calipers are available in mm, **300 mm**, and **600 mm** lengths.

The 6", 12" sizes are most commonly used.

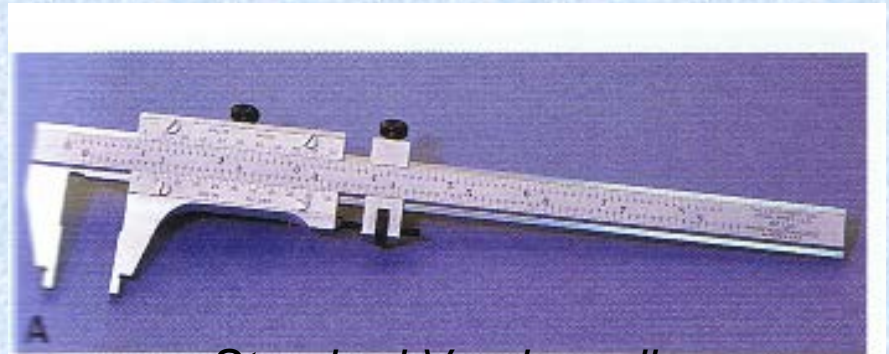

Standard Vernier caliper



Modern digital calipers

Vernier Measuring Tools

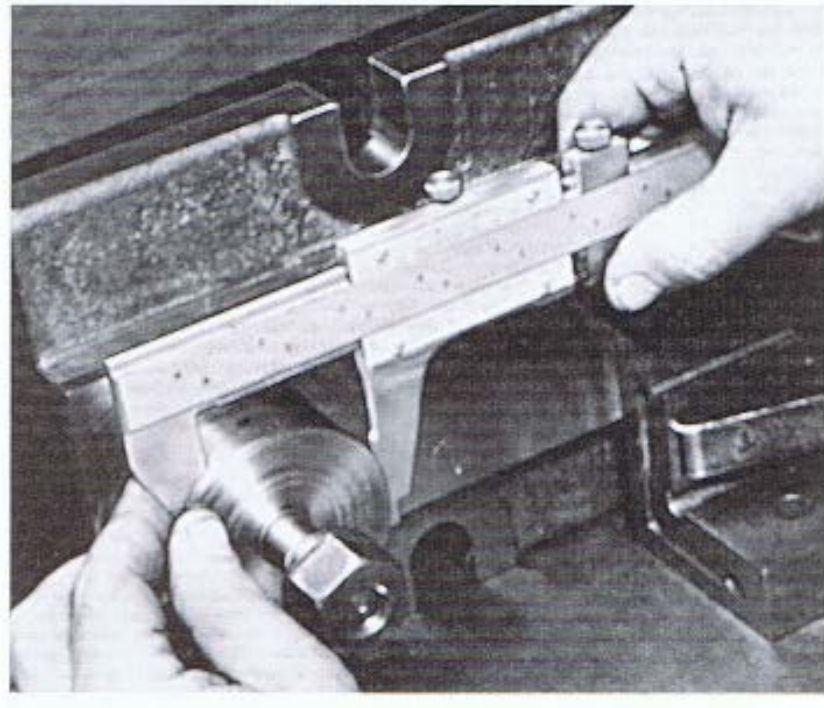

Vernier calipers can be used to make both internal and external measurements.

Vernier Measuring Tools

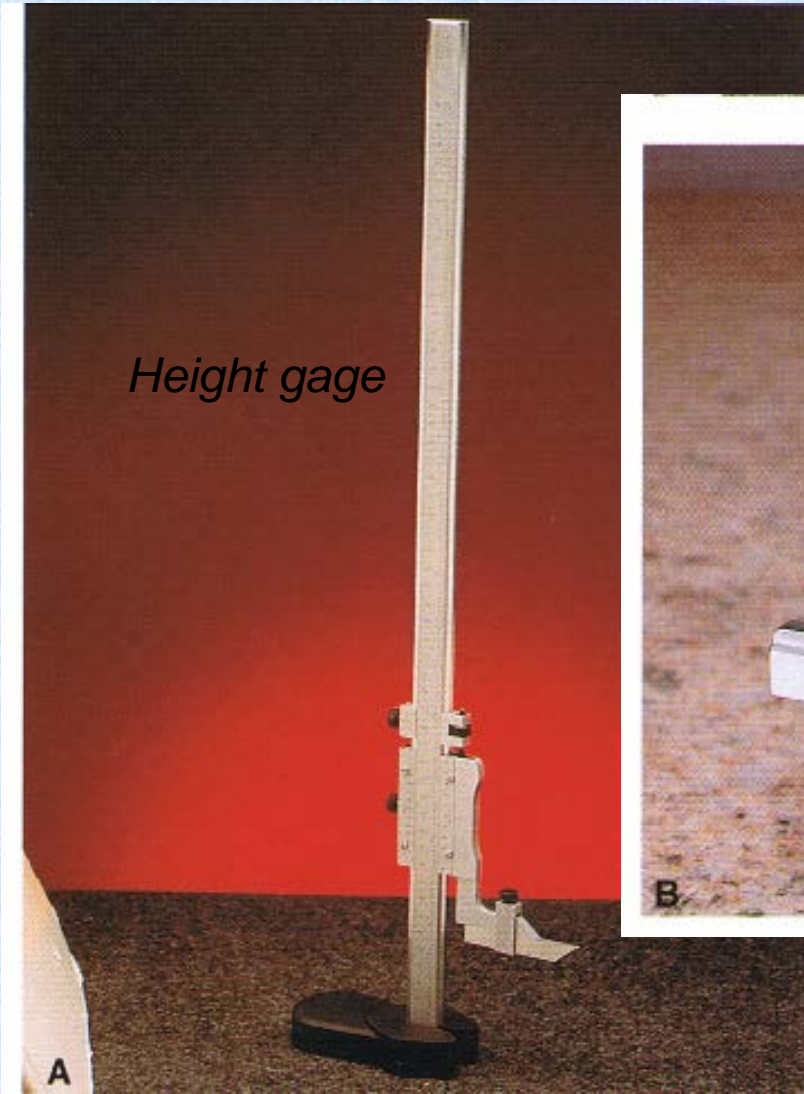

Height gage

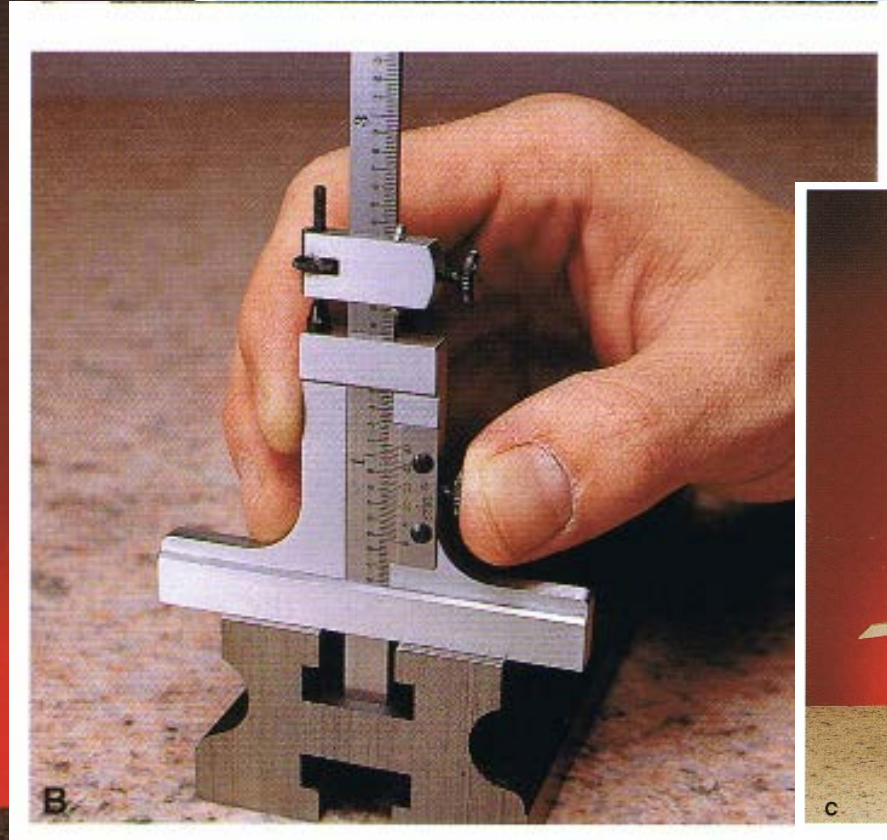

Depth gage



Digital gage

Vernier Measuring Tools

Gear tooth Vernier calipers are used to measure gear teeth, form tools, and threaded tools.

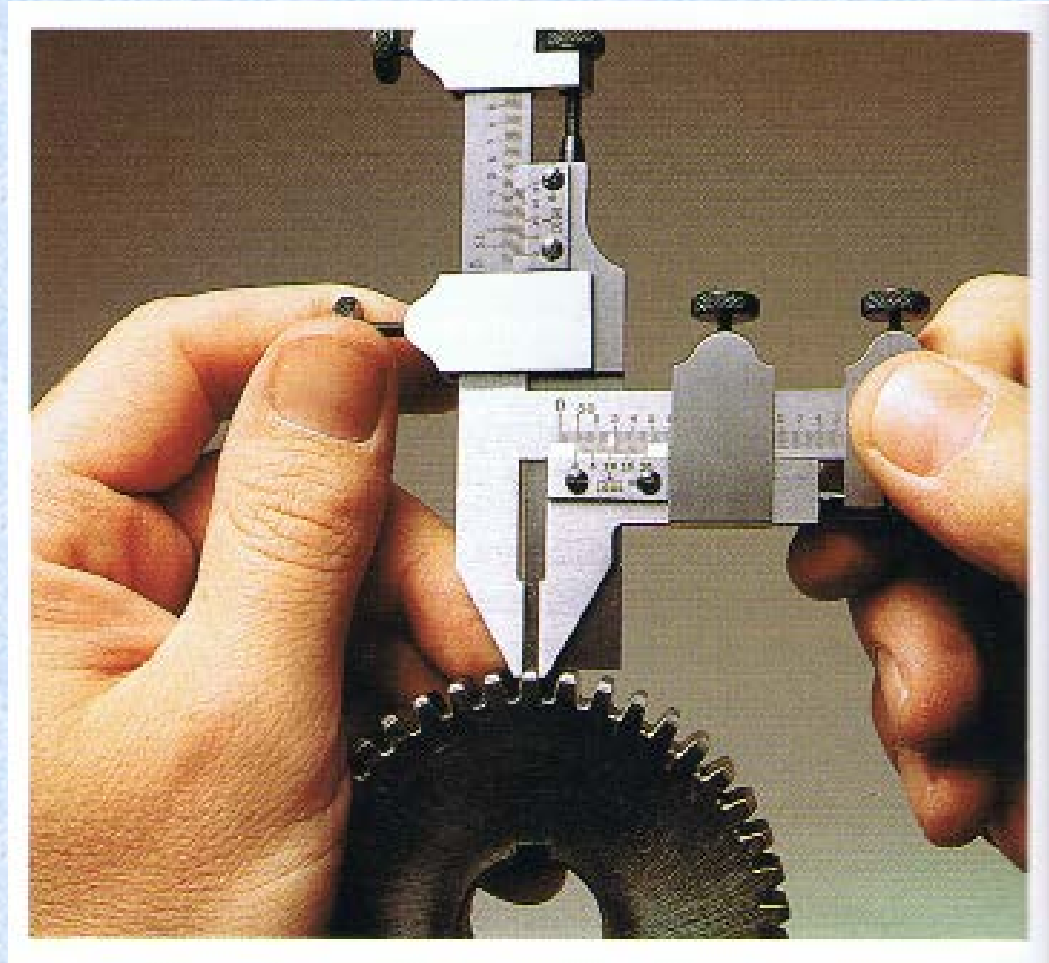

Vernier Scale

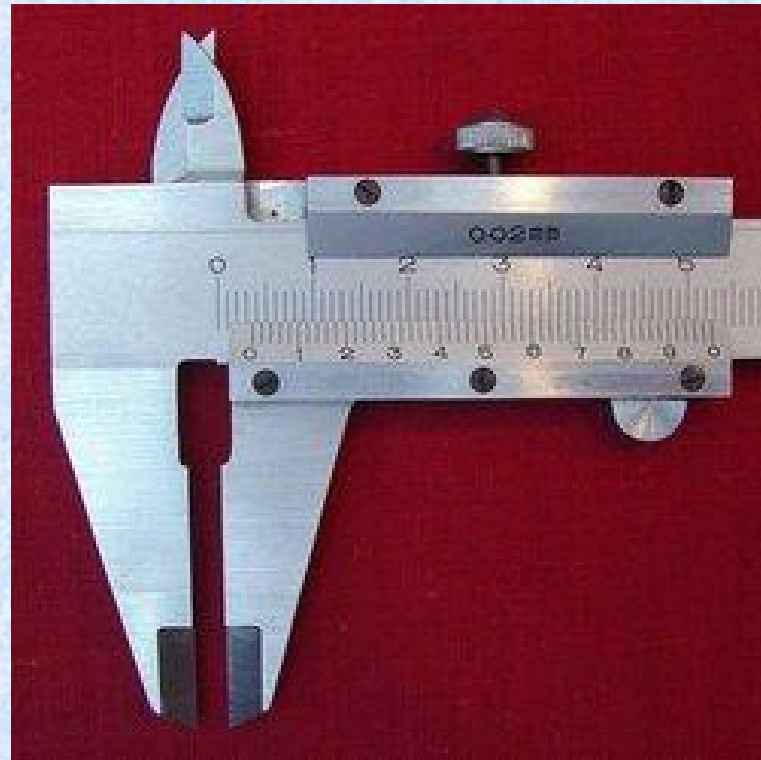
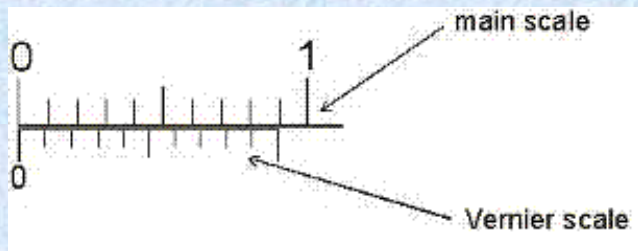

Reading an Inch-based Vernier scale

Two measuring tools
are available:

- **25-division** Vernier plates.
- It can be read to **0.001"**.
- Vernier plate is graduated into **40** equal parts.
- Each graduation is **1/40"** or **0.025**.
- Every four division= **0.1"**

- **50-division** Vernier plates.
- It can be read to **0.001"**.
- Vernier plate is graduated into **50** equal parts.
- Each graduation is **1/50"** or **0.02**.
- Every fifth division= **0.1"**

25-division Vernier plates

Vernier Scale

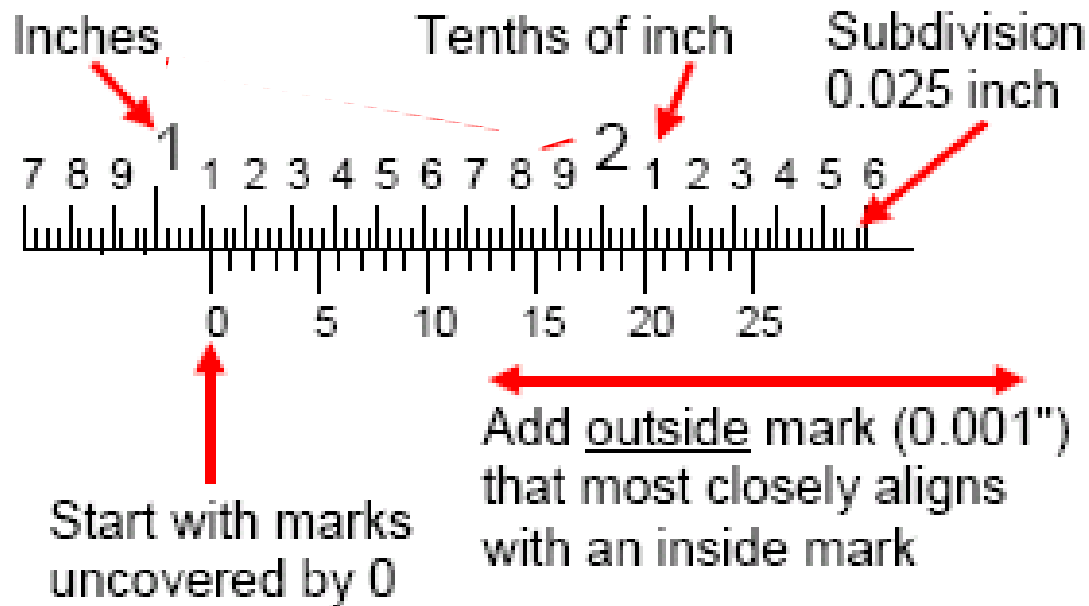

Every four division = 0.1"

25-division Vernier plates

What is the current reading?

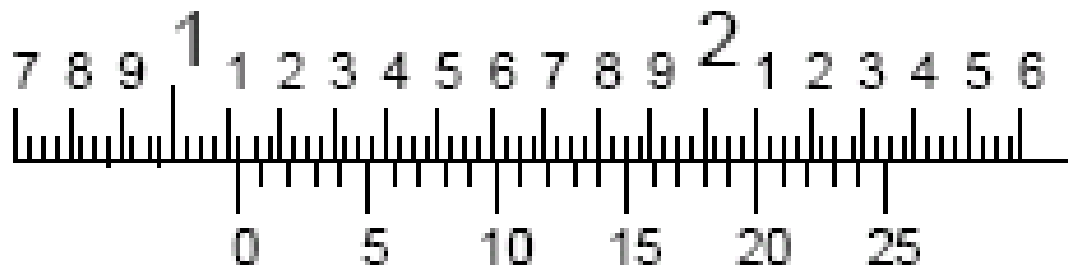

1.0	1.0	+
1×0.1=	0.1	
1×0.025=	0.025	
20×0.001=	0.020	
<hr/>		
	1.145"	

Remember that for a 50-division one, the principle is the same, except that one graduation is 0.050".

How to read a 25-division *metric-based Vernier scale*

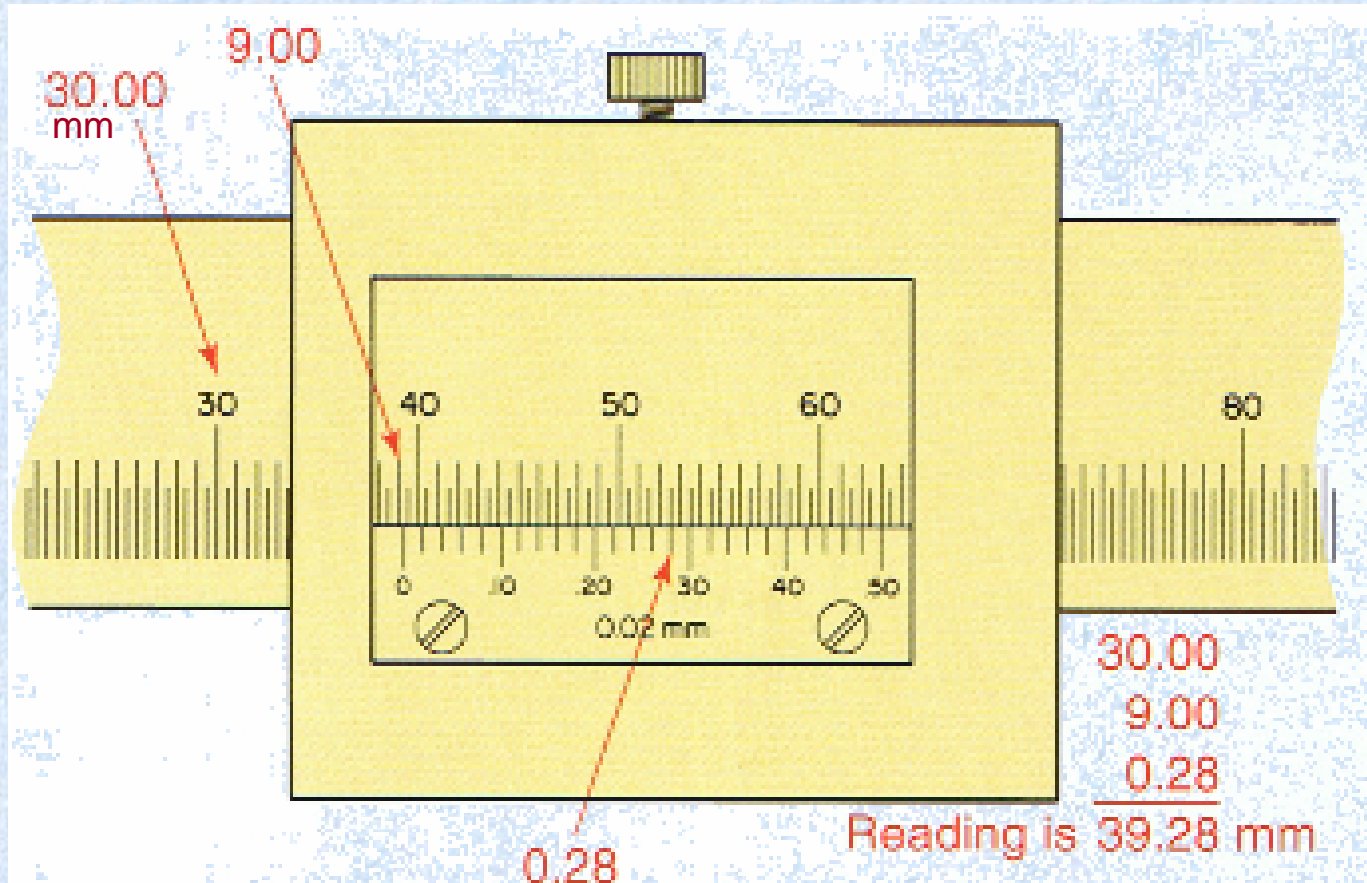

Readings on the scale are obtained in units of two hundredths of a millimeter (0.02 mm)

Test yourself!

Read each Vernier:

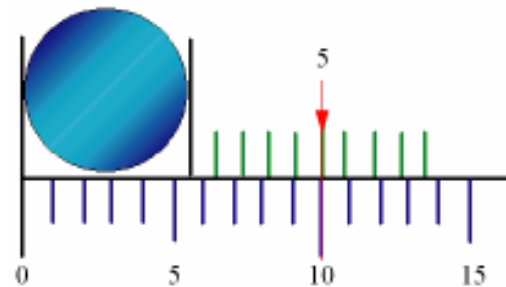
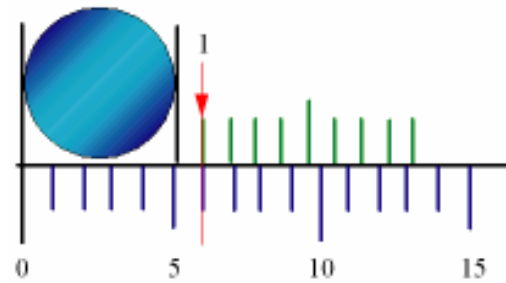
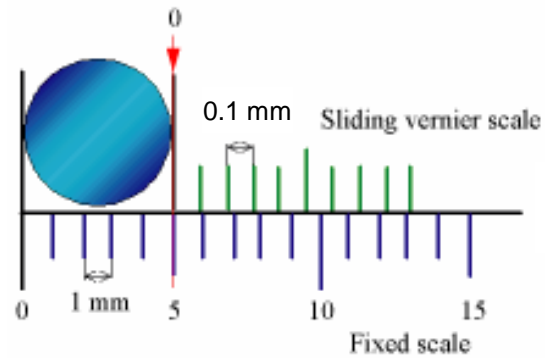
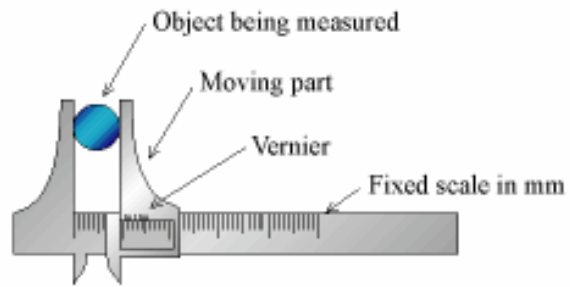

Vernier Caliper

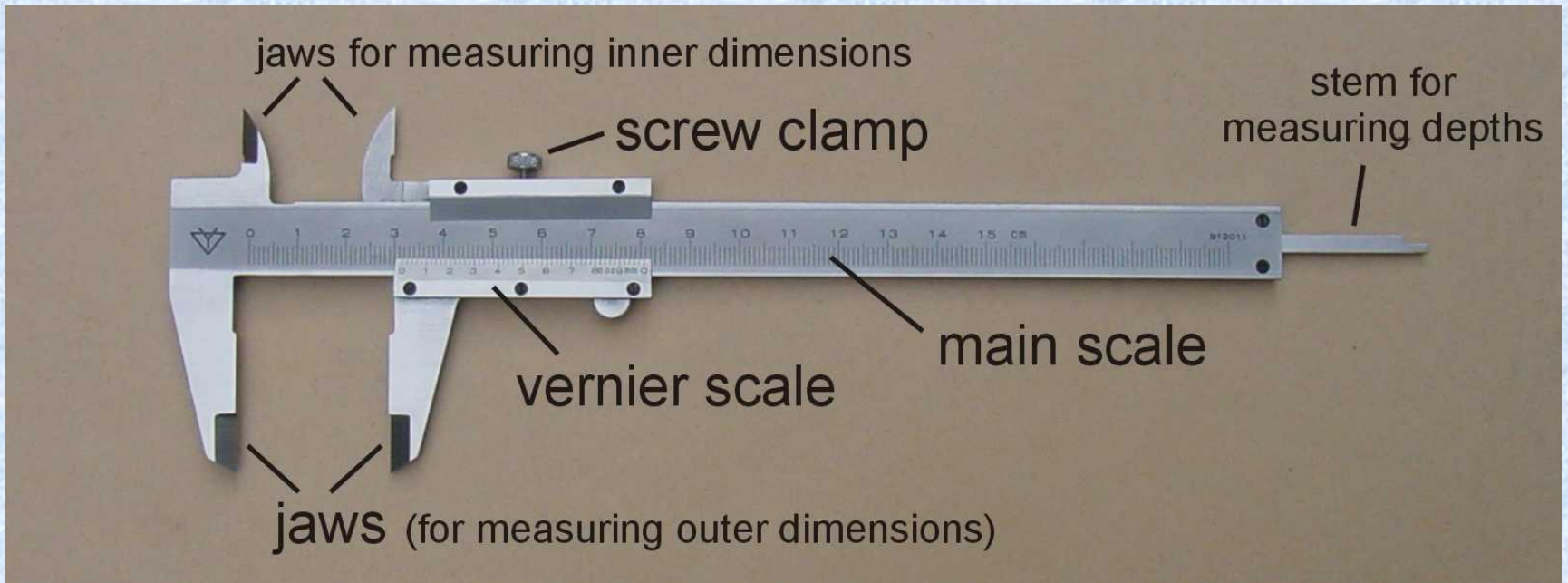

Dial Calipers

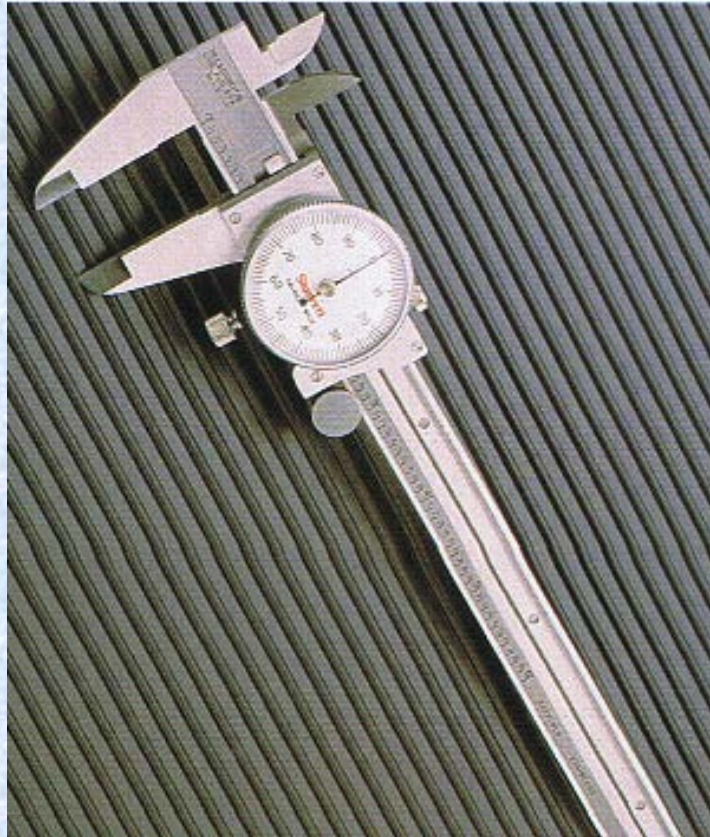

Dial calipers provide direct readings of measurements.

Universal Bevel Protractor

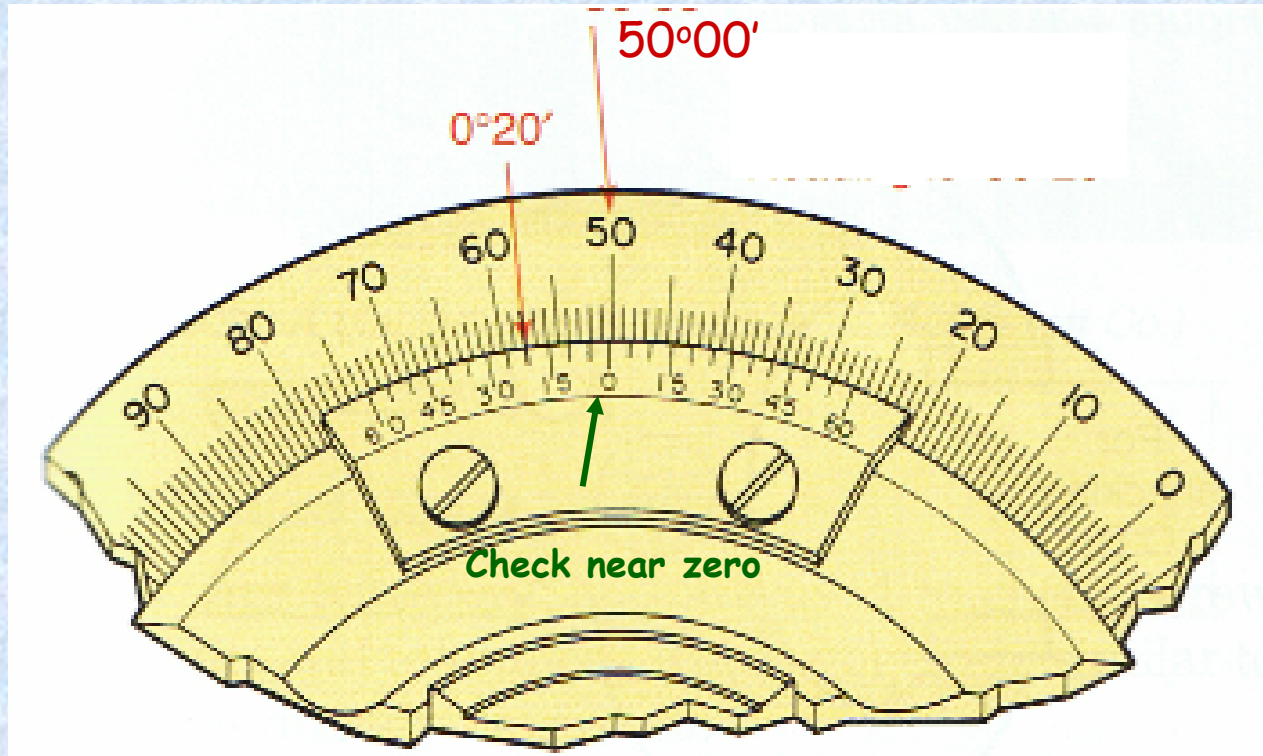

$$\begin{array}{r} 50^{\circ} 00'+ \\ \underline{0^{\circ} 20'} \\ 50^{\circ} 20' \end{array}$$

Degree ($^{\circ}$)— Regardless of its size, a circle contains 360° . Angles are also measured by degrees.

Minute ($'$)—A minute represents a fractional part of a degree. If a degree is divided into 60 equal parts, each part is one minute. A foot mark ($'$) is used to signify minutes (e.g. $30^{\circ} 15'$).

Second ($''$)—Minutes are divided into smaller units known as seconds. There are 60 seconds in one minute.

Vernier scale for reading the angle

This Vernier scale allows the angle to be read to an accuracy of about 0.05 degrees.

19.8 degrees →

1- Begin by reading the integer of the angle directly - here, this is 19 degrees. Use the next smallest number below the line pointed-to by the arrow ("1" in the figure shown).

2- Next, the fractional angle can be read using the Vernier. Simply follow the lines across on the Vernier scale (the outside) until you locate the ONE which best lines-up with a line (any line) on the circular inner scale.

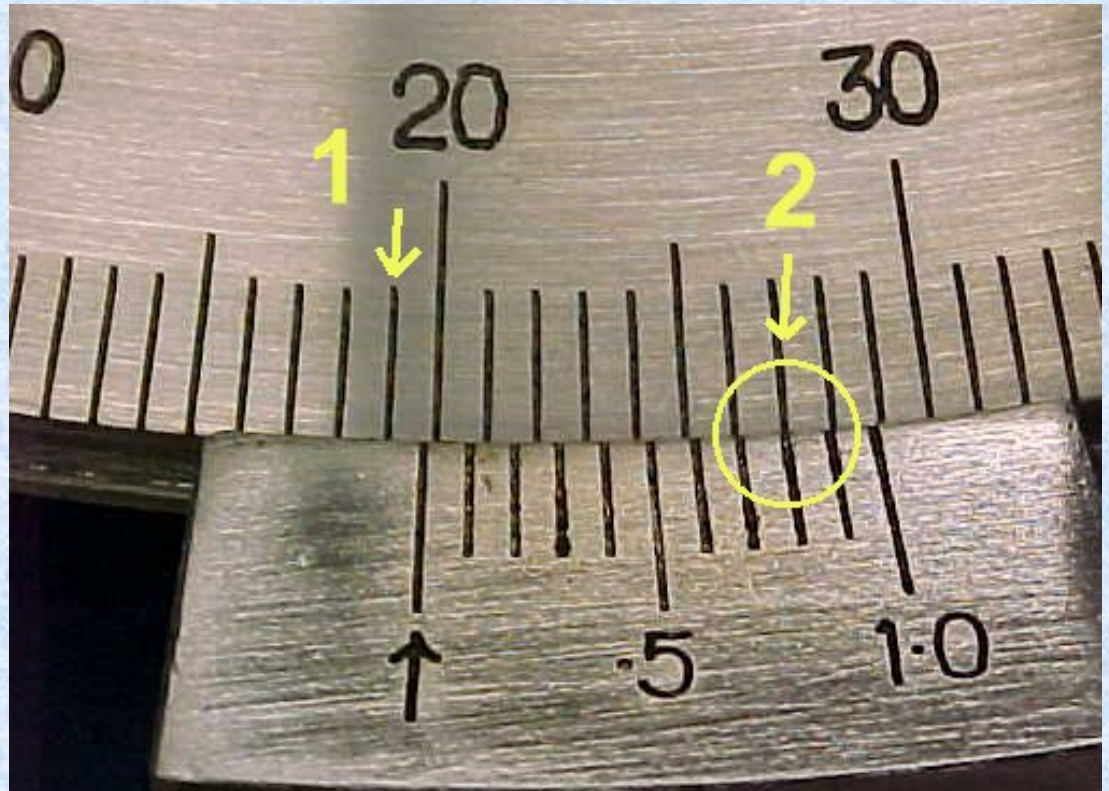

Gages

Gaging involves checking parts with various gages.

Gaging simply shows whether the piece is made within the specified tolerances.

Examples of Gages: plug gages, ring gages, snap gage, thread gage, and optical gages.

When great numbers of an item with several critical dimensions are manufactured, it might not be possible to check each piece.

It then becomes necessary to decide how many randomly selected pieces must be checked to ensure satisfactory quality.

This technique is called *statistical quality control*.

Plug Gage

Plug gages are used to check whether hole diameters are within specified tolerances.

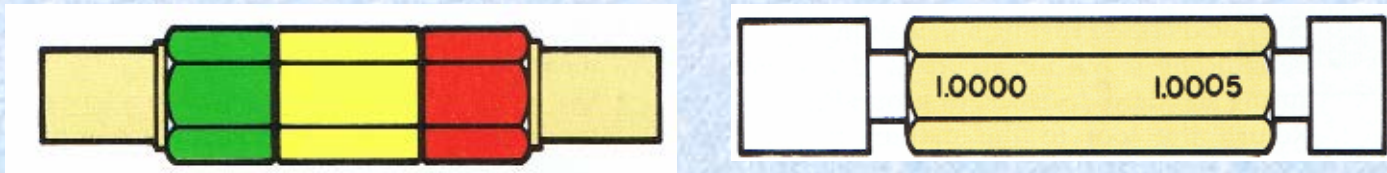

A double end cylindrical plug gage has two gaging members known as go and no-go plugs.

- ❖ *The go plug should enter the hole with little or no interference.*
- ❖ *The no-go plug should not fit.*

Ring Gage

External diameters are checked with **ring gages**.

The go and no-go ring gages are separate units, and can be distinguished from each other by a groove cut on the knurled outer surface of the no-go gage.

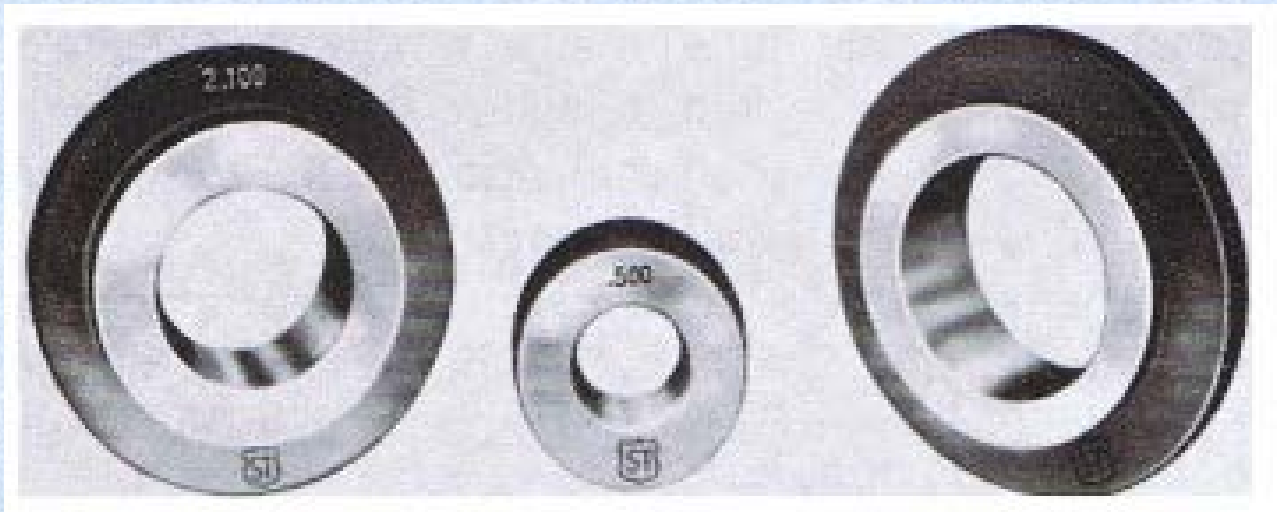

Snap Gage

A *snap gage* serves the same purpose as a ring gage. Snap gages are designed to check internal diameters, external diameters, or both. There are three general types:

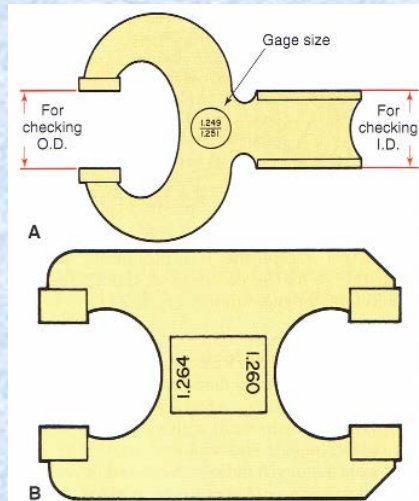

A nonadjustable snap gage is made for one specific size.



An adjustable snap gage can be adjusted through a range of sizes.

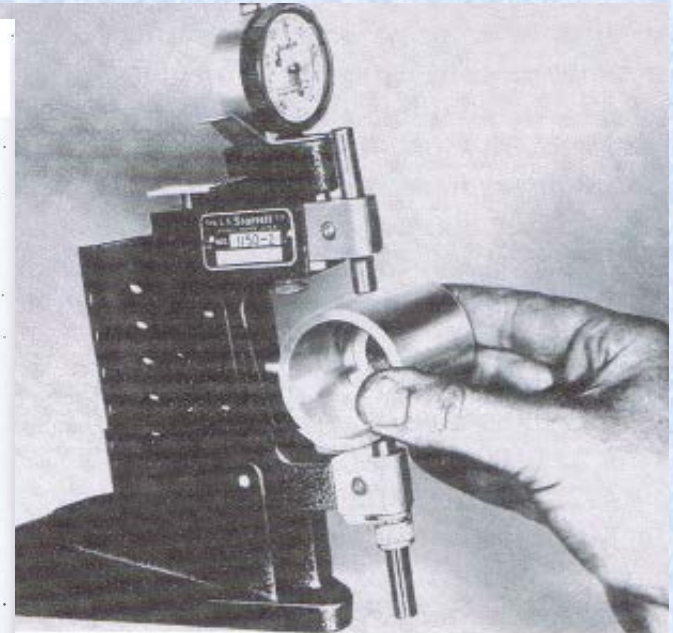

A dial indicator snap gage measures the amount of variation in the part measurement.

Please Visit the following webpages

<http://en.wikipedia.org/wiki/Micrometer>

<http://www.stefanelli.eng.br/en/index.html> (very good)

<http://members.shaw.ca/ron.blond/index.html> (very good)

<http://longislandindicator.com/p7.html> (calibration of gages)