

Spectrophotometer

An instrument used to make absorbance , transmittance or emission measurements is known as a spectrophotometer :

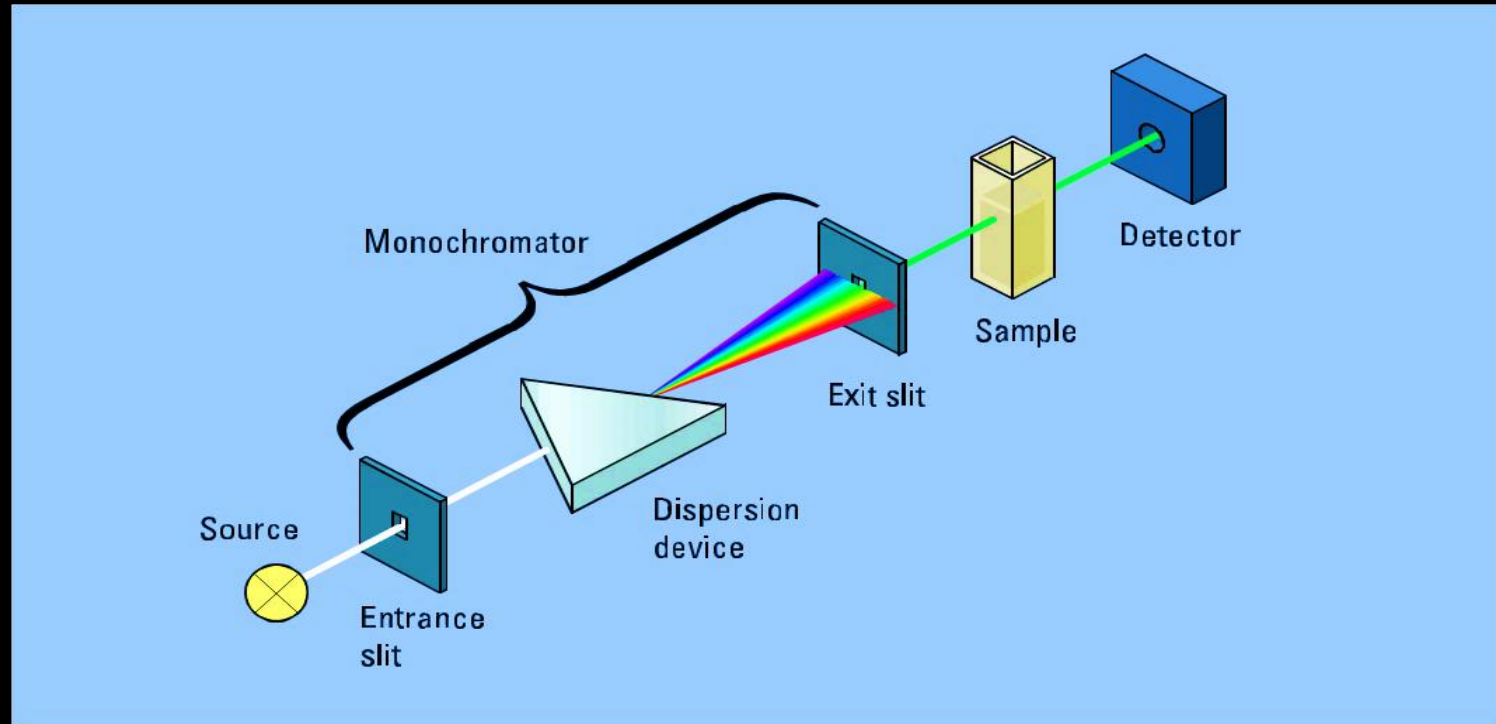

Spectrophotometer components

Excitation sources

| | |
|------------------------|--------------------|
| Deuterium Lamp | UV |
| Tungsten Lamp | UV-vis |
| Laser | X-ray, UV, vis, IR |
| X-ray tube | X-ray |
| Mercury lamp | UV-vis |
| Xenon lamp | UV-vis |
| Silicon carbide globar | IR |
| Flame | |
| Furnaces | |
| Plasmas | |
| Hollow-cathode lamp | |

Monochromators

Filters
Grating+slit
prism

Detectors

PMT
CCD/CID
Photodiode
Thermocouple
MCT
Pyroelectric detector

Components of A Spectrophotometer

Sources

- 1- Wavelength selectors (filters, monochromators)
- 2- Sample containers
- 3- Detectors
- 4- Readout devices

Spectrophotometer components can be arranged as a single or a double beam instrument .

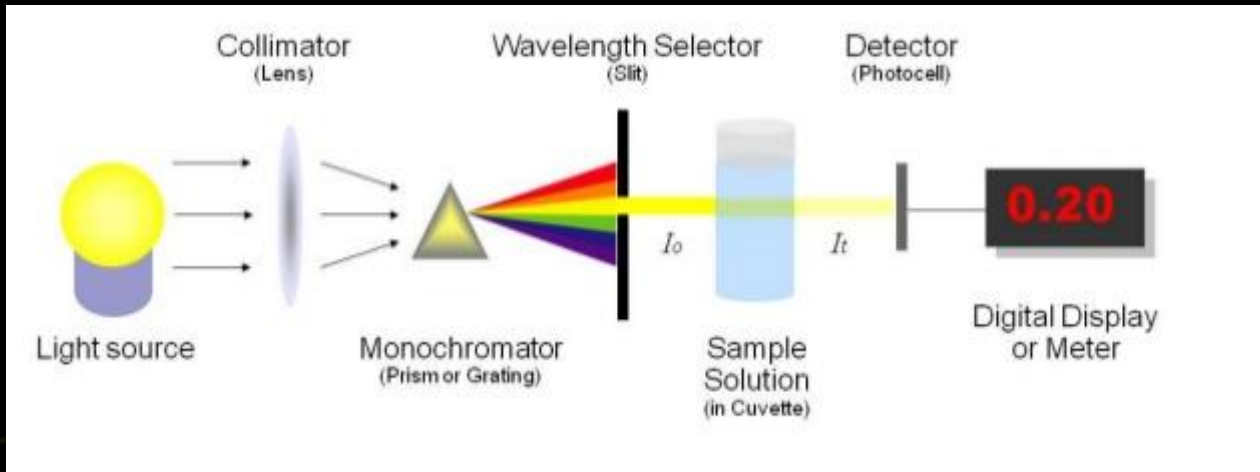

Radiation Sources

Sources of radiation should be stable and of high intensity
Sources used in molecular UV-Vis Spectrophotometers are continuous sources.

Continuous sources emit radiation of all wavelengths within the spectral region for which they are to be used.

Line sources : emit monochromatic radiation and will be discussed in later units , example Hollow Cathode Lamp (HCL).

Radiation sources

The most common continuous sources are :

a) Tungsten lamp: Vis (320 nm~2500 nm)

heat solid filament to glowing, light emitted

b) Deuterium lamp: UV (200~400 nm)



In presence of arc, some of the electrical energy is absorbed by D_2 (or H_2) which results in the disassociation of the gas and release of light

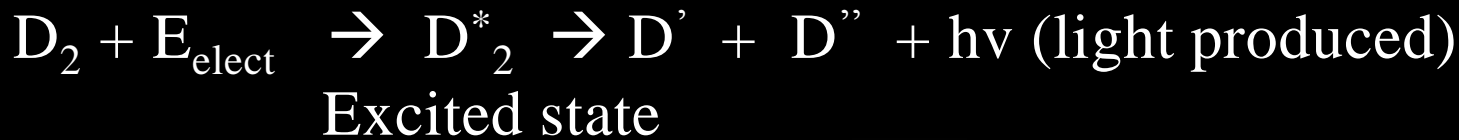

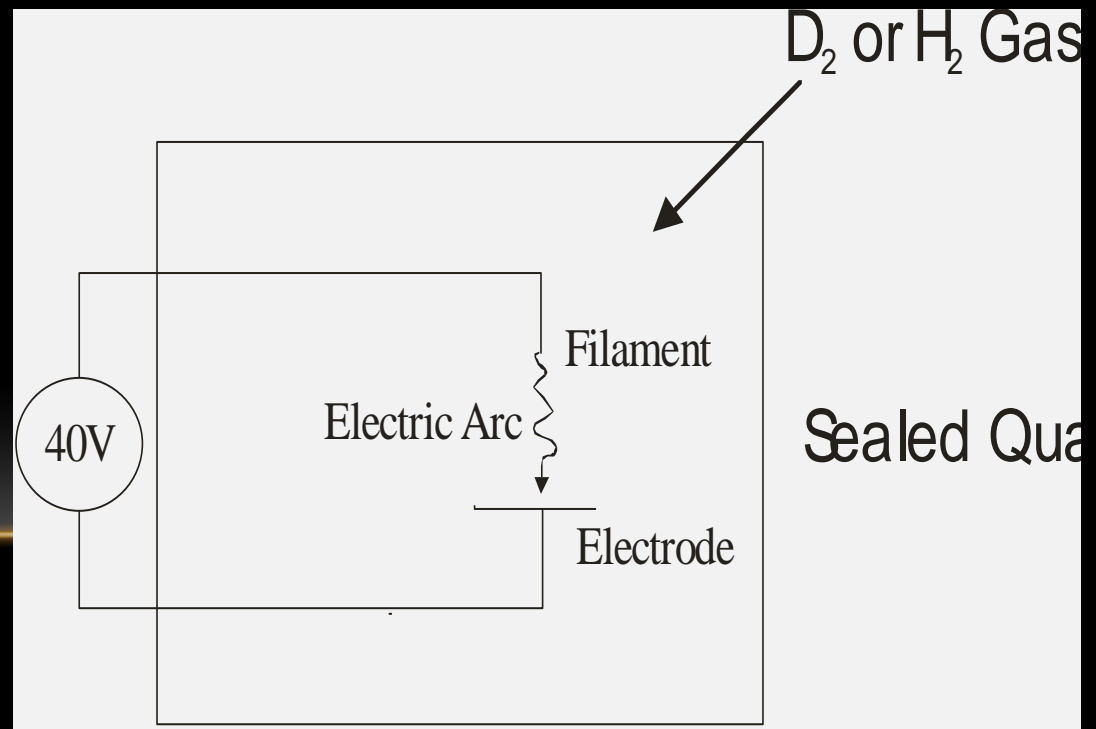
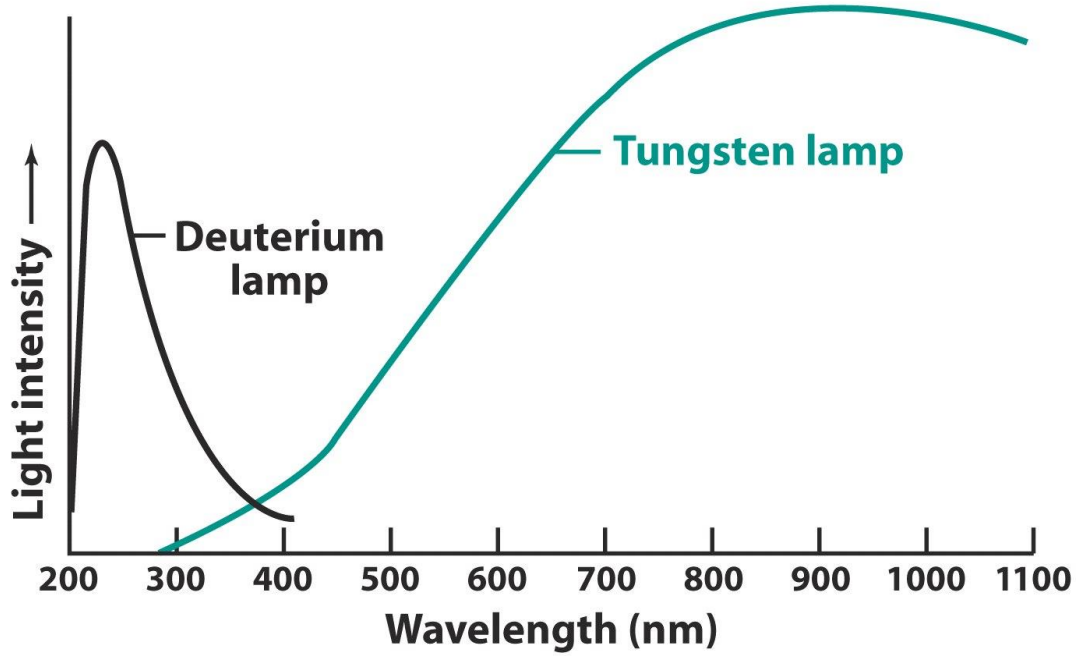

Selection of wavelength

Absorbance measurements are always carried out at **fixed wavelength** (using monochromatic light). When a wavelength is chosen for **quantitative analysis**, three factors should be considered

1. Wavelength should be chosen to give the **highest possible sensitivity**. This can be achieved **by selecting λ_{\max}** or in general the wavelengths at which the absorptivity is relatively high .

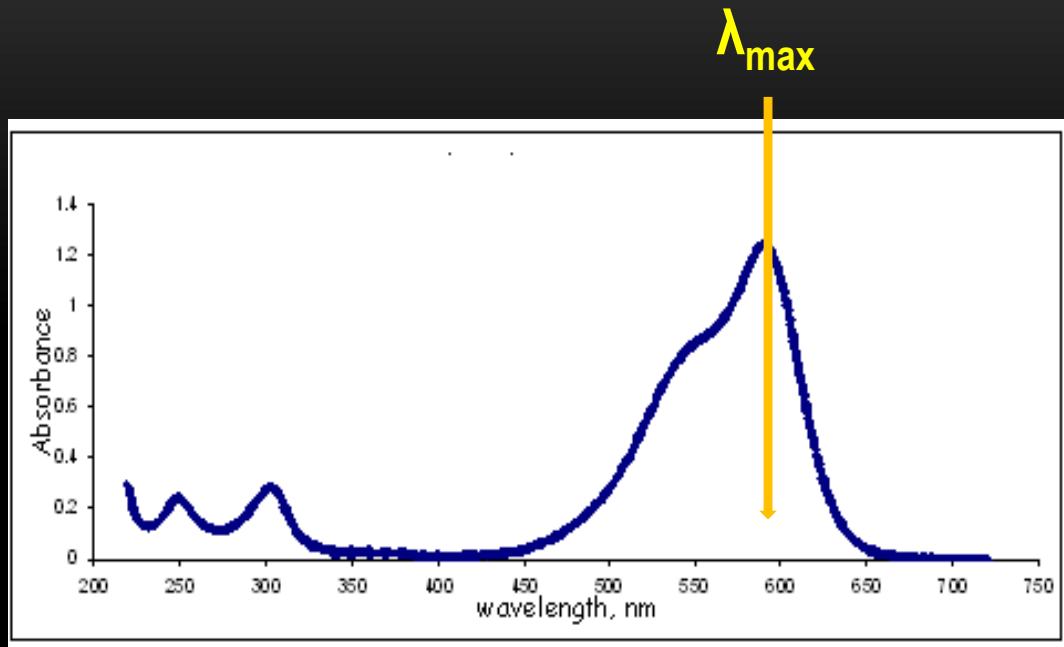

λ_{max} - wavelength where maximum absorbance occurs.

By performing the analysis at such wavelengths, it will be sure that **the lowest sample concentration** can be measured with fair accuracy.

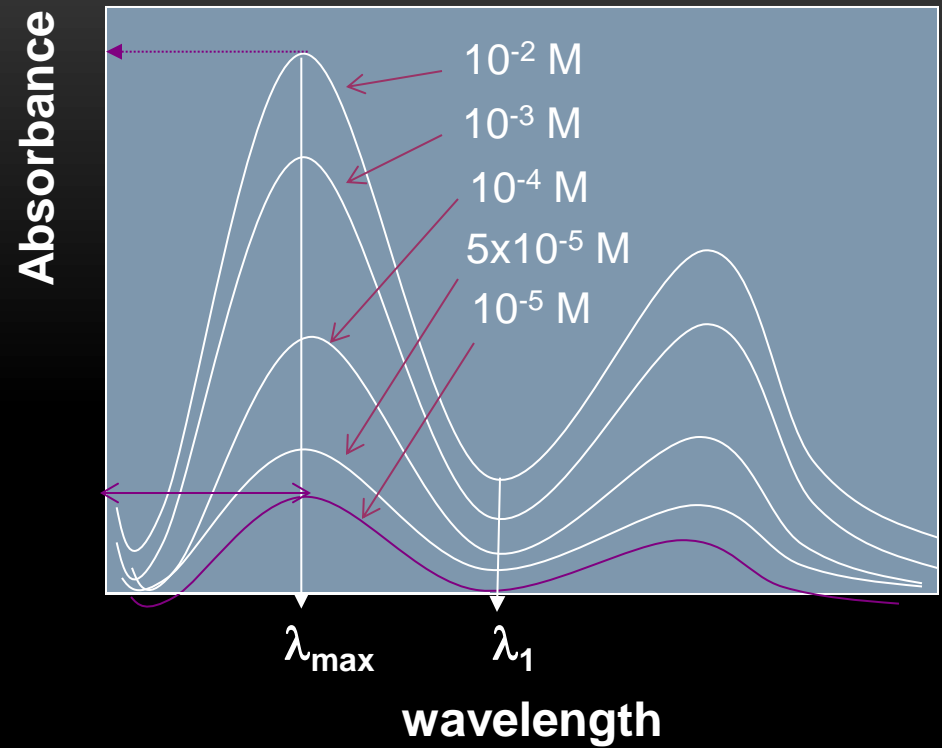

For example, in the above figure the lowest sample concentration (**10^{-5} M**) can be measured with good accuracy at λ_{max} , while at other wavelength (λ_1), it may not be detected at all.

2. It is preferable to choose the wavelength at which the absorbance will not significantly change if the wavelength is slightly changed, i.e., $\Delta A / \Delta \lambda$ is minimum.

At a wavelength corresponding to **broad horizontal band on the spectrum** (band A), the radiation is mainly absorbed to the same extent ($\Delta A / \Delta \lambda \sim \text{zero}$).

However on a **steep portion of the spectrum** (band B), the absorbance will change greatly if the wavelength is changed ($\Delta A / \Delta \lambda$ is large) . Thus on repeating the absorbance measurements, you might get **different readings** and **the precision** of the measurements will be poor.

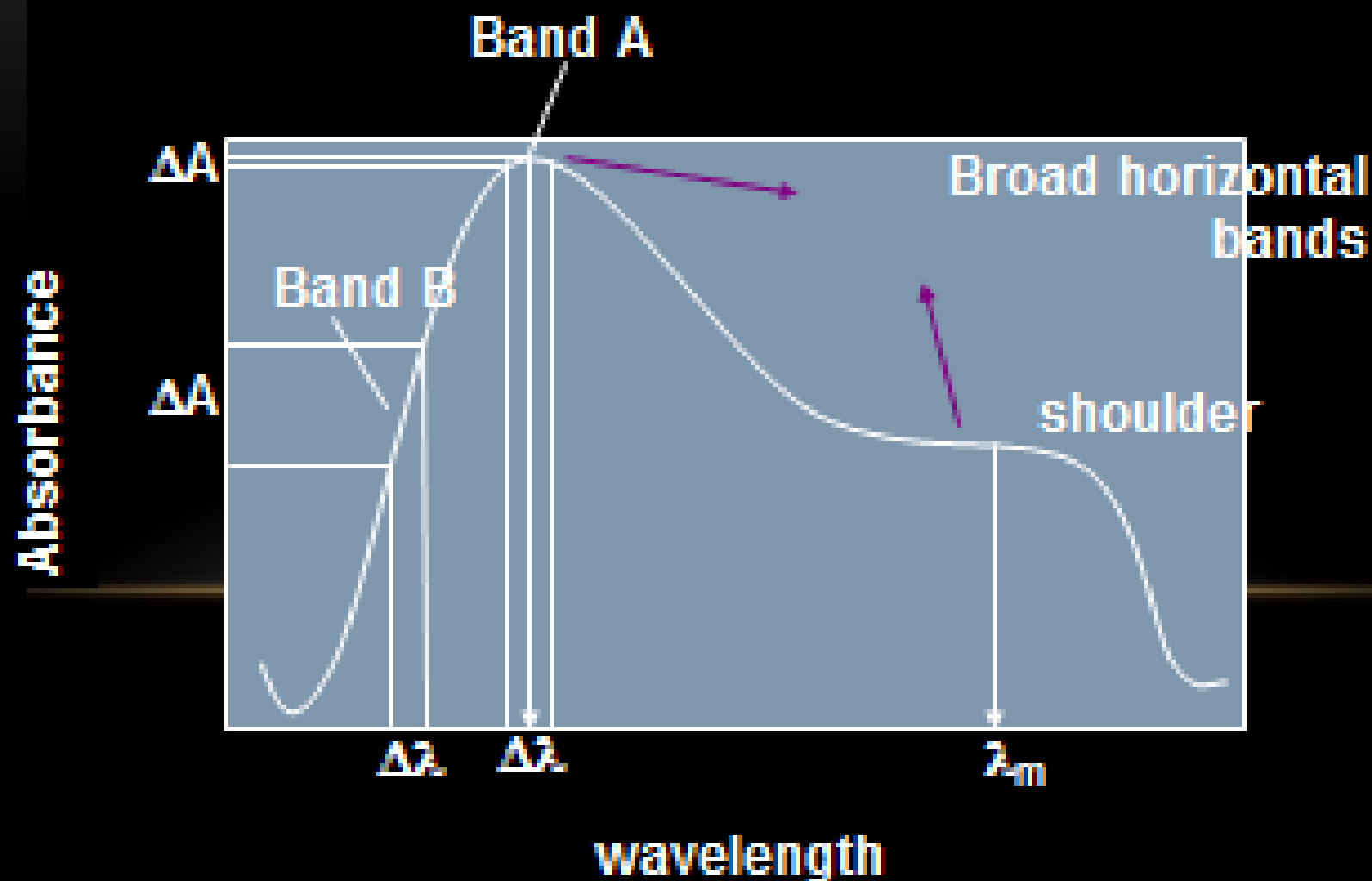

3- If the solution contains more than absorbing species, the wavelength should be chosen, whenever possible, **in region at which the other species does not absorb radiation or its absorbance is minimum.** By this way, the second species does not interfere in the determination.

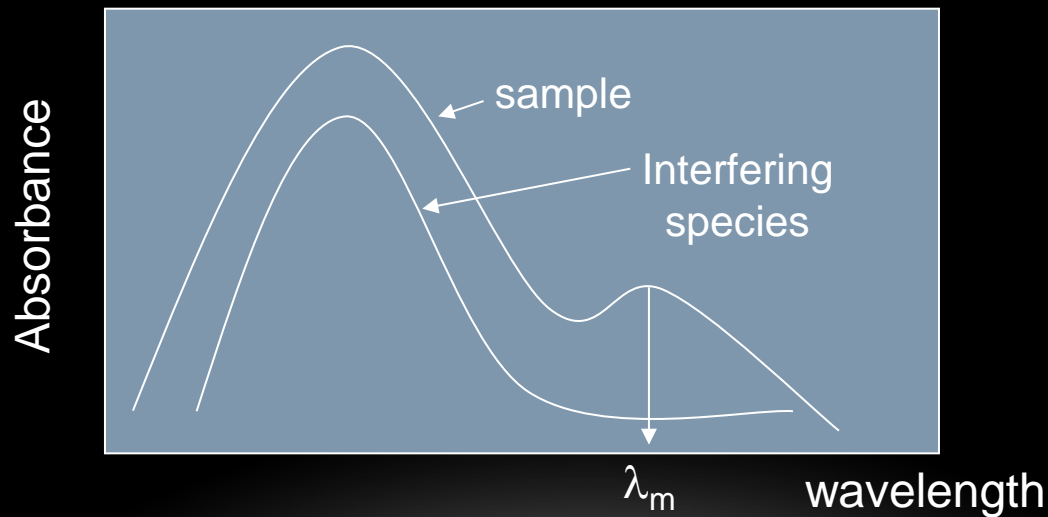

By choosing different wavelengths of light (λ_A vs. λ_B) different compounds can be measured

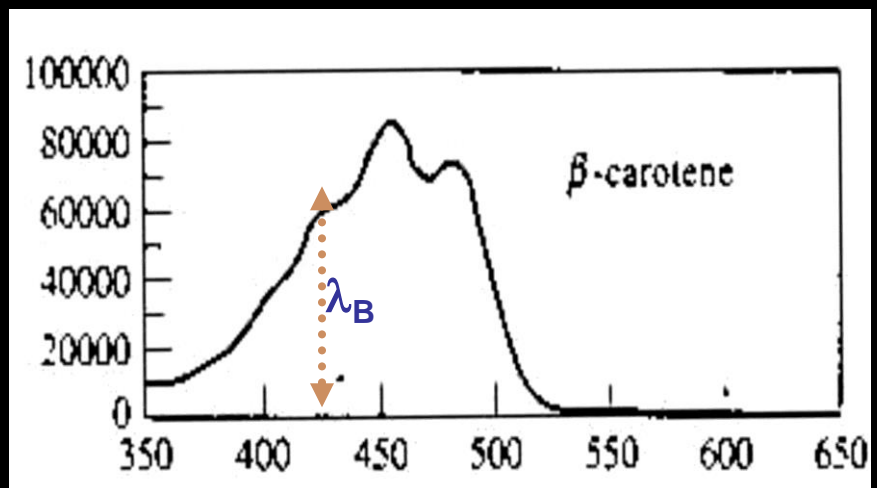
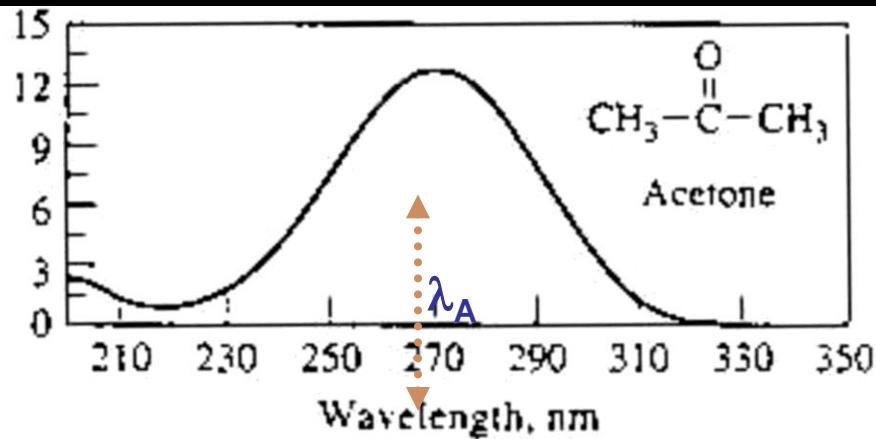

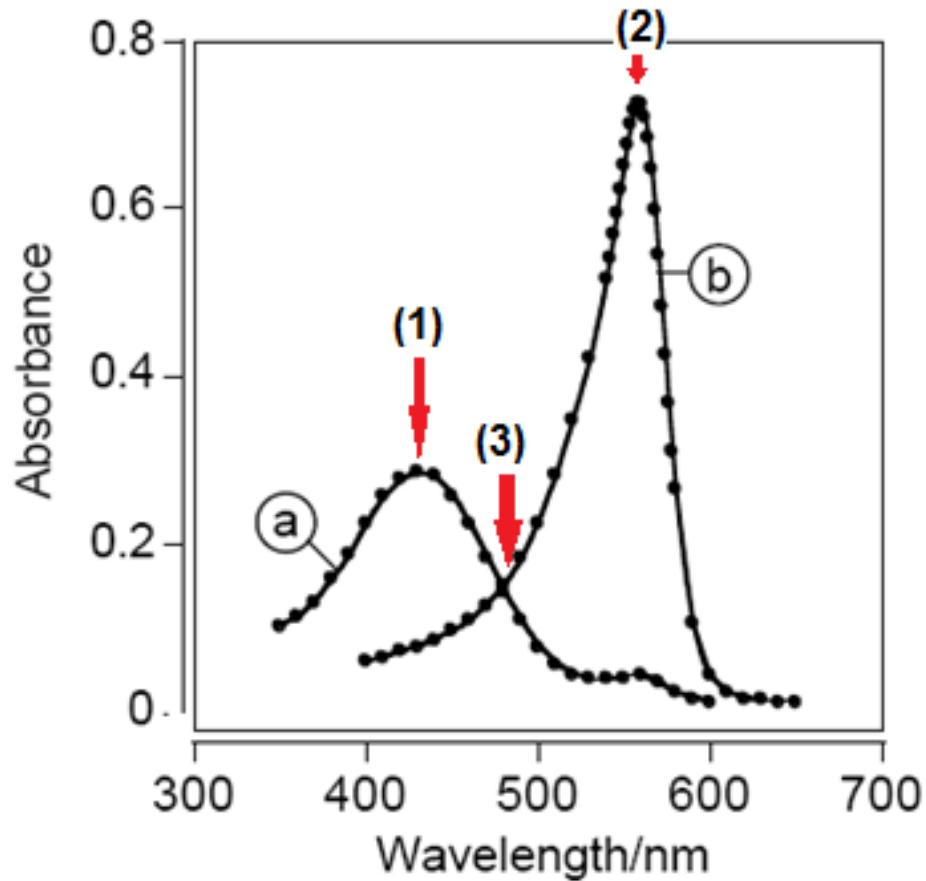

- (1) Best choice compound (a)
- (2) Best choice compound (b)
- (3) Bad choice for either compound (a) or (b)

Selection of wavelength

From the above discussion and in order to get the appropriate wavelength , the polychromatic radiation from a **source** should be separated into narrow band of wavelength (nearly monochromatic light) by a **wavelength selector (monochromator)** .

There are Various types of monochromators

based on filters (cheap)

based on prisms (limited applications)

based on gratings.... (great)

Filters

Filters permit certain bands of wavelength (bandwidth of ~ 50 nm) to pass through.

The simplest kind of filter is **absorption filters**, the most common of this type of filters is **colored glass filters**. They are used in the **visible** region. The colored glass absorbs a broad portion of the spectrum (complementary color) and transmits other portions (its color).

Incident Light

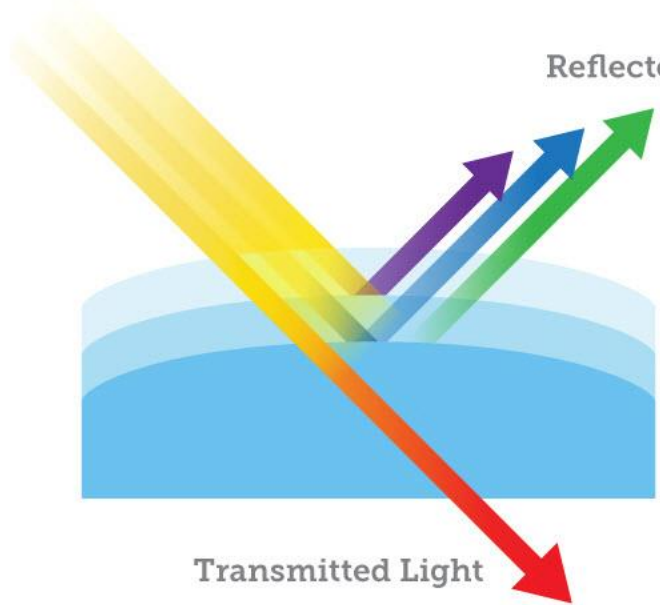

Reflected Light

Transmitted Light

Reflecting filter

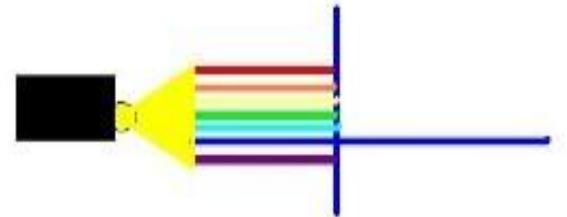
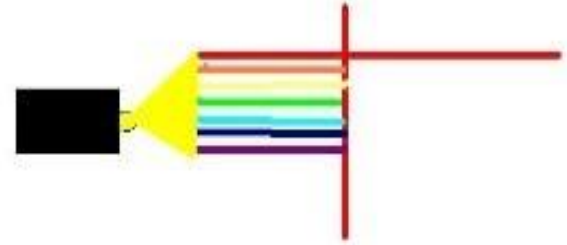

Absorbing filters

Disadvantage of filters

They are not very good wavelength selectors and can be used only in cheap instruments such as field instruments.

This is because they allow the passage of a broad bandwidth which gives a chance for deviations from Beer's law.

They absorb a significant fraction of the desired radiation

Grating monochromators

Reflection grating

Polychromatic radiation from the entrance slit is collimated (made into beam of parallel rays) by a concave mirrors

These rays fall on a reflection grating, **whereupon different wavelengths are reflected at different angles.**

The orientation of the reflection grating directs only one narrow band wavelengths, λ_2 , to the exit slit of the monochromator . Rotation of the grating allows different wavelengths, λ_1 or λ_3 , to pass through the exit slit .

A diffraction grating is a periodically structure of subsequent most evenly spaced grating lines. Those grooves or opaque lines diffract the incident light depending on, number of lines (no./cm), distance between line d and on the light's incidence angle θ_i .

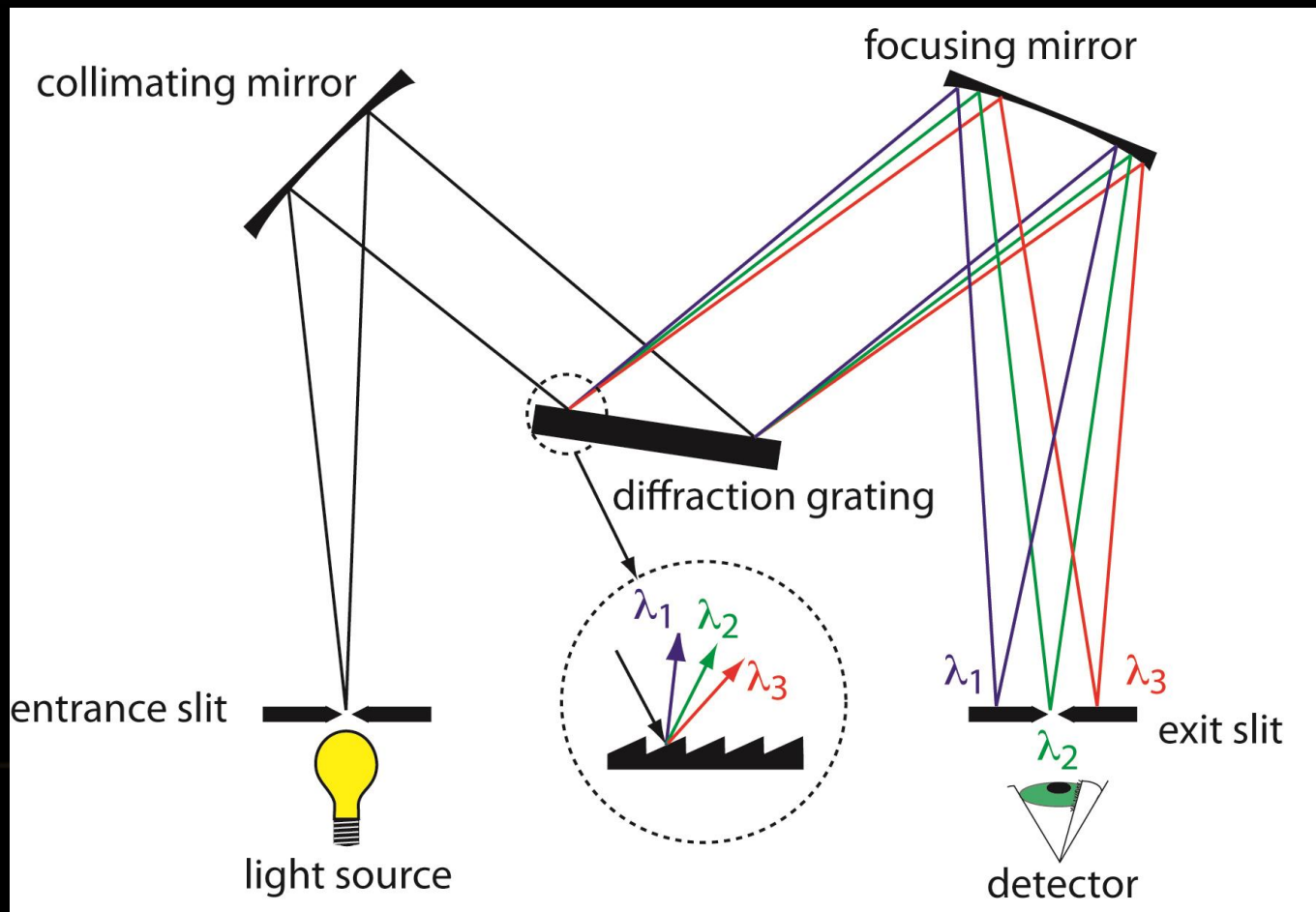

Grating equation

($n \lambda = d (\sin \theta_i + \sin \theta_r)$) where n order of radiation = 1, 2, 3,....

Since incident angle $\theta_i = \text{constant}$; therefore $\lambda \propto \theta_r$

θ_r varies with n . groove-spacing d .

For each reflection angle θ_r , a certain wavelength is observed

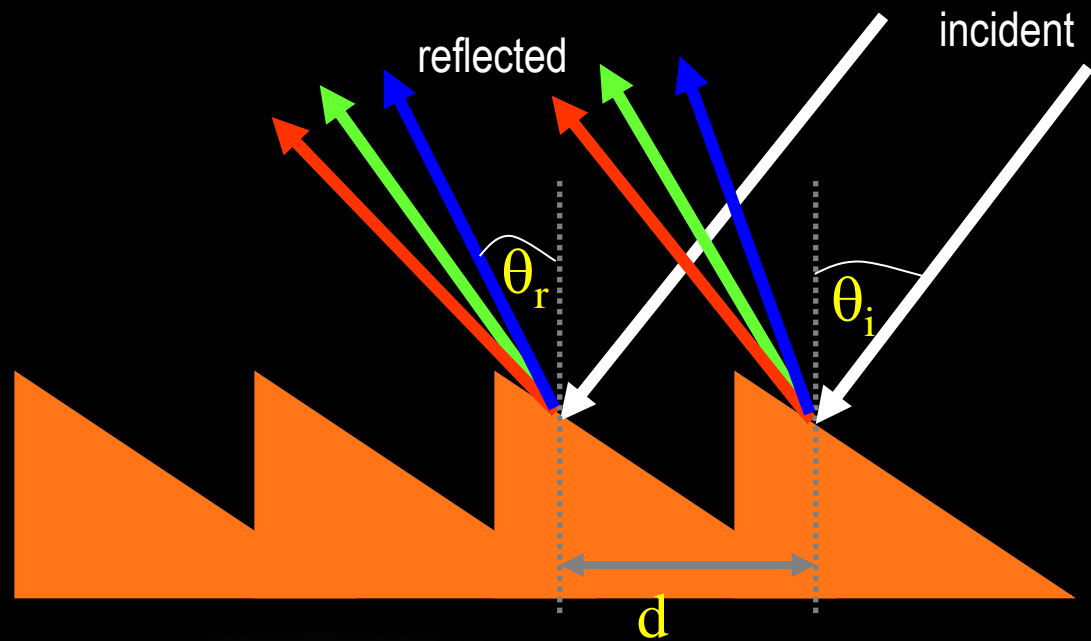
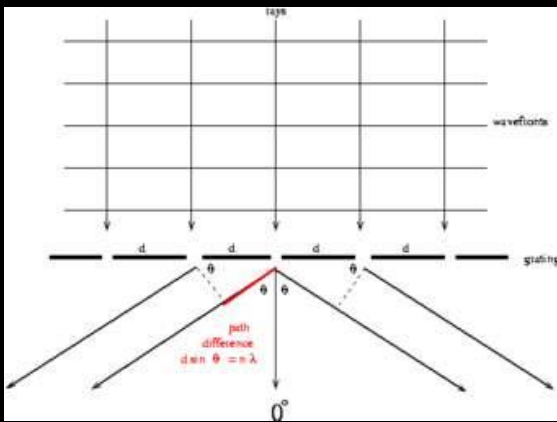

Reflection Grating

The spectral resolving power R of a grating is given by

$$R = \lambda^- / \Delta\lambda = n N$$

where n is the order and N is the number of grooves in the grating, so the objective is to maximize R , meaning we wish to maximize n and N . This is a measure of the minimum wavelength difference, $\Delta\lambda$, which can be distinguished by the grating. Its actual definition is the ratio of the average of two just distinguishable wavelengths λ^- divided by their difference $\Delta\lambda$.

Example : Calculate the resolution of a reflection grating that can separate 299 nm light from 302 nm light.

Solution : $\lambda^- = (299 + 302) / 2 = 300.5$

$R = \text{wavelength}/\text{delta wavelength} = \lambda^- / \Delta\lambda = 300.5 \text{ nm} / 3 \text{ nm} = 100.2$

Prism monochromators

Dispersion by prism depends on **refraction of light which is wavelength dependent**. Violet color with higher energy (shorter wavelength) are diffracted or bent most While red light with lower energy (longer wavelength are diffracted or bent least . As a result, the poly-chromatic white light is dispersed to its individual colors.

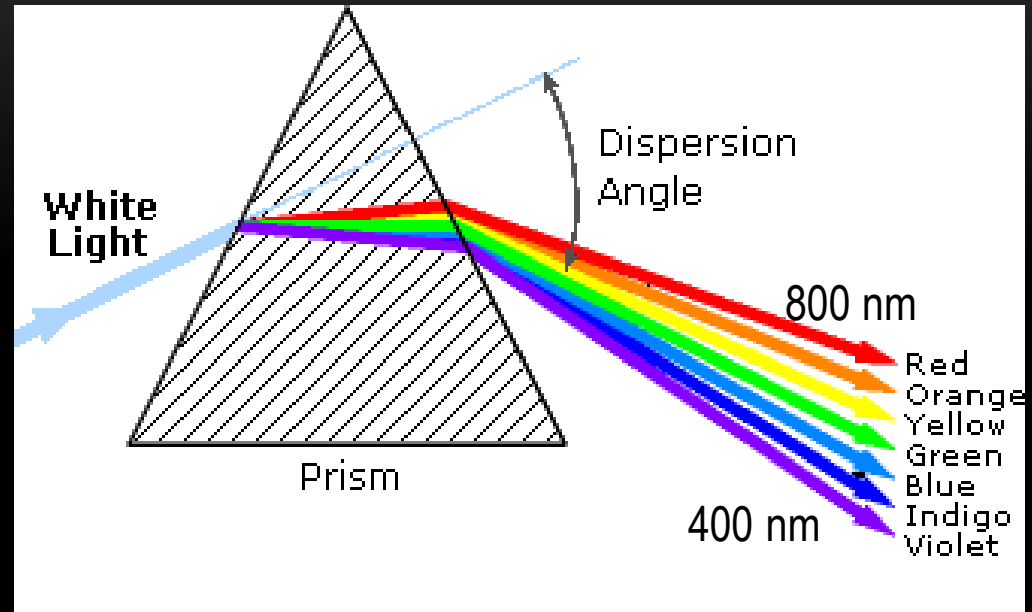

BANDWIDTH CHOICE

What are the advantages and disadvantages of decreasing monochromator slit width?

The size of the monochromator exit slit determines the width of radiation (**bandwidth**) emitted from the monochromator.

A **wider** slit width gives **higher sensitivity** because higher radiation intensity passes to the sample but on the other hand, **narrow** slit width gives **better resolution** for the spectrum i.e. less spectral interferences.

In general, the choice of slit width to use in an experiment must be made by **compromising** these two factors. Still, we can overcome the problem of low sensitivity of the small slit by **increasing the sensitivity of the detector**.

Monochromator
setting

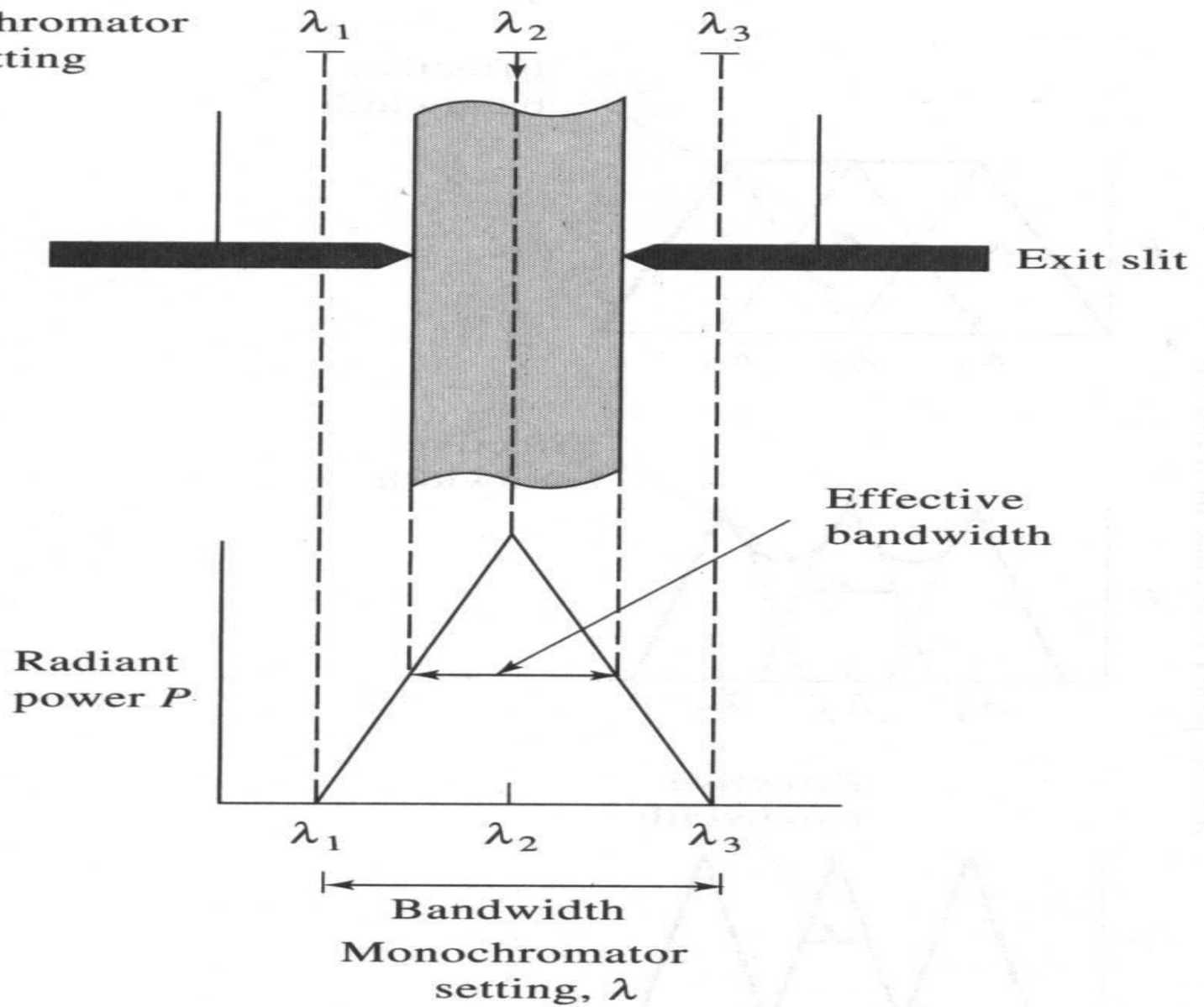

Figure 7-22 Illumination of an exit slit by monochromatic radiation λ_2 at various monochromator settings. Exit and entrance slits are identical.

Sample compartment (cells)

For Visible and UV spectroscopy, a liquid sample is usually contained in a cell called a **cuvette**.

Glass is suitable for **visible** (300 – 900 nm) but not for UV spectroscopy

because it absorbs UV radiation.

Quartz can be used in **UV** as well as in visible (200 – 3000 nm) but expensive . Must be more or less transparent to the wavelengths of light in use.

Long pathlength



1 cm pathlength cuvet



Short pathlength (b)

Detectors

The detectors are devices that convert radiant energy into electrical signal .
A Detector should be **sensitive**, and has a **fast response** over a considerable range of wavelengths.

In addition, the electrical signal produced by the detector must be **directly proportional** to the transmitted intensity (linear response).

Various types , the most common are :

Photographic films (not widely in use any more)

Phototubes (used in simpler instruments)

Photomultiplier tubes (used in more complex instruments)

Phototube

Phototube emits electrons from a **photosensitive, negatively charged cathode** when struck by visible or UV radiation. The electrons flow through vacuum to **an anode** to produce current which is proportional to radiation intensity.

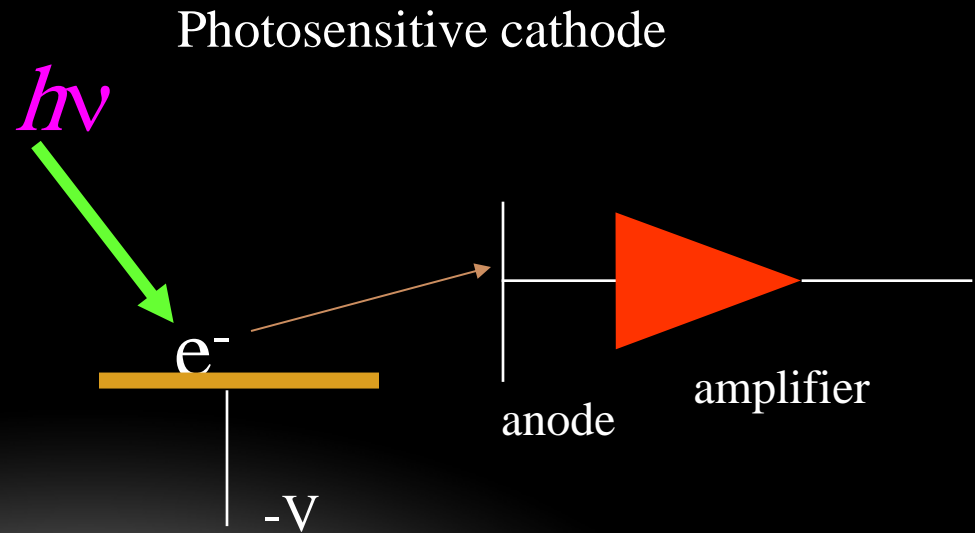

Photomultiplier tube

electrons emitted from the photosensitive cathode due to striking radiation strike a second surface called **dynode**.

Electrons are thus accelerated and can knock out more than one electrons from the dynode. If the above process is repeated several times, so more than 10^6 electrons are finally collected for each photon striking the first cathode.

Photomultiplier tube

Process:

- a) light hits photosensitive cathode and e^- is emitted.
- b) an emitted e^- is attracted to electrode (dynode 1). Causes several more e^- to be emitted.
- c) these e^- are attracted to dynode 2, emitting more e^- .
- d) process continues until e^- are collected at anode after amplification at 9 dynodes.
- e) one photon produces $10^6 - 10^7$ electrons.
- f) current is amplified and measured.

There are various types of photomultiplier tubes .

Photomultiplier tube

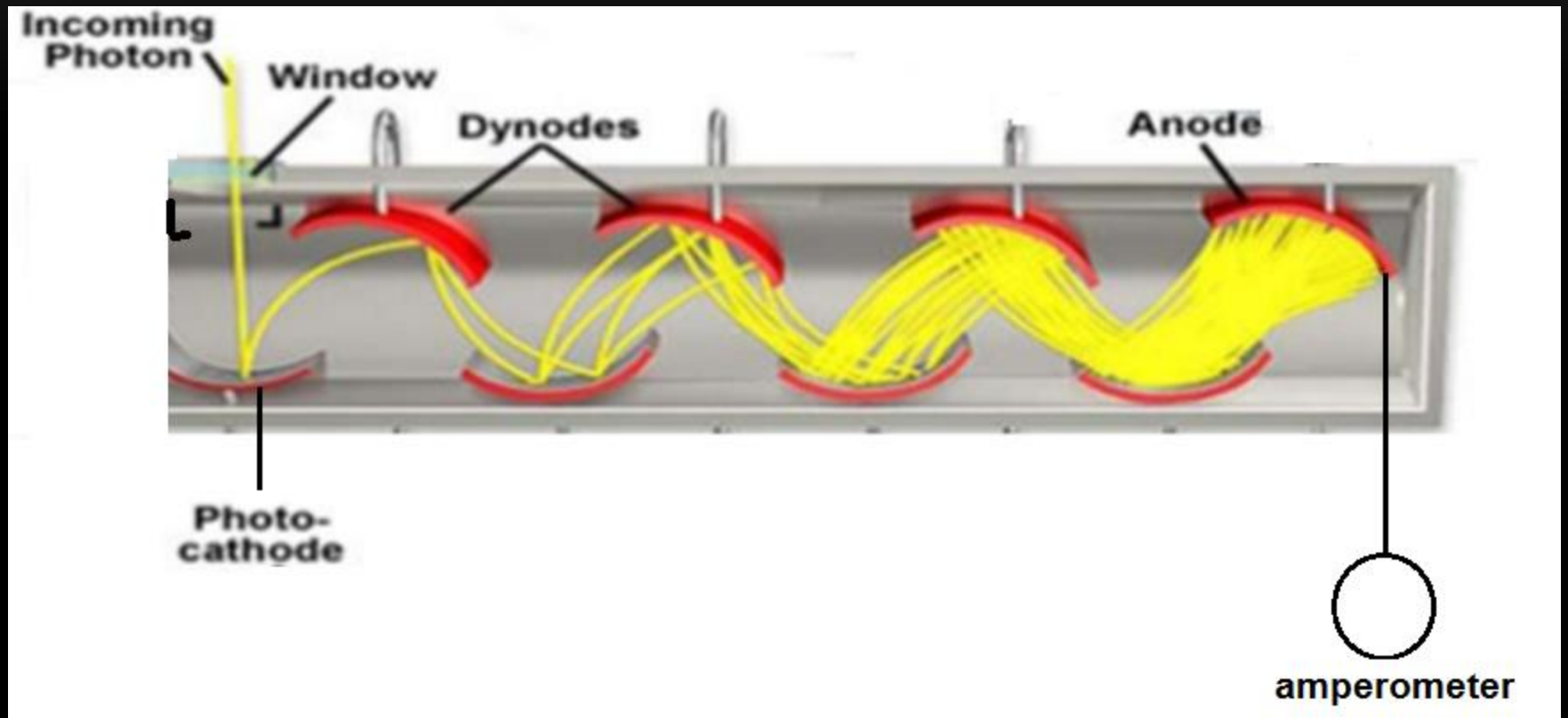

Photomultiplier tube

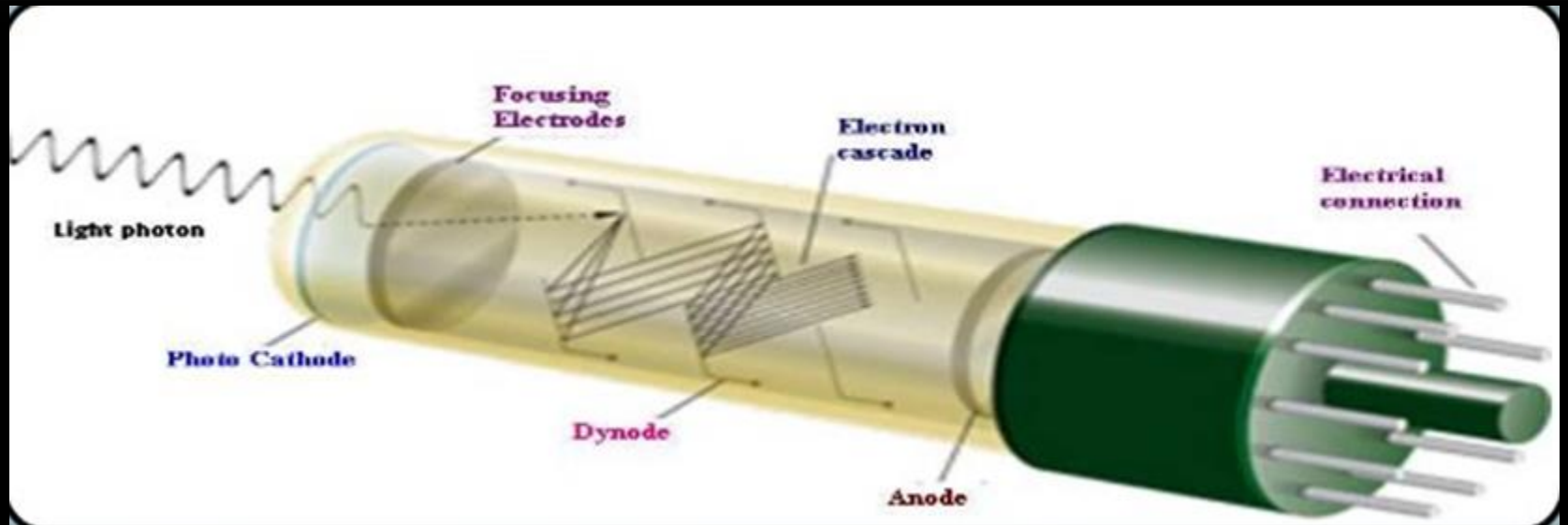

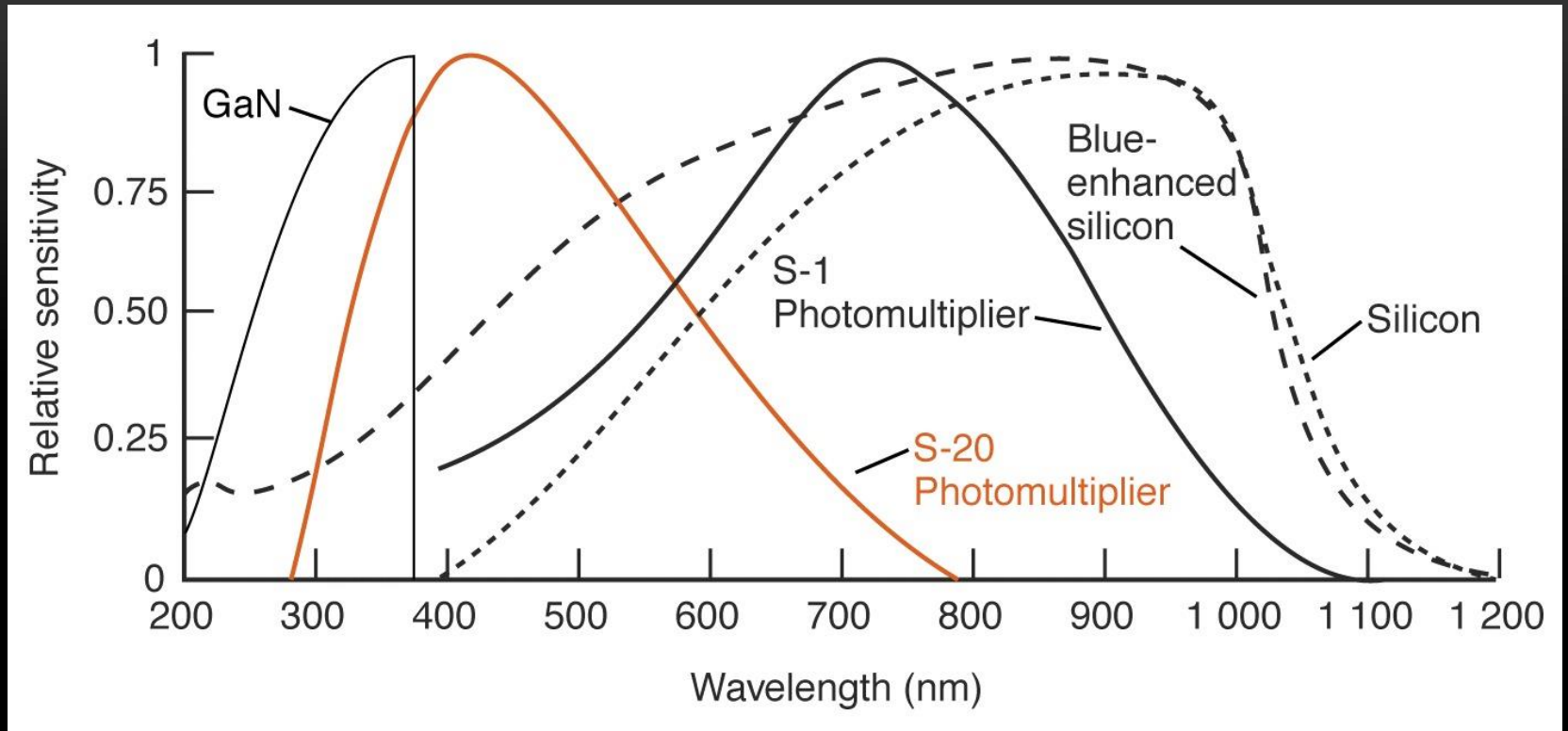

- Detector response depends on the λ of the incident photons
- **Different wavelengths require different detectors.**

The components of a single beam spectrophotometer

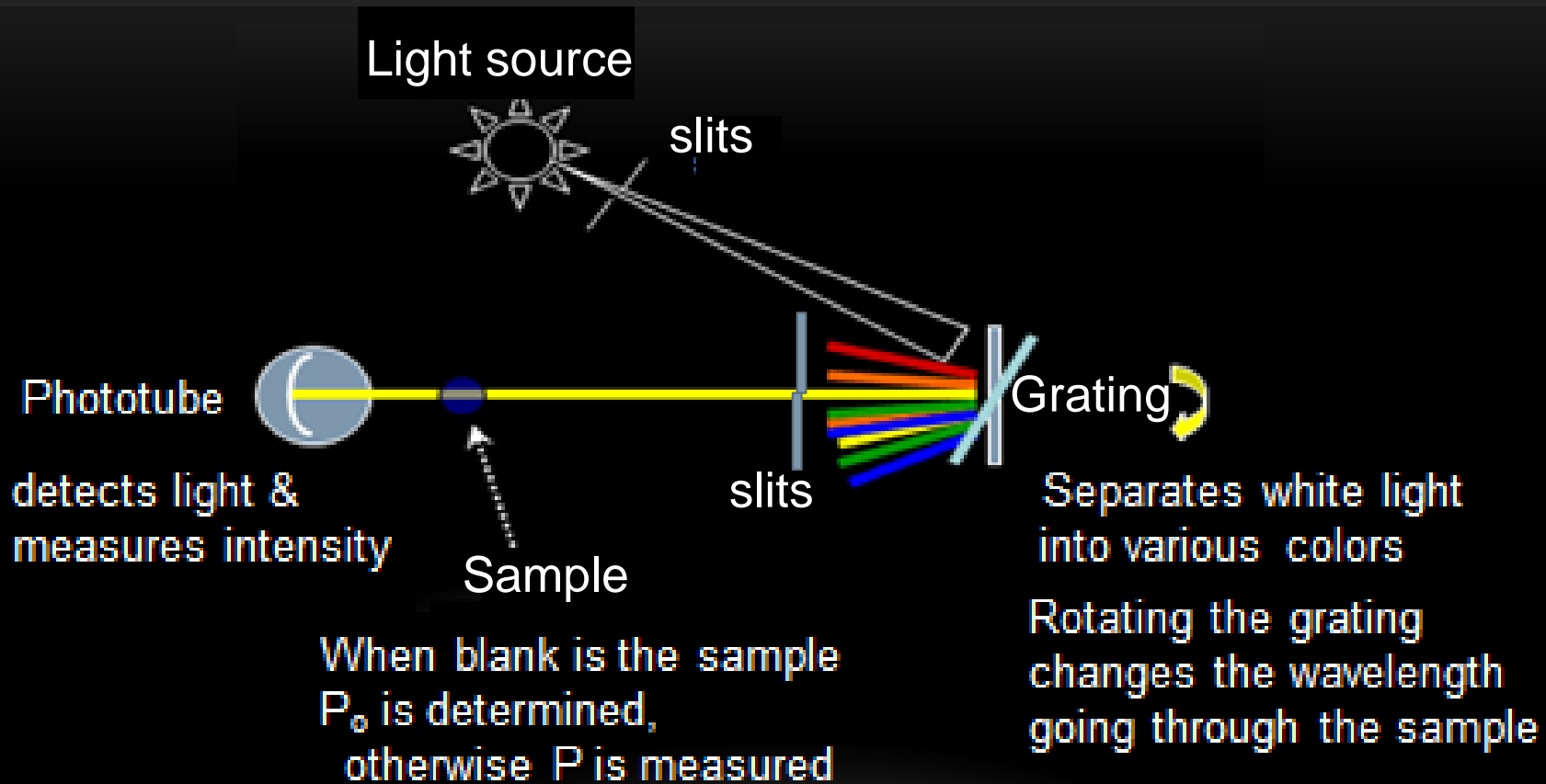

DOUBLE BEAM SPECTROPHOTOMETER

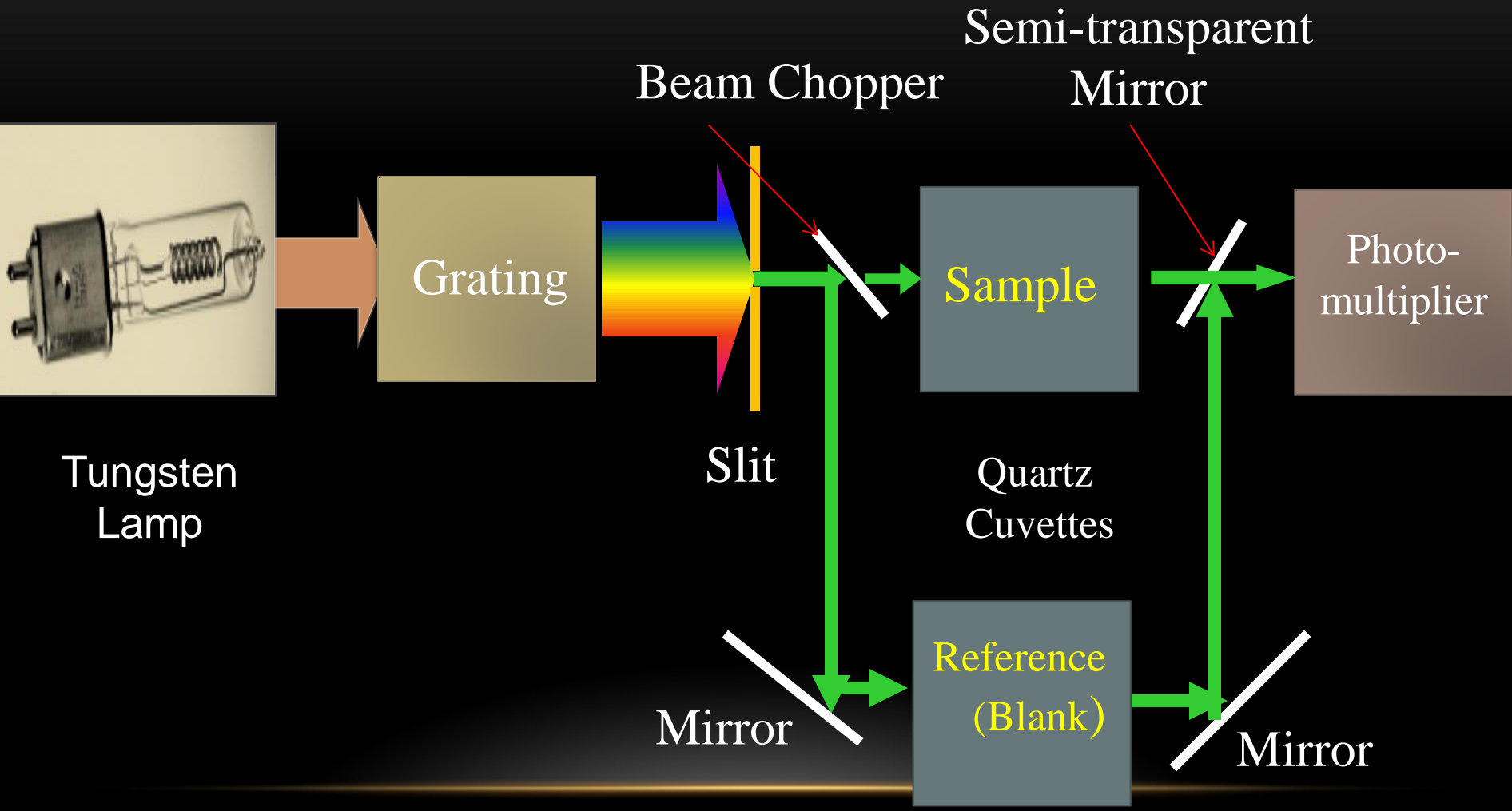

Spectrophotometer :

a) Single-beam

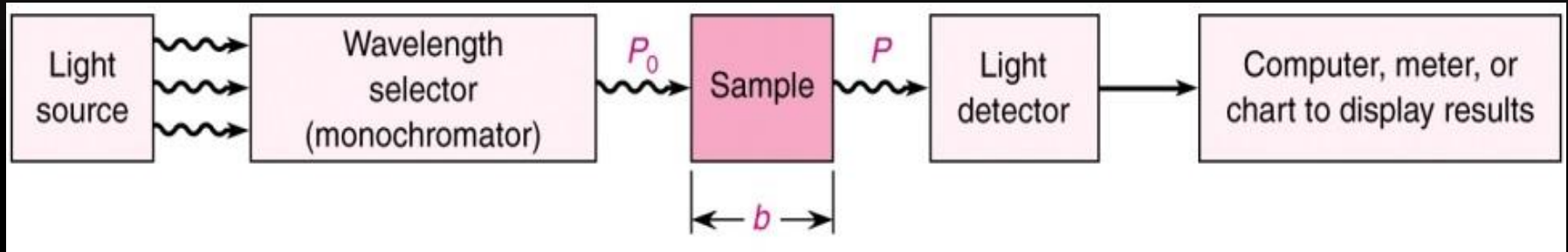

b) Double-beam

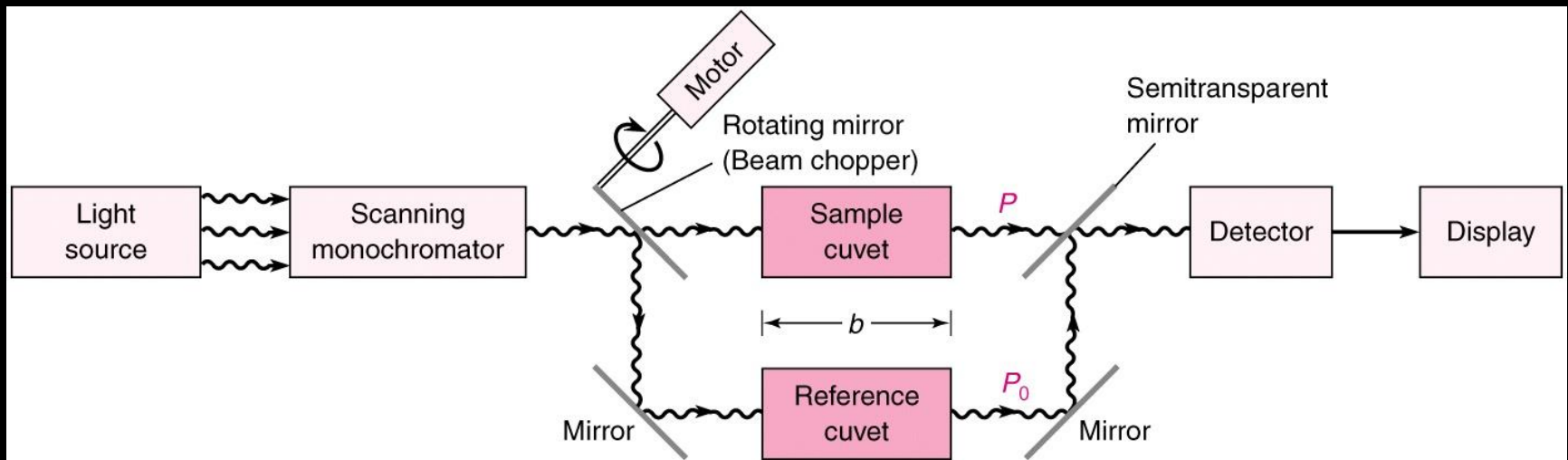

In double beam arrangement, the light alternately passes through **the sample and reference** (blank), directed by rotating half-sector mirror (chopper) into and out of the light path.

When light passes through the sample, the detector measures the **P**. When the chopper diverts the beam through the blank solution, the detector measures **P_0** .

The beam is chopped several times per second and the electronic circuit automatically compares **P and P_0** to calculate absorbance and Transmittance.

Advantages of double beam over single beam instrument

Single beam spectrophotometer is inconvenient because the sample and blank must be placed alternately in the light path. For measurements at multiple wavelengths, the blank must be run at each wavelength.

While in double beam, the absorption in the sample is automatically corrected for the absorption occurring in the blank, since the readout of the instrument is log the difference between the sample beam and the blank beam.

Small changes in P have no effect in double beam but may have great effect with single beam. Why ?

.....Cont'd

In double beam instruments, automatic correction for changes of the source intensity and changes in the detector response with time or wavelength because the two beams are compared and measured at the same time . In double beam we can make automatic scanning and continuous recording of spectrum (absorbance versus wavelength) which we can not with single beam .

على الراغبين الاستماع الى محاضرة عن موضوع هذه
الوحدة باللغة العربية الضغط على كل من الروابط التالية :

[Part 6 : Spectrometric Instrumentation](#)

[Part 7 : Spectrometric Instrumentation](#)

[Part 8 : Spectrometric Instrumentation](#)

[Part 9 : Spectrometric Instrumentation](#)