

# Chemical Separation and Chromatographic Methods

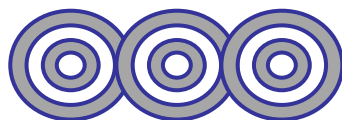
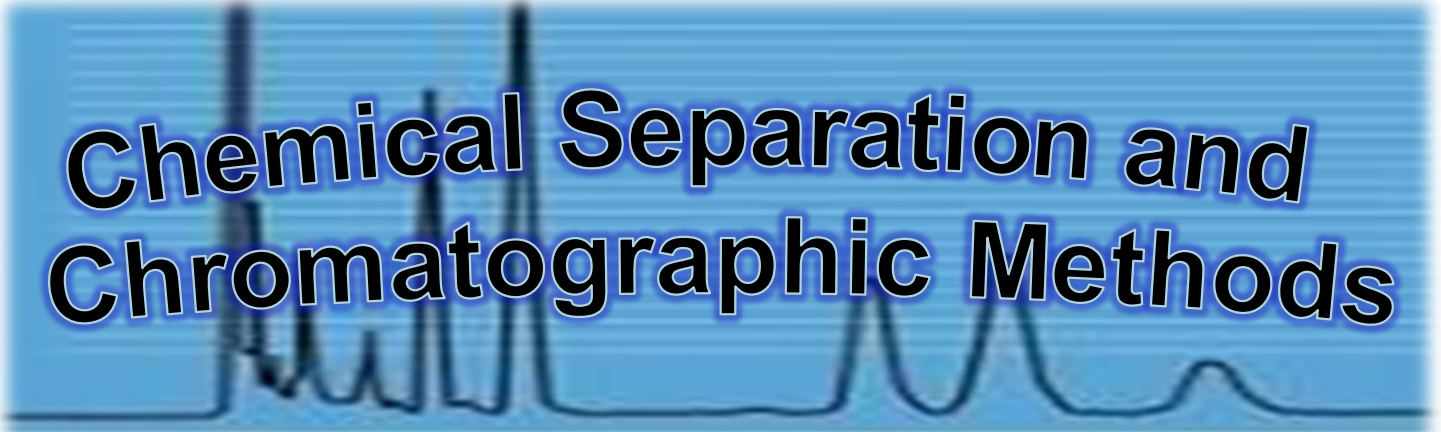

## High Performance Liquid Chromatography (HPLC)

**Ahmad Aqel Ifseisi**

Assistant Professor of Analytical Chemistry  
College of Science, Department of Chemistry  
King Saud University

P.O. Box 2455 Riyadh 11451 Saudi Arabia

Building: 05, Office: 1A7 & AA53

Tel. 014674198, Fax: 014675992

Web site: <http://fac.ksu.edu.sa/aifseisi>

E-mail: [ahmad3qel@yahoo.com](mailto:ahmad3qel@yahoo.com)

[aifseisi@ksu.edu.sa](mailto:aifseisi@ksu.edu.sa)



كرسي أبحاث  
المواد المتقدمة  
Advanced Materials  
Research Chair



جامعة  
الملك سعود  
King Saud University



# Principles of liquid chromatography

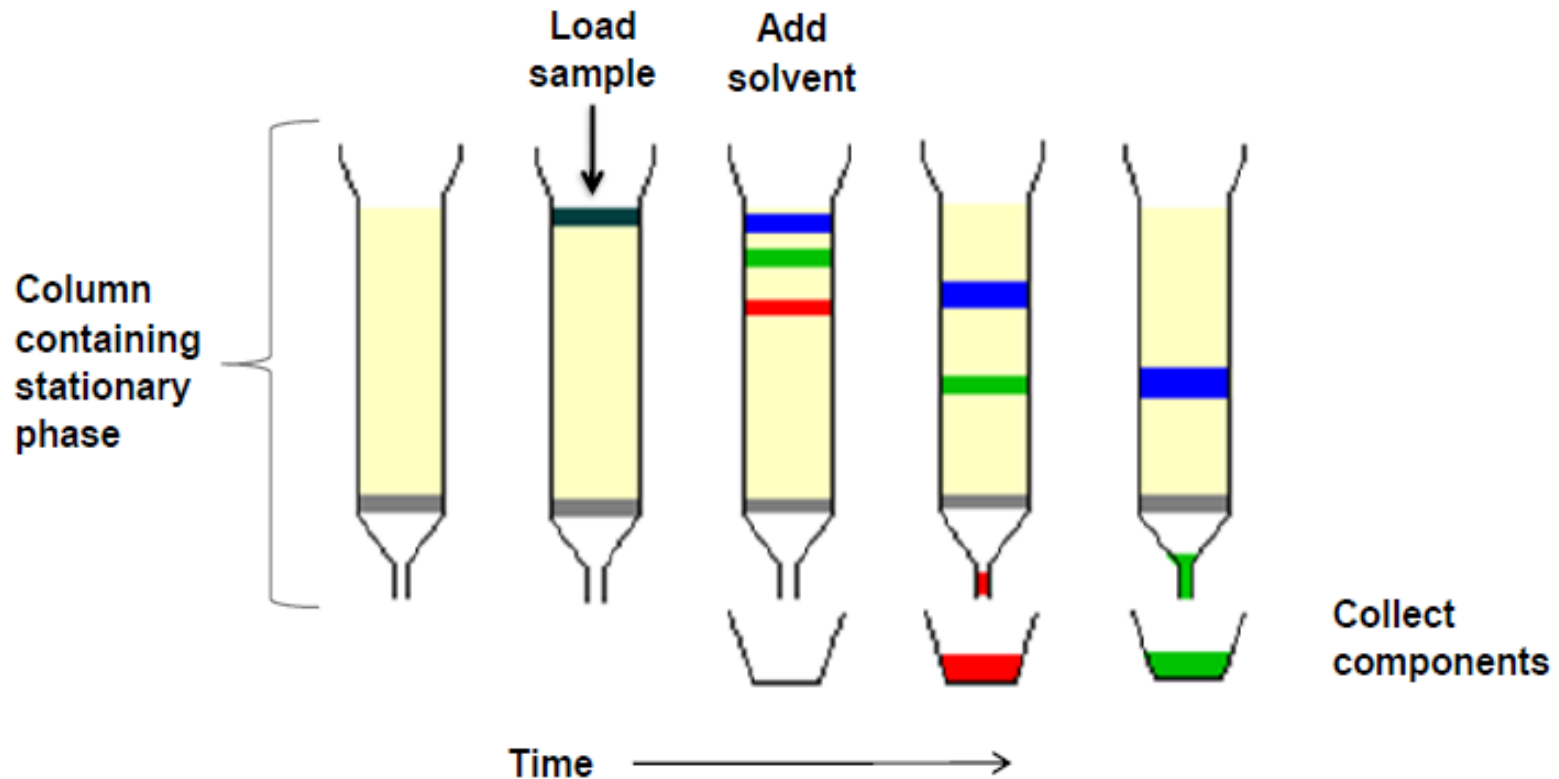

The components of the sample are separated from one another by the column packing that involves various chemical and/or physical interactions between their molecules and the packing particles.

The separated components are collected at the exit of this column and identified by an external measurement technique.

# Impetus behind high pressure

Early LC, including the original work by **Tswett**, was carried out in glass columns with diameter of 1–5 cm and lengths of 50–500 cm and 150–200  $\mu\text{m}$  stationary phase particle diameter.

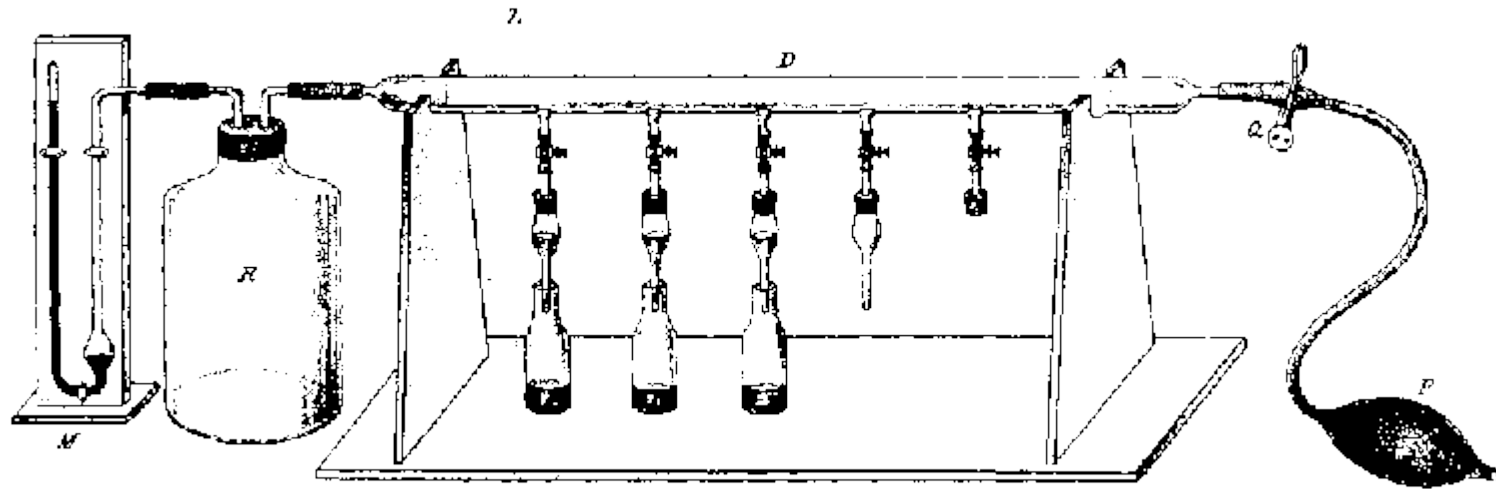

Tswett's apparatus

Scientists realized that the major increases in column efficiency could be brought about by decreasing the particle size of packings, this required sophisticated instruments with high pressure pumps to assure reasonable flow rate.

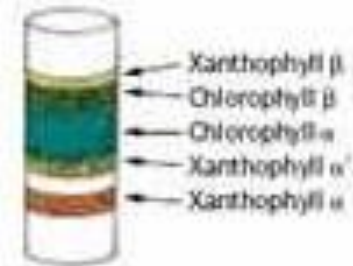

# Overview of HPLC

Since its advent in 1974 by Horvath, HPLC has expanded very quickly.

HPLC is an abbreviation for **High Performance** Liquid Chromatography (It has also been referred to as **High Pressure** LC)

HPLC is a type of LC in which the mobile phase is liquid that forced through a reusable column by means of a pumping system, use to separate compounds that are dissolved in solution.

HPLC is very efficient technique and can be applied to about every kind of sample; it yields excellent separations in a short time, and can work with minimal training of the operator. Today, HPLC is one the most widely used techniques for separating and analyzing mixtures of chemical substances, compounds and materials.

# HPLC versus GC

LC is a much older technique than GC, but was overshadowed by the rapid development of GC in the 1950's and 1960's.

LC is currently the dominate type of chromatography and is even replacing GC in its more traditional applications.

## ***Advantages of LC compared to GC:***

- LC can be applied to the separation of any compound that is soluble in a liquid phase. LC more useful in the separation of biological compounds, synthetic or natural polymers and inorganic compounds such materials include amino acids, proteins, nucleic acids, drugs, steroids, terpenoids, pesticides, antibiotics and metal-organic species.
- LC is suitable for separating nonvolatile compounds
- Liquid mobile phase allows LC to be used at lower temperatures than required by GC. LC better suited than GC for separating compounds that may be thermally labile.
- Retention of solutes in LC depend on their interaction with both the mobile phase and stationary phase. GC retention based on volatility and interaction with stationary phase. LC is more flexible in optimizing separations → change either stationary or mobile phase.
- Most LC detectors are non-destructive. Most GC detectors are destructive. LC is better suited for preparative or process-scale separations.

## ***Disadvantage of LC compared to GC:***

LC is subject to greater peak or band-broadening. RESOLUTION !!!!  
much larger diffusion coefficients of solutes in gases vs. liquids.

# Separation mechanisms and LC modes

A useful classification of the various LC techniques is based on the type of distribution mechanism applied in the separation. Individual HPLC columns may use any one of a number of different phases or processes to induce this resolution.

A variety of chromatographic modes have been developed, on the basis of the mechanisms of retention and operation, which consider as the more common classification. This classification scheme stems from the manner in which the analyte interacts with the stationary phase.

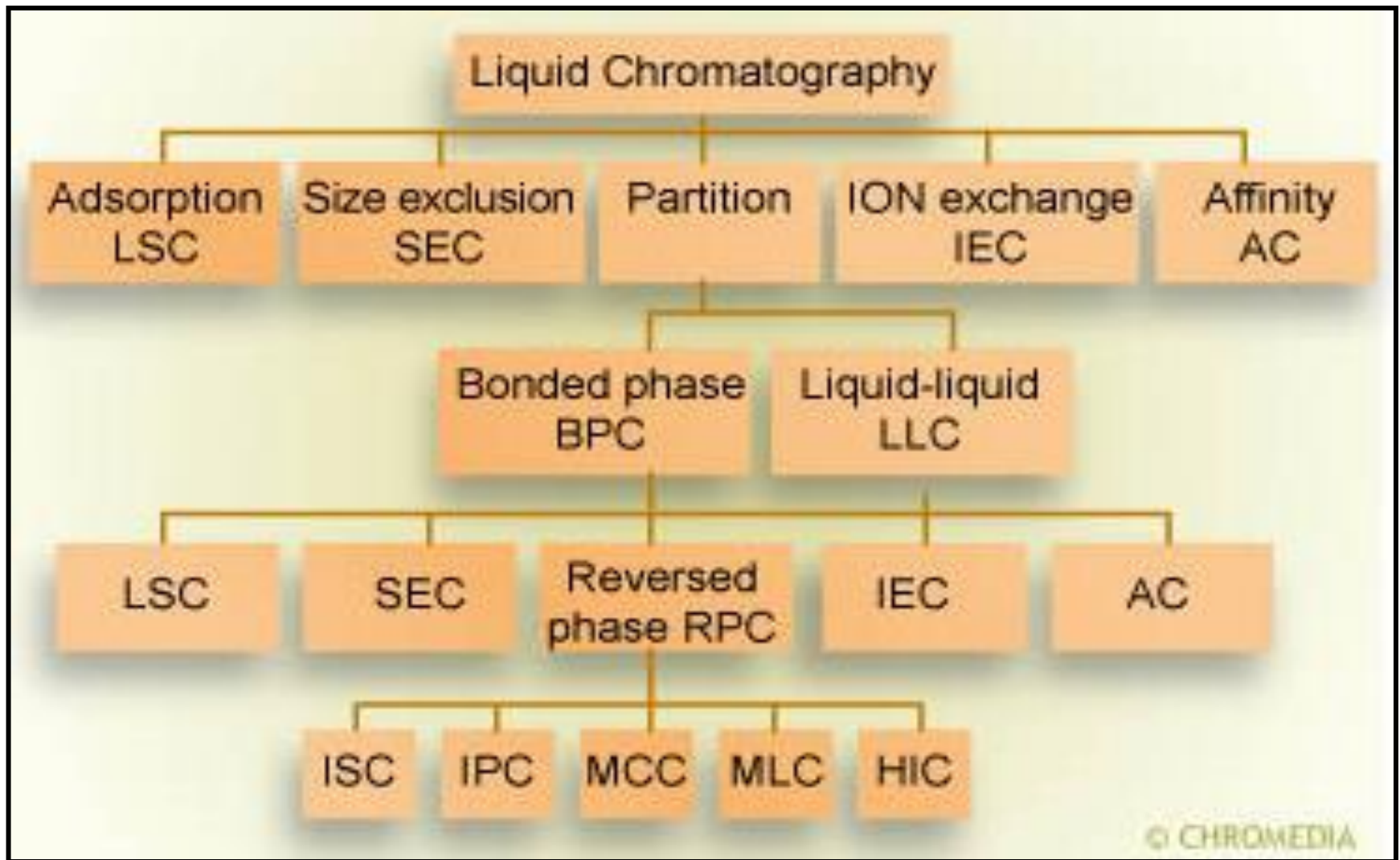

### Modes of **HPLC** separation.

LSC: Liquid solid chromatography. SEC: Size exclusion chromatography. IEC: Ion exchange chromatography. AC: Affinity chromatography. BPC: Bonded phase chromatography. LLC: Liquid Liquid chromatography. RPC: Reversed phase chromatography. ISC: Ion suppression chromatography. IPC: Ion pair chromatography. MCC: Metal complexation chromatography. MLC: Micellar liquid chromatography. HIC: Hydrophobic interaction chromatography.



In practice, most LC separations are the result of mixed mechanisms, e.g., in partition chromatography, in most cases contributions due to adsorption/desorption effects are observed.

Most LC applications (about 80%) are done with reversed phase LC, i.e., a nonpolar stationary phase and a polar mobile phase. Reversed phase LC is ideally suited for the analysis of polar and ionic analytes, which are not amenable to GC analysis.

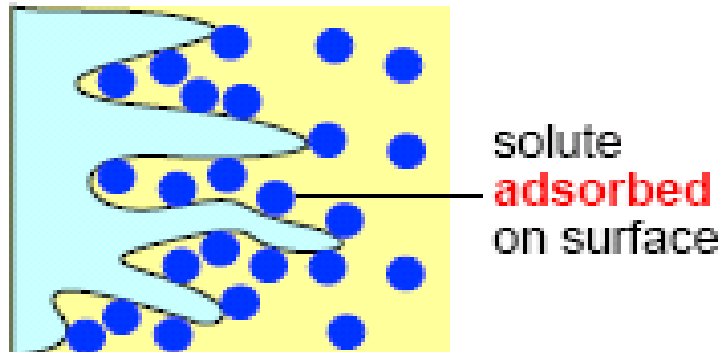

Adsorption Chromatography

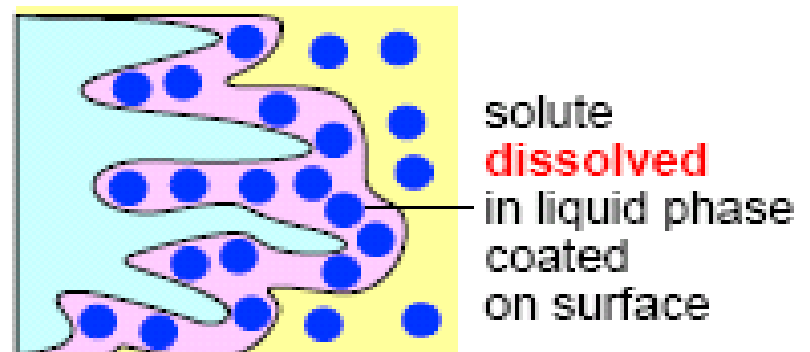

Partition Chromatography

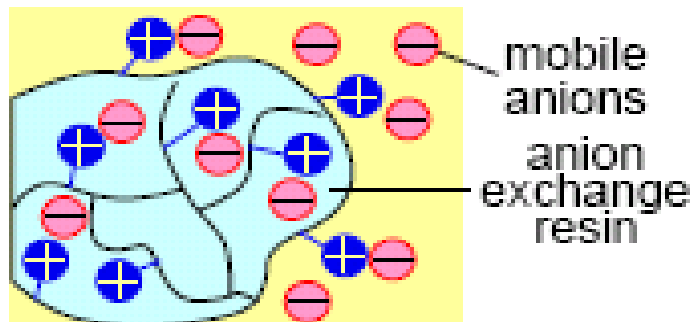

Ion-Exchange Chromatography

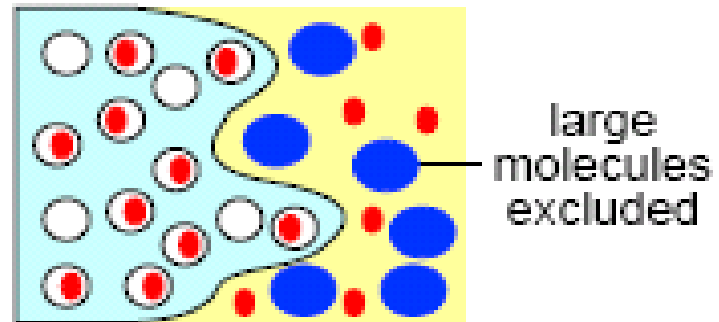

Molecular Exclusion Chromatography

Gel Permeation Chromatography

Gel-Filtration Chromatography

Gel Chromatography

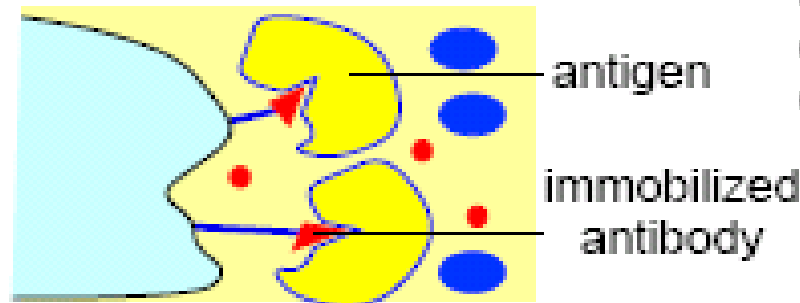

Affinity Chromatography

Normal-phase chromatography

Low polarity mobile phase

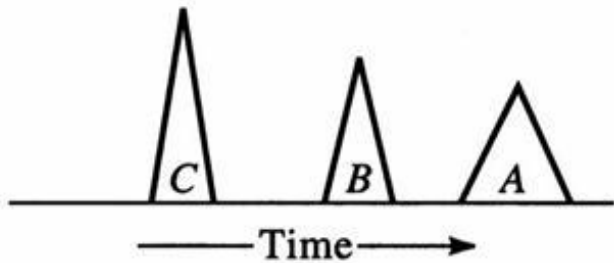

Reversed-phase chromatography

High polarity mobile phase

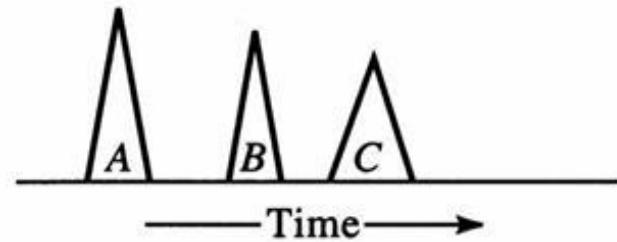

Medium polarity mobile phase

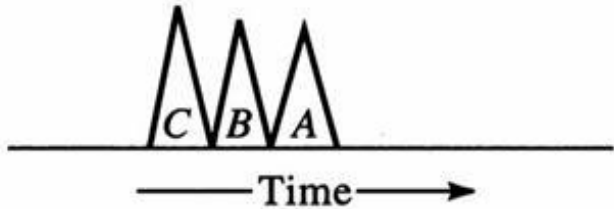

Medium polarity mobile phase

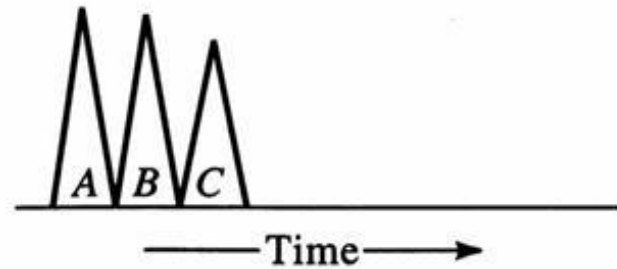

Solute polarities:  $A > B > C$

The relationship between polarity and elution times for normal phase and reversed phase chromatography

# Properties of common chromatographic mobile phases

Solvent	Refractive Index <sup>a</sup>	Viscosity, cP <sup>b</sup>	Boiling Point, °C	Polarity Index, <i>P'</i>	Eluent Strength, <sup>c</sup> $\epsilon^0$
Fluoroalkanes <sup>d</sup>	1.27–1.29	0.4–2.6	50–174	<–2	–0.25
Cyclohexane	1.423	0.90	81	0.04	–0.2
<i>n</i> -Hexane	1.372	0.30	69	0.1	0.01
1-Chlorobutane	1.400	0.42	78	1.0	0.26
Carbon tetrachloride	1.457	0.90	77	1.6	0.18
<i>i</i> -Propyl ether	1.365	0.38	68	2.4	0.28
Toluene	1.494	0.55	110	2.4	0.29
Diethyl ether	1.350	0.24	35	2.8	0.38
Tetrahydrofuran	1.405	0.46	66	4.0	0.57
Chloroform	1.443	0.53	61	4.1	0.40
Ethanol	1.359	1.08	78	4.3	0.88
Ethyl acetate	1.370	0.43	77	4.4	0.58
Dioxane	1.420	1.2	101	4.8	0.56
Methanol	1.326	0.54	65	5.1	0.95
Acetonitrile	1.341	0.34	82	5.8	0.65
Nitromethane	1.380	0.61	101	6.0	0.64
Ethylene glycol	1.431	16.5	182	6.9	1.11
Water	1.333	0.89	100	10.2	Large

# Optimization of mobile phase polarity ...

Changing the mobile phase composition alters the separation.

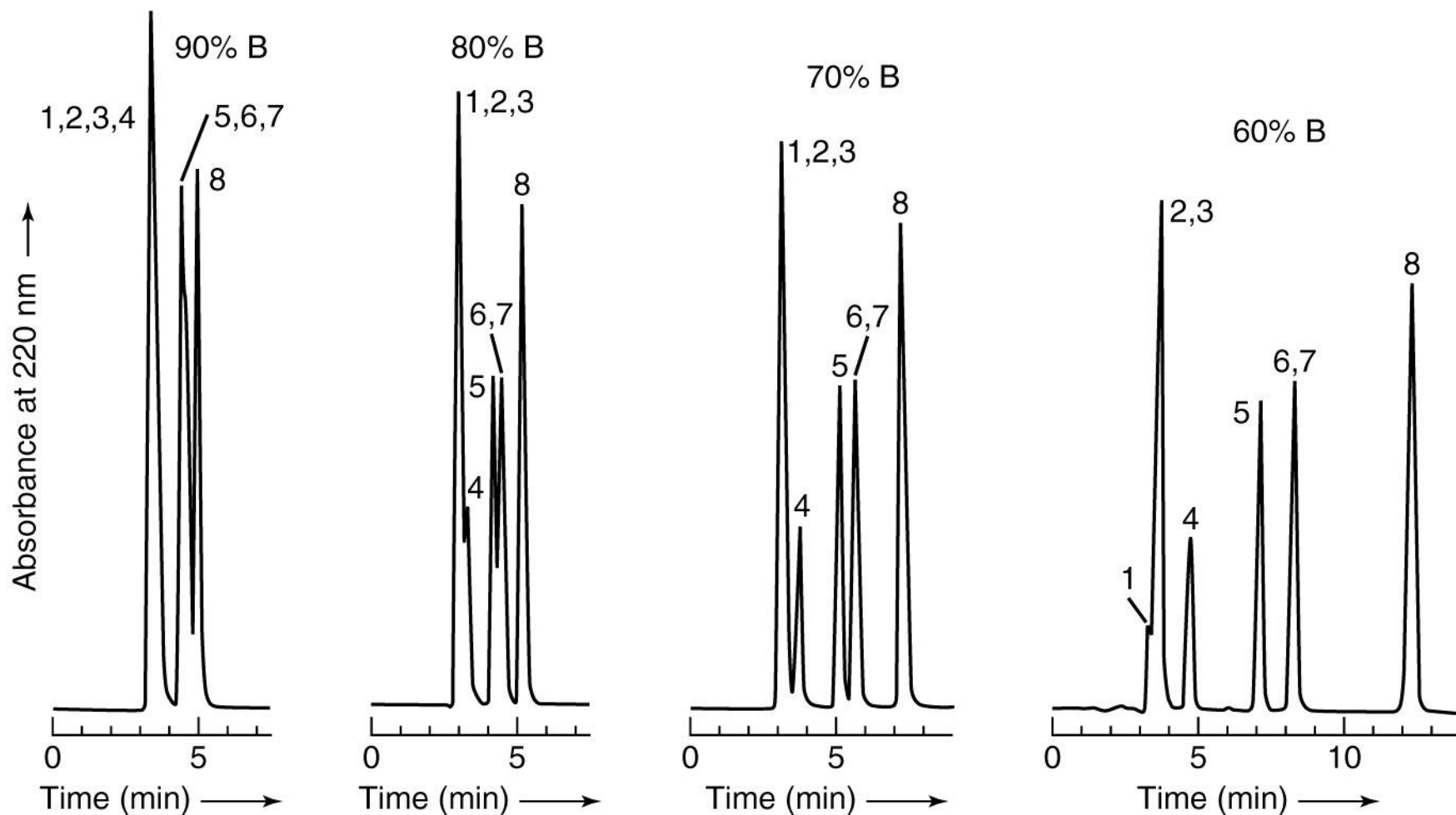

# HPLC system

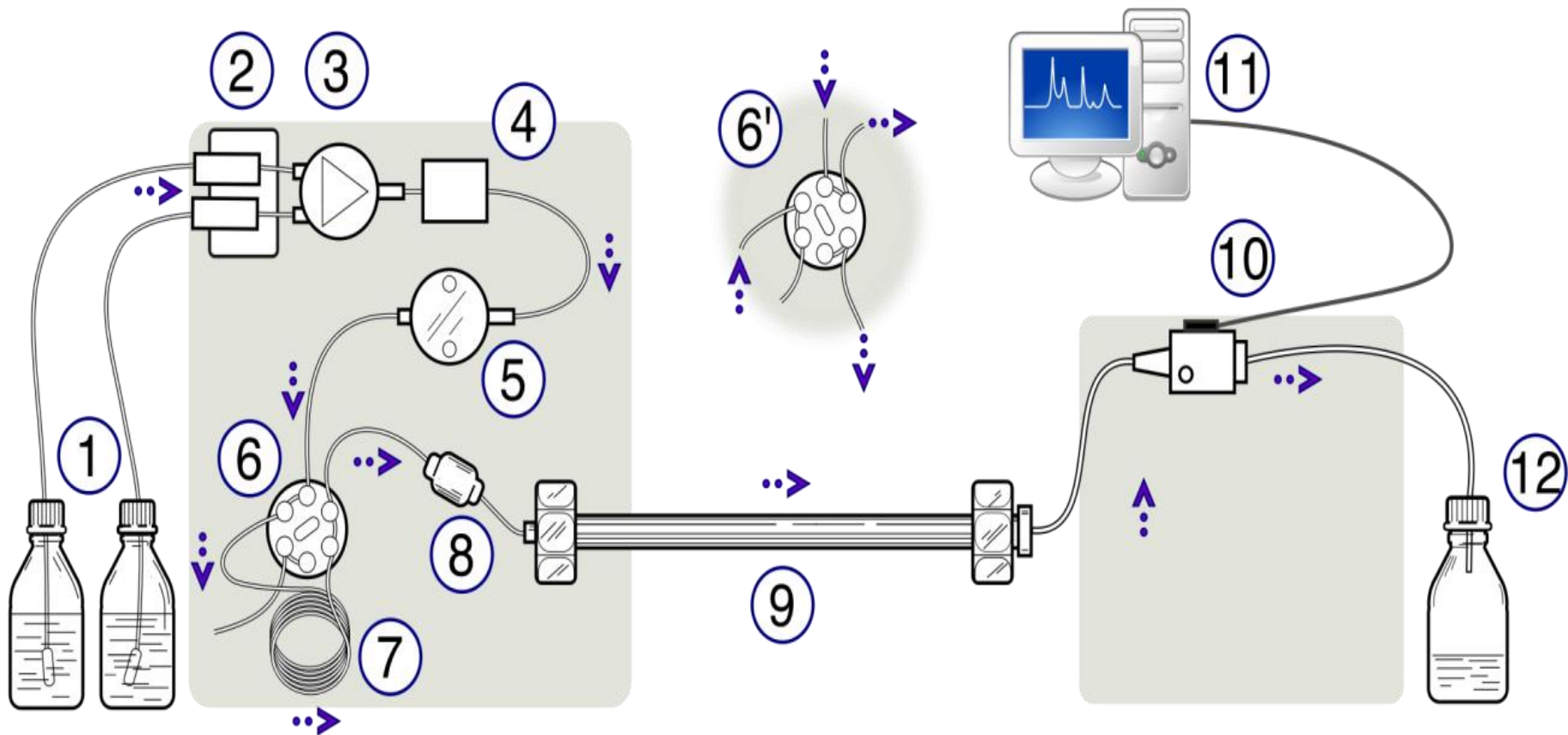

## Schematic of an HPLC system

1= Mobile phase reservoir, 2= Solvent degasser, 3= Gradient valve, 4= Mixing vessel, 5= Solvent delivery system (or a pump), 6= Switching valve in inject position, 6'= Switching valve in load position, 7= Sample introduction device (or the injector), 8= Pre-column (guard column), 9= Analytical column (a separation column that contains the stationary phase on which the separation is to be performed), 10= Detector (one or more detectors), 11= Data acquisition or read out, 12= Waste or fraction collector.

Mobile Phase



Pump



Sample



Column  
Stationary phase

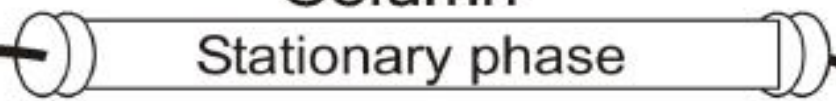

Detector



Computer

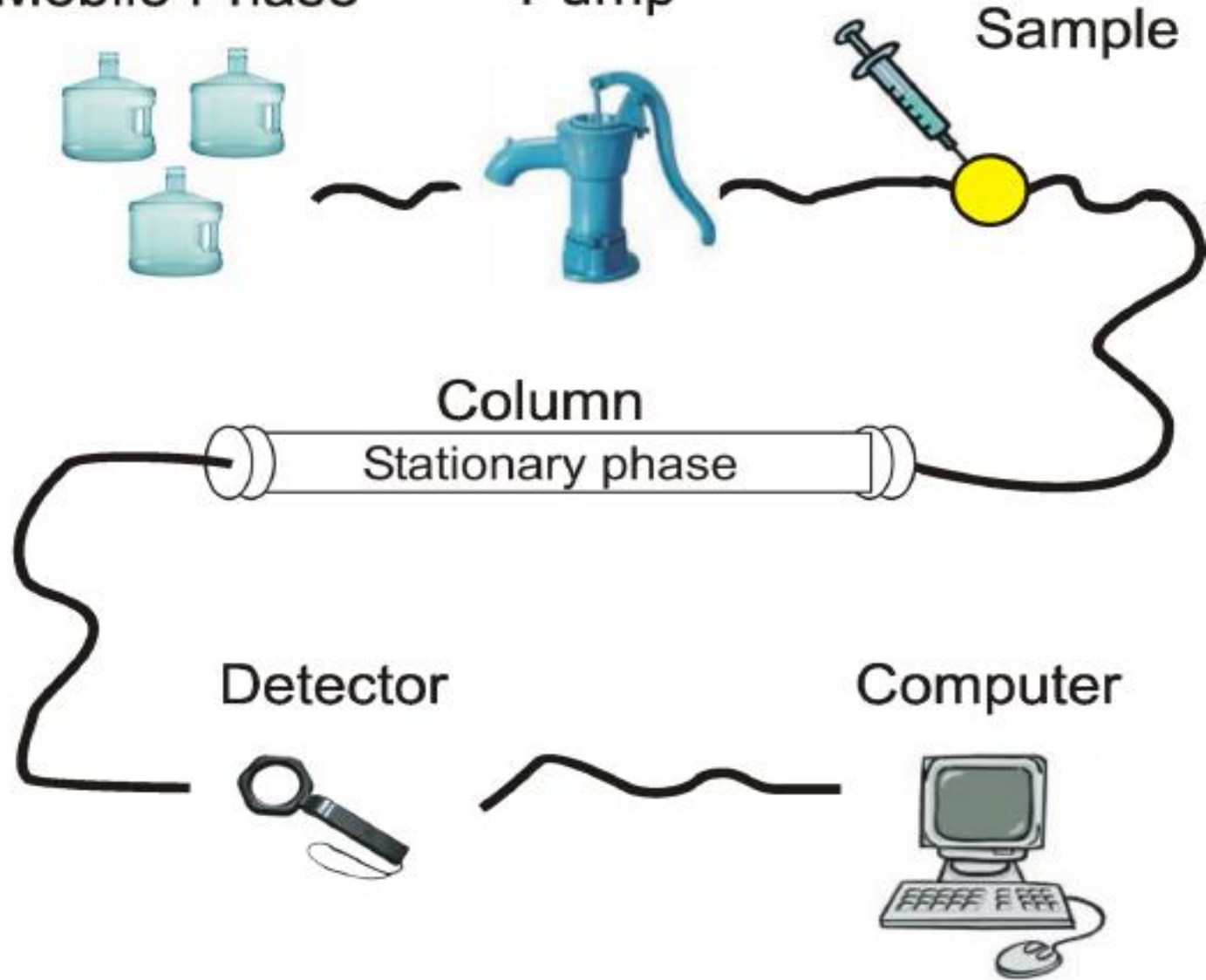

# Solvent reservoirs (eluent containers)

Storage of sufficient amount of **HPLC (grade) solvents** for continuous operation of the system. Could be equipped with an on-line degassing system and special filters to isolate the solvent from the influence of the environment.

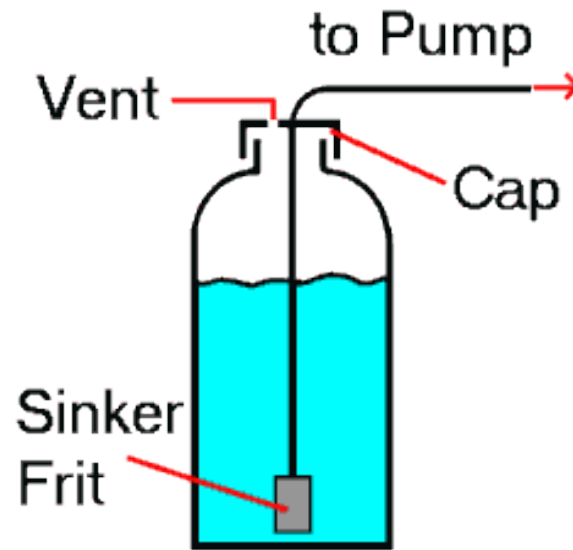
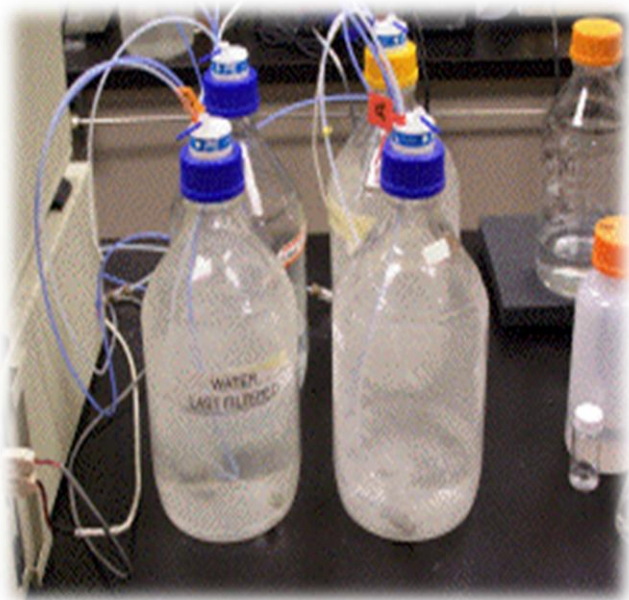



# Pump (solvent delivery system)

The function of the solvent delivery system is to deliver the mobile phase (eluent) through the system, accurately and reproducibly.

The solvent delivery system comprises the pump, check valves, flow controllers, pulse dampeners and pressure transducers. Delivery of the mobile phase must be pulse free to ensure minimal baseline noise from the pump.

The solvents should be highly pure (HPLC-grade)

Pumping systems are designed to deliver either a **single eluent** or **multiple** (binary, tertiary and even quaternary) eluents. These are known depending on application which significantly extends the capabilities of the technique.

- **isocratic** (constant mobile phase composition).
- **gradient** (variable composition with the analysis time).

# Isocratic vs. gradient elution ...

Similar to GC, solutes can be eluted from a column by using either a constant column conditions or gradient elution

**Isocratic elution**: use of a constant mobile phase composition to elute solutes simple (constant mobile phase composition).

- difficult to elute all solutes with good resolution in a reasonable
- amount of time → general elution problem

**Gradient elution**: changing the composition of the mobile phase with time → solvent programming (variable composition with the analysis time).

- going from a weak mobile phase to a strong one
- weak mobile phase → solvent A
- strong mobile phase → solvent B
- solvent change can be stepwise, linear or non-linear

1. Phosphoserine
2. Aspartic acid
3. Glutamic acid
4.  $\alpha$ -Amino adipic acid
5. Asparagine
6. Serine
7. Glutamine
8. Histidine
9. Glycine
10. Threonine
11. Citrulline
12. 1-Methylhistidine
13. 3-Methylhistidine
14. Arginine
15.  $\beta$ -Alanine
16. Alanine
17. Taurine
18. Anserine
19.  $\beta$ -Aminobutyric acid
20.  $\beta$ -Aminoisobutyric acid
21. Tyrosine
22.  $\alpha$ -Aminobutyric acid
23. Methionine
24. Valine
25. Tryptophan
26. Phenylalanine
27. Isoleucine
28. Leucine
29.  $\delta$ -Hydroxylysine
30. Lysine

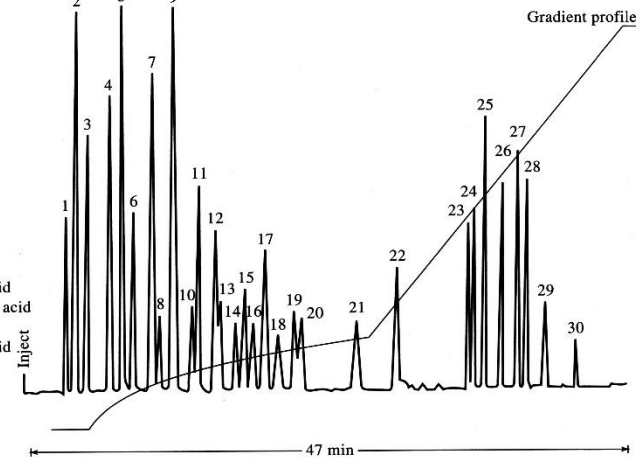

According to the eluent flow rate that the pump is capable of delivering, pumps may be defined as;

- microbore (1–250 $\mu$ L/min),
- standard bore (100 $\mu$ L/min to 10mL/min) or
- preparative (> 10mL/min).

Pumps may be constructed from metallic (steel or titanium) or nonmetallic (PEEK, teflon or ceramic), depending on the material used for the eluent flow path.

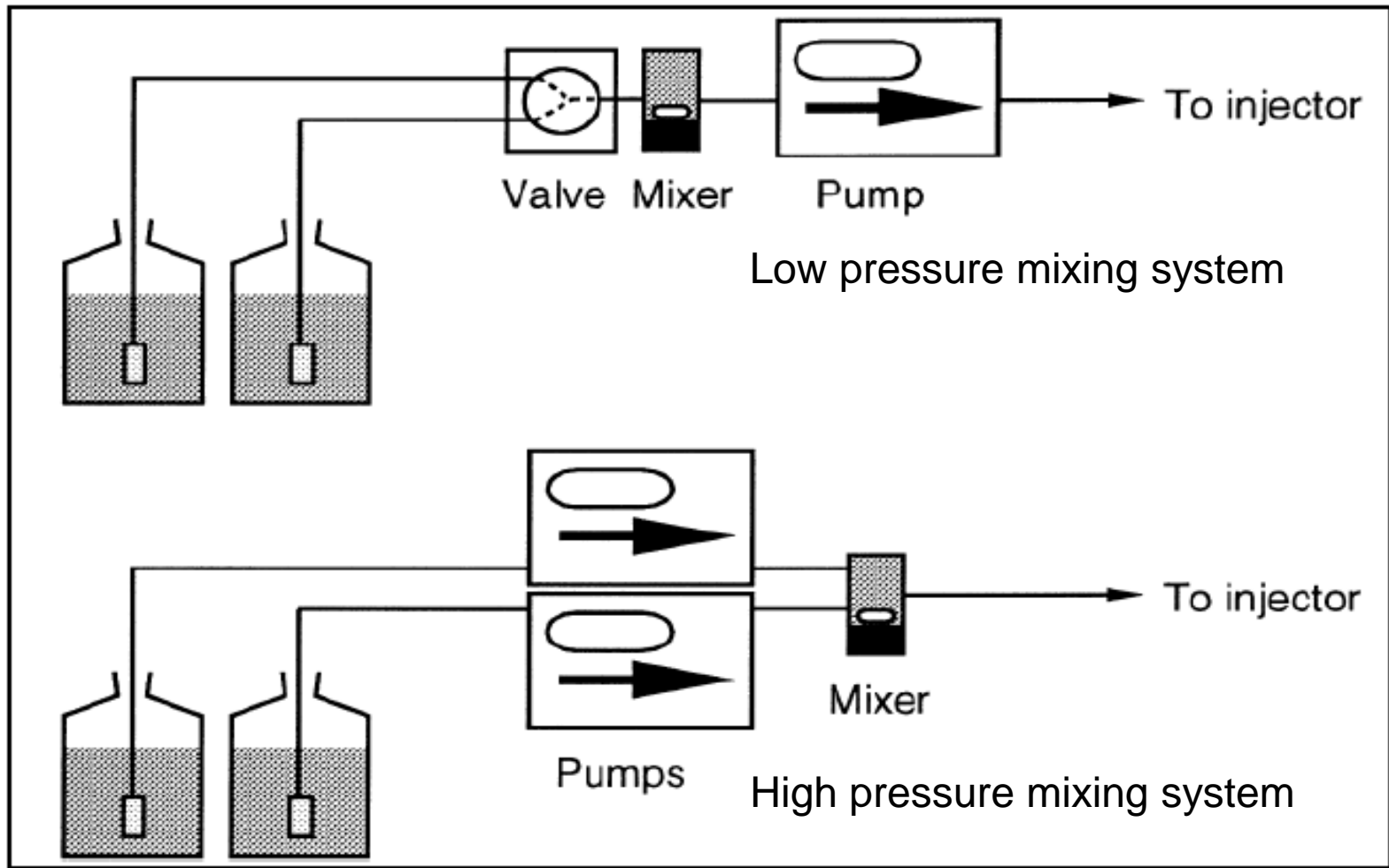

The blending of the solvents can occur in one of two basic ways. In the first, the solvent mixing occurs at high pressure and in the second the solvents are premixed at low pressure and then passed to the pump. The high pressure programmer is the simplest but most expensive as each solvent requires its own pump.

Nearly all LC pumps since the 1980's are based on one of two types according to the mechanism by which the liquid is forced through the chromatograph.

- **The reciprocating piston pump** is the most common design in modern HPLC, the pump head consists of two sets of moving parts: the check valves and seal piston assembly which may consist of both single or multi-head.
- **The syringe pump** remains popular for applications requiring pulseless solvent delivery, such as in microscale and capillary LC (where typical flow rates are less than  $100\mu\text{L}/\text{min}$ ) or in microbore HPLC connected to an interface to MS.

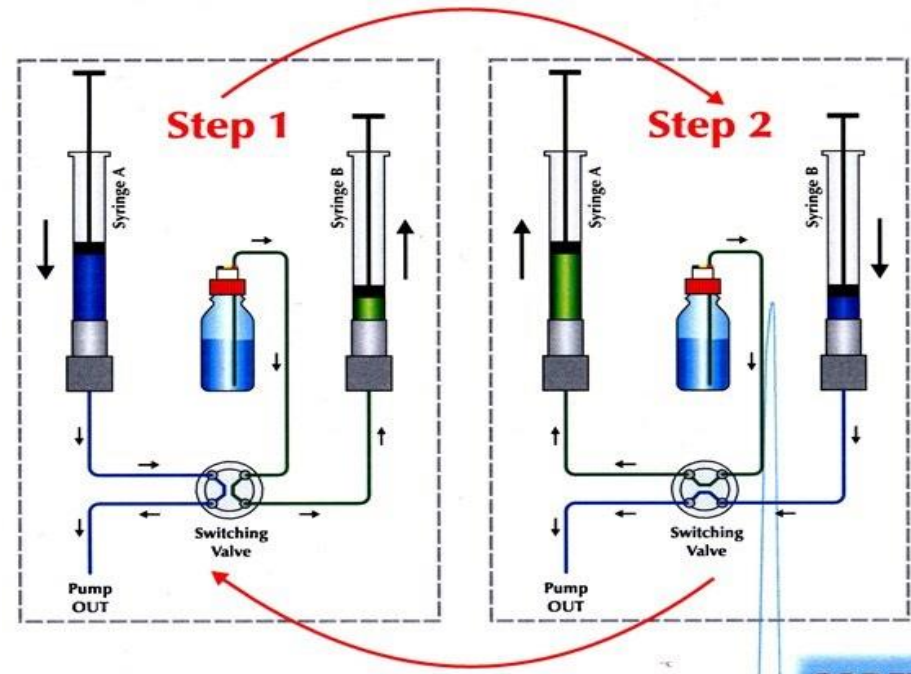
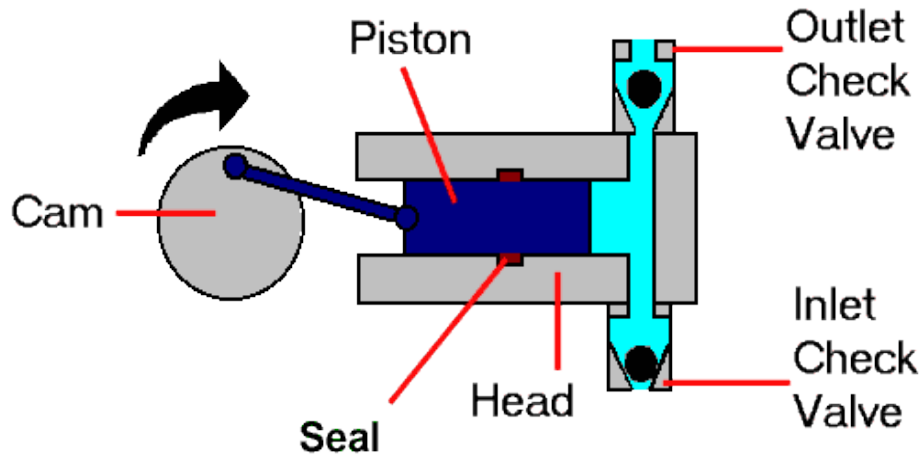

Modern HPLC systems have been improved to work at much higher pressures, and therefore be able to use much smaller particle sizes in the columns ( $< 2\mu\text{m}$ ). These are ultra performance liquid chromatography systems or **UPLC's**.

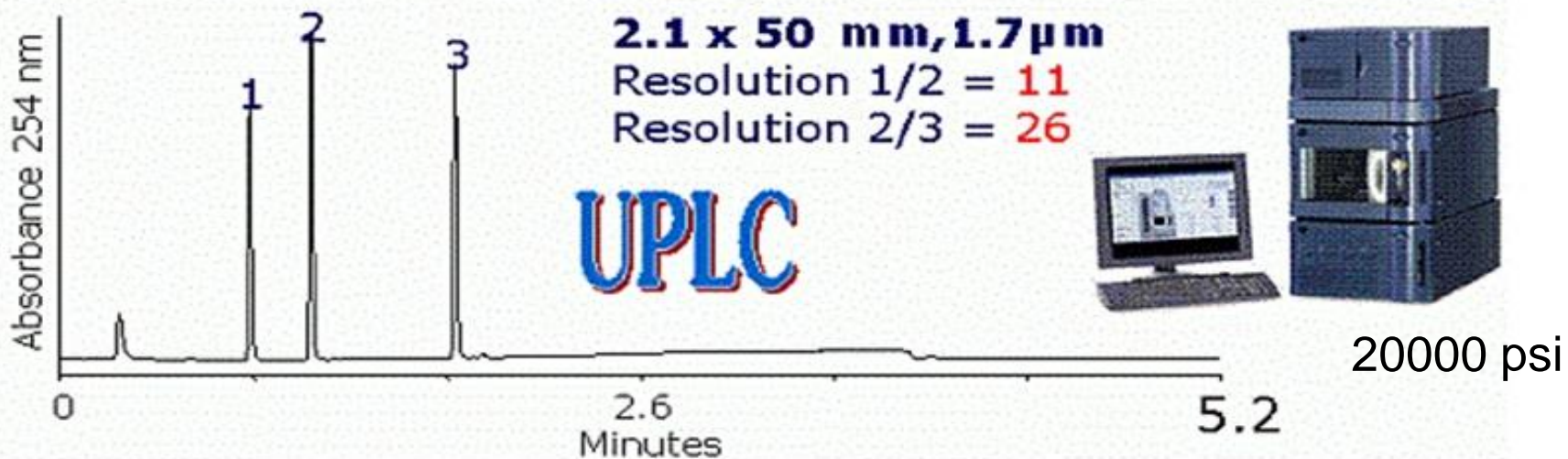
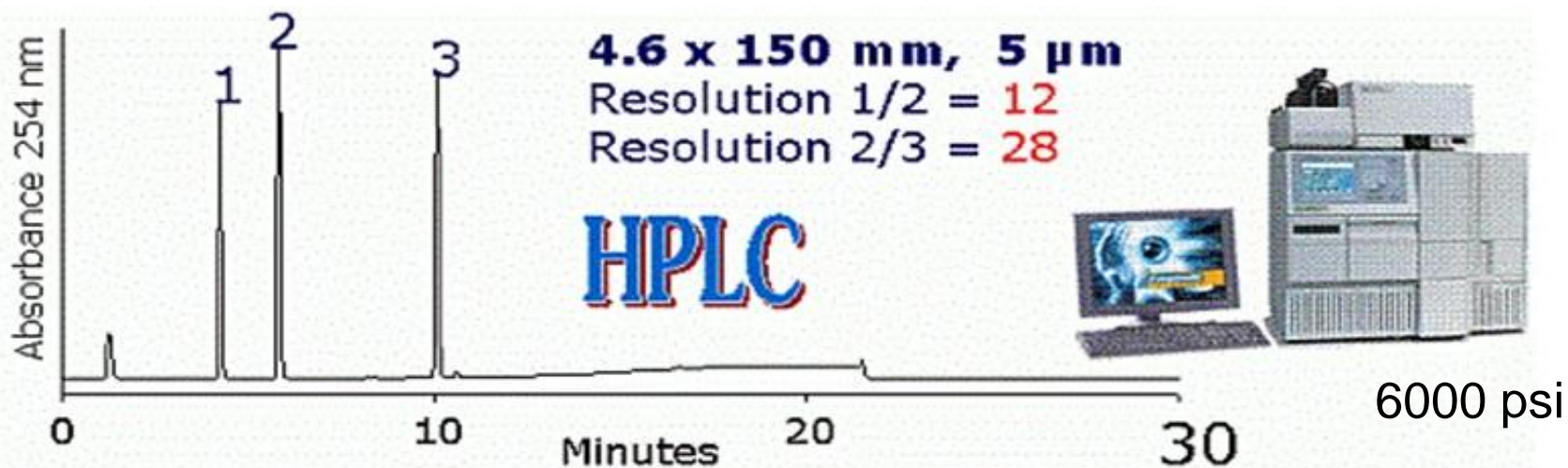

Solvent degassing is important to ensure that **air bubbles** do not outgas and interfere with accurate delivery of flow. Solvents can be degassed by:

- Ultrasonic degassing.
- External vacuum degassing.
- Bubbling helium gas into the eluent.
- On-line degassing methods.

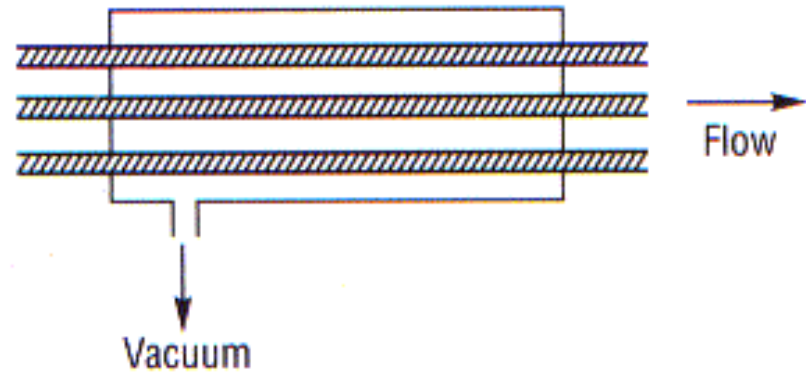
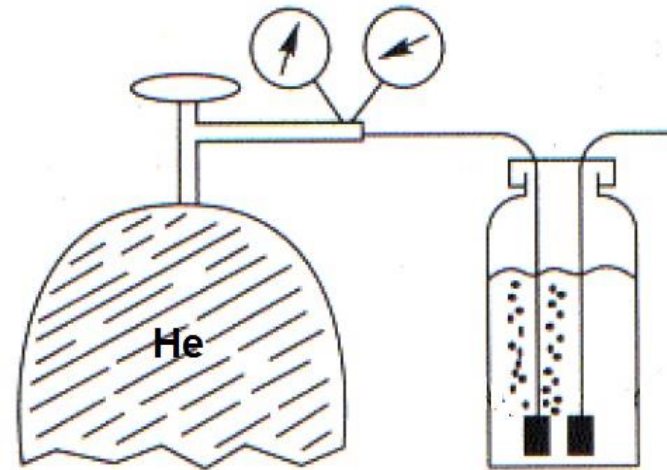
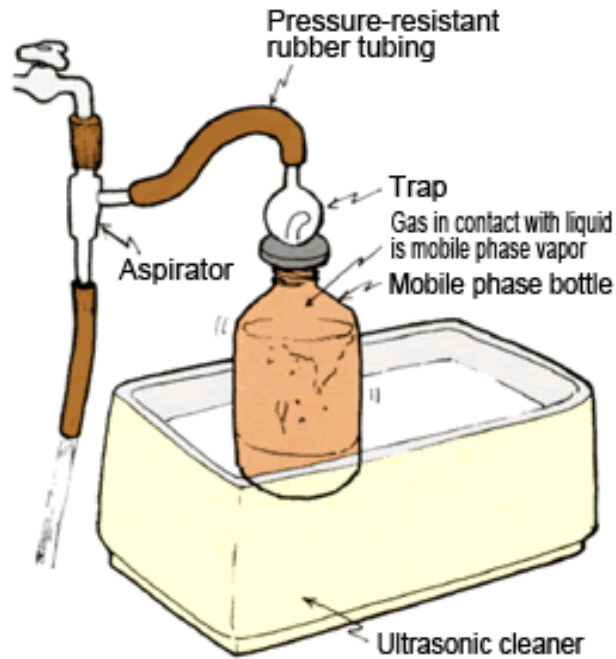

# Injector or a sample introduction system

Injection valves are connected between the pump and the column and as close to the top of the column as practically possible, this allows an introduction of the analytes mixture into the stream of the mobile phase before it enters the column.

An interchangeable sample loop of discreet volume is connected to the valve and isolated from the flow of mobile phase. The loop is filled with sample solution and the valve is then turned **manually** or **electronically** so that the loop is connected into the flowing mobile phase and the sample is thereby injected onto the column.

Most modern injectors are **autosamplers**, which allow programmed injections of different volumes of samples that are withdrawn from the vials in the autosampler tray.



# Syringe needle

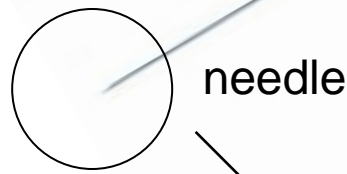
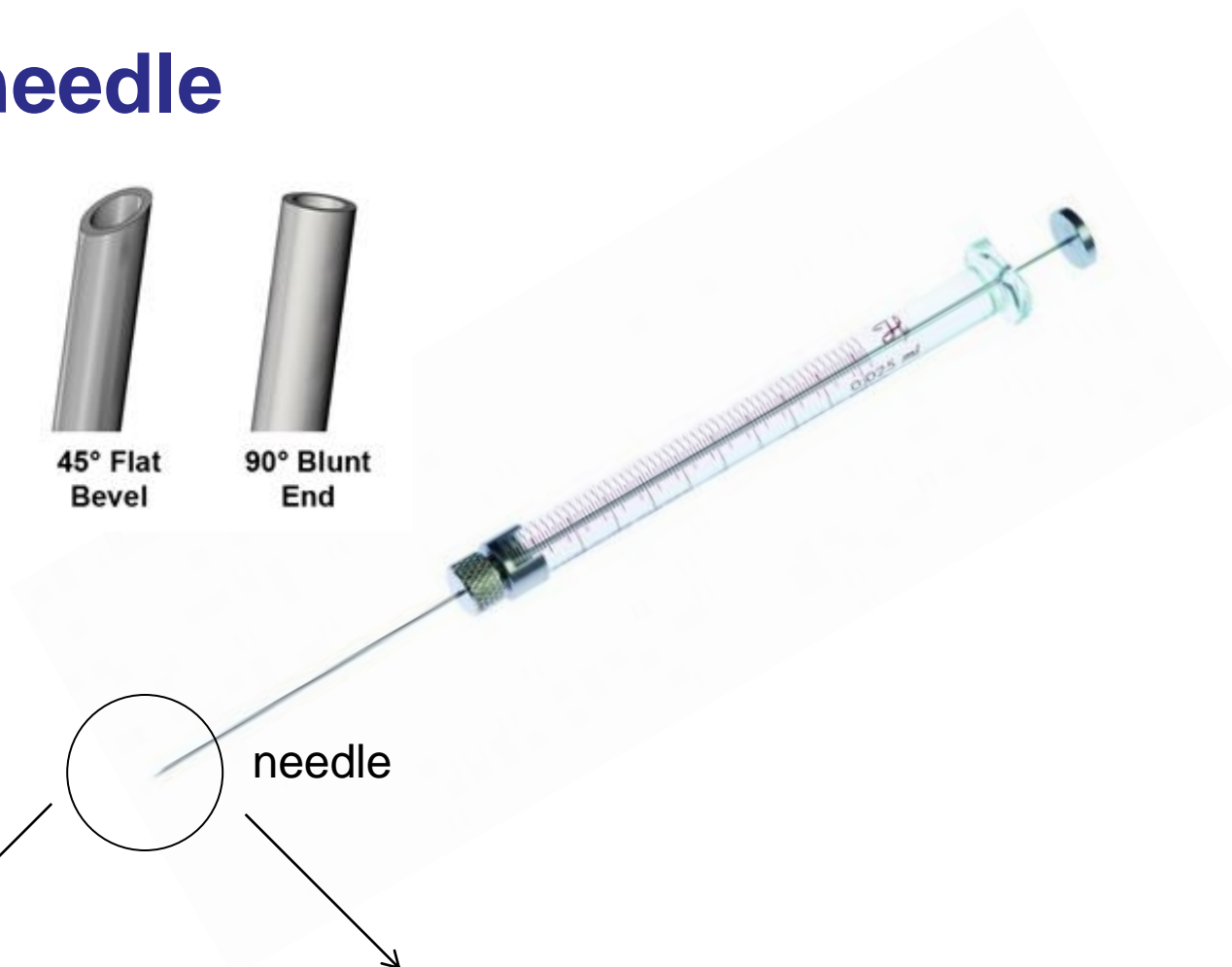
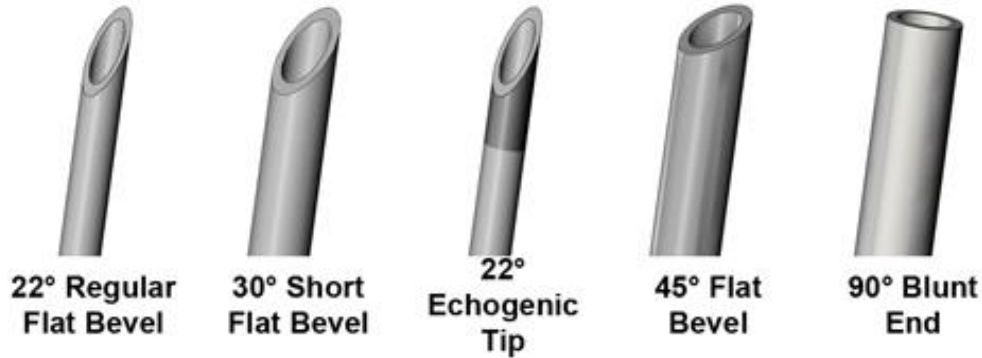

Bevel

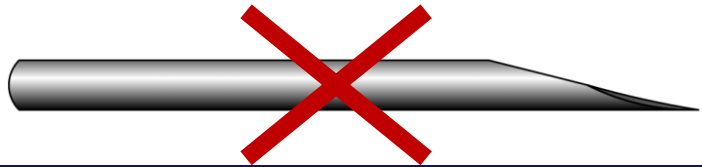

Blunt



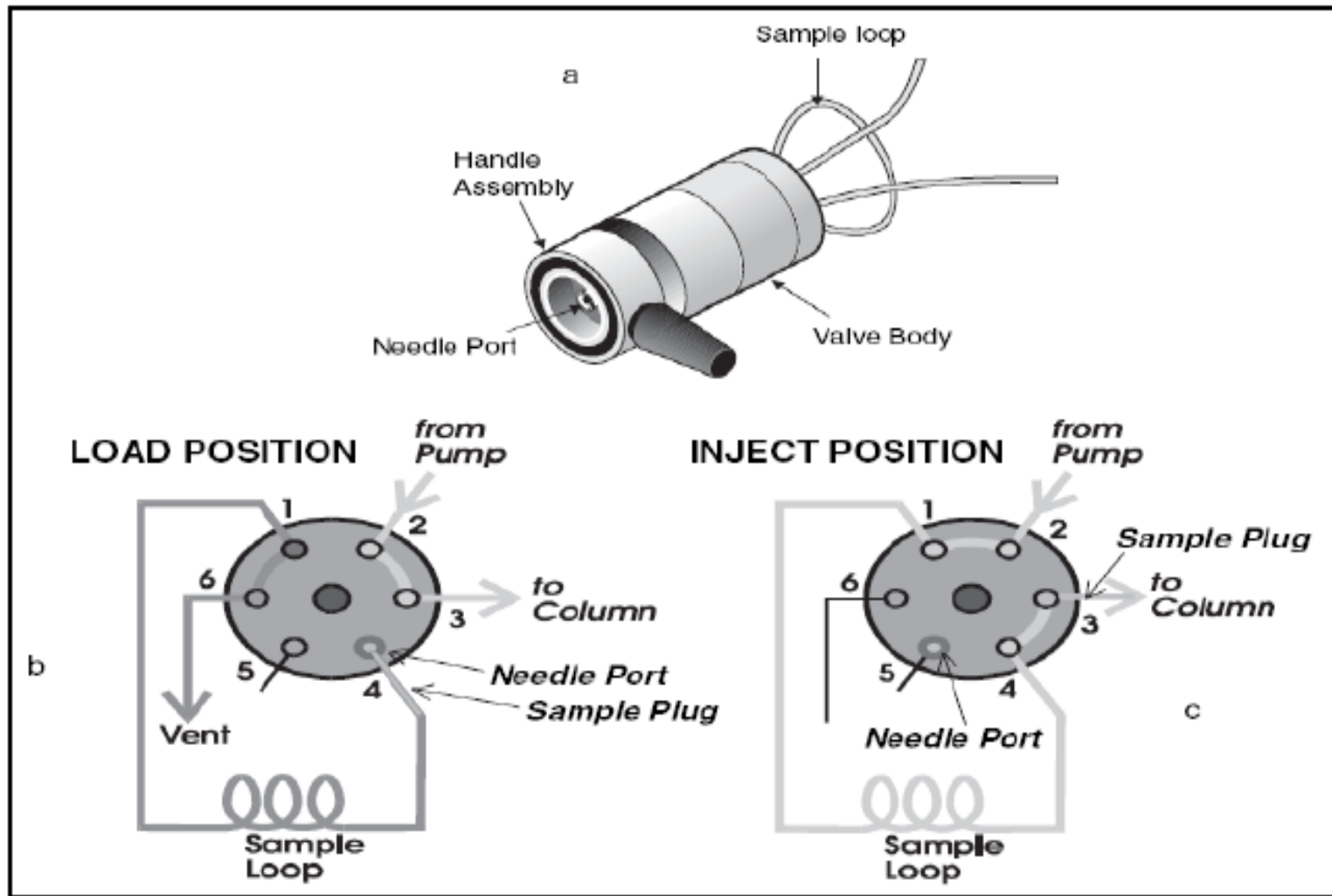

A common injector is the **Rheodyne** model, which consists of a six-port valve with a rotor, a sample loop and a needle port. A syringe with a **22-gauge (0.644 mm) blunt-tip needle** is used to introduce a precise sample aliquot into the sample loop.

# 6-port valve HPLC injector

« load » position

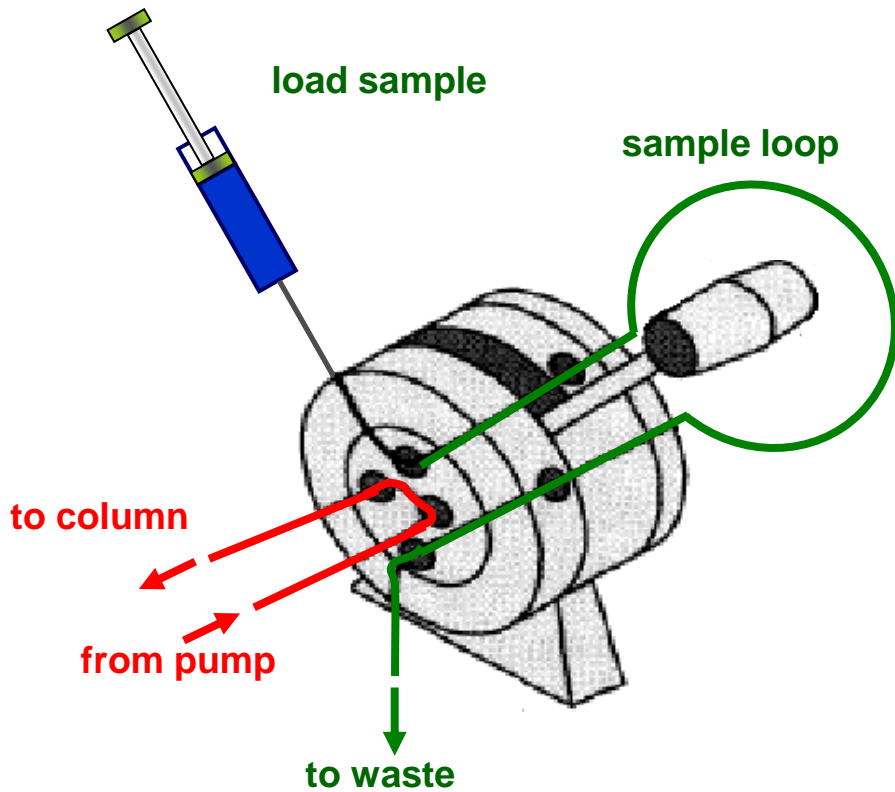

« inject » position

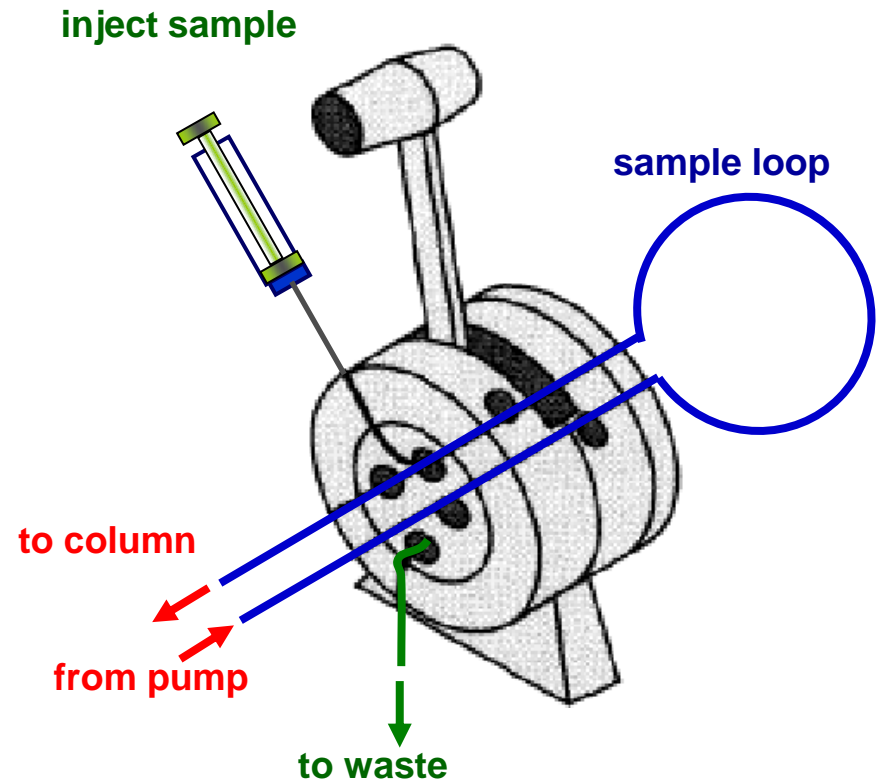

# Column

This is the **heart of HPLC system**; it actually produces a separation of the analytes in the mixture. Most of the chromatography development in recent years went toward the design of many different ways to enhance the columns properties and efficiencies.



# Detector

Although chromatography was discovered late in the 1890's, its development was almost negligible until the 1940's and this was largely due to the lack of an in-line sensitive detector.

The detector measures a **physical parameter** of the column effluent or of components in the column effluent and transform it to an **electrical signal**.

The detector must respond sufficiently fast to the changes in concentration or mass flow in the effluent, otherwise the peaks are distorted.

**Detectors can be classified into two types;**

- **Universal** (bulk property) detectors.

measures some bulk physical property of the **eluent** (such as dielectric constant or refractive index).

- **Selective** (solute property) detectors.

measures some physical or chemical property that is unique to the **solute** (such as heat of combustion or fluorescence).

Detectors may also be classified according to whether they are **destructive** or **nondestructive**. A nondestructive detector is one in which the sample is unaltered by the detection process. Nondestructive detectors are often used in series to obtain extra qualitative information.

Detector may be also be classified for solvent or solute property, and mass or concentration detection.

The choice of detector is often crucial to the success of a particular HPLC method.

The choice of detector is based on intrinsic **properties of the solute**.

Often more than one detector can be used to maximize sample information and confirm peak identities.

For example, an absorbance detector could be placed in series with a conductivity detector for the visualization of a charged, chromophoric solute.

# Spectroscopic Detection

## Ultraviolet (UV) Absorption

- An ultraviolet light beam is directed through a flow cell and a sensor measures the light passing through the cell.
- If a compound elutes from the column that absorbs this light energy, it will change the amount of light energy falling on the sensor.
- The resulting change in this electrical signal is amplified and directed to a recorder or data system.
- A UV spectrum is sometimes also obtained which may aid in the identification of a compound or series of compounds.

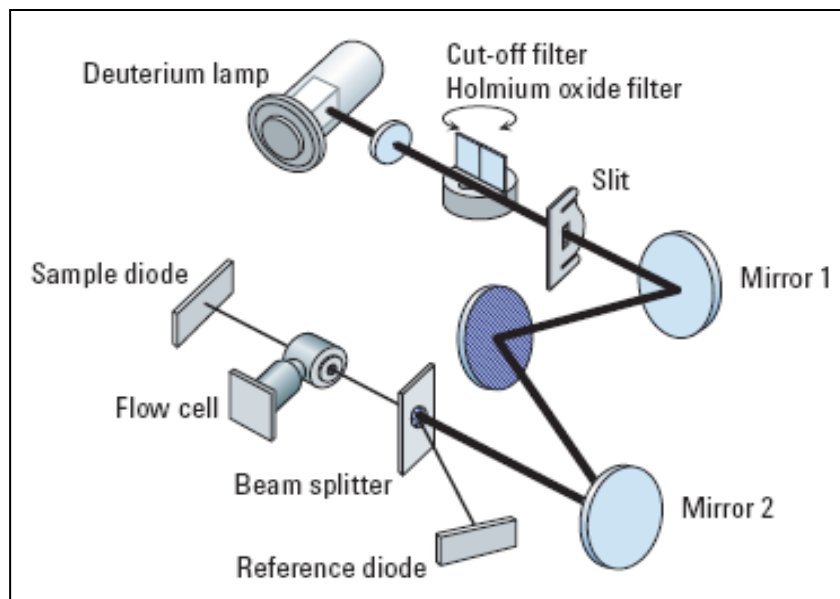

Variable wavelength detector

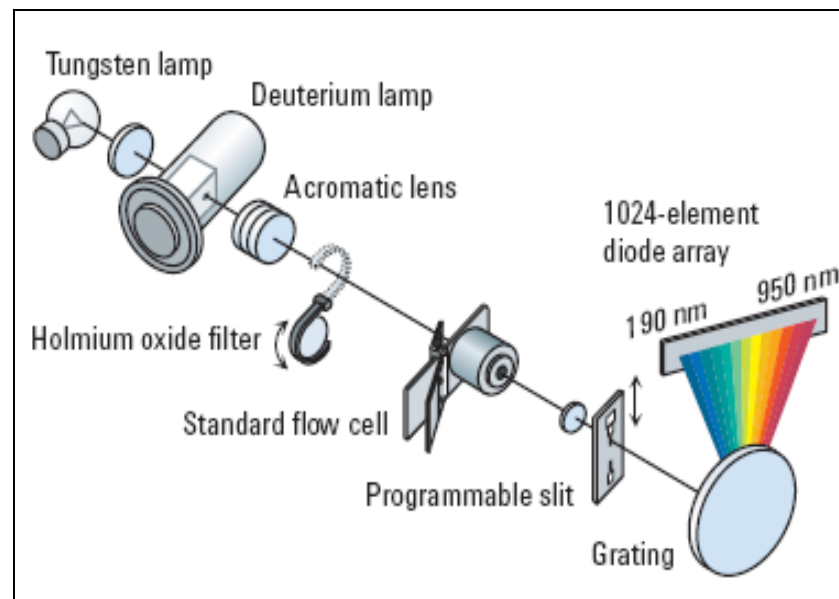

Diode array detector



# Spectroscopic Detection

## Mass Spectrometry (MS)

- An MS detector senses a compound eluting from the HPLC column first by ionizing it then by measuring its mass and/or fragmenting the molecule into smaller pieces that are unique to the compound.
- The MS detector can sometimes identify the compound directly since its mass spectrum is like a fingerprint and is quite unique to that compound.

Here is a mass spectrum of a simple chemical compound, **toluene**.

The pattern of lines is very unique to this compound. The largest peak in the spectrum occurs at a mass of 91, which is a fragment ion generated by loss of a hydrogen atom.

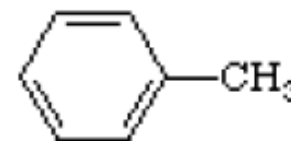
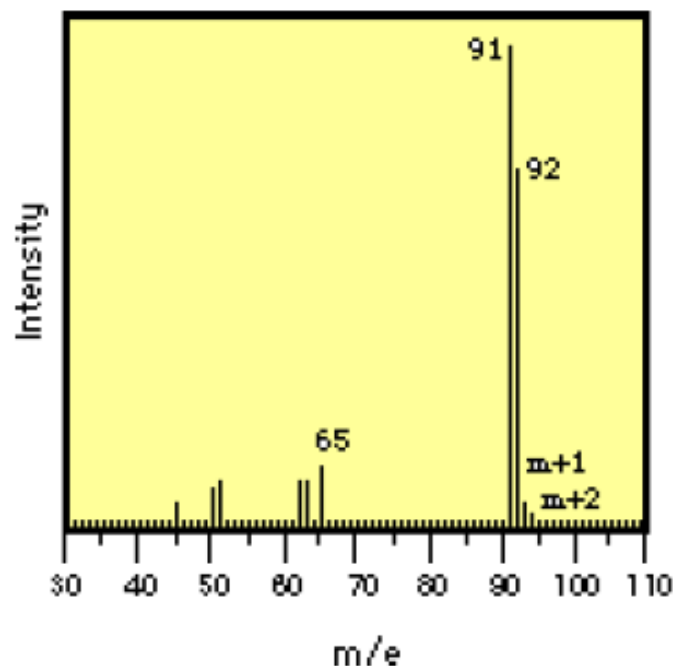

Toluene

# Reflective index (RI) detector

- The ability of a compound or solvent to deflect light provides a way to detect it.
- The RI is a measure of molecule's ability to deflect light in a flowing mobile phase in a flow cell relative to a static mobile phase contained in a reference flow cell.
- The amount of deflection is proportional to concentration.
- The RI detector is considered to be a universal detector but it is not very sensitive.

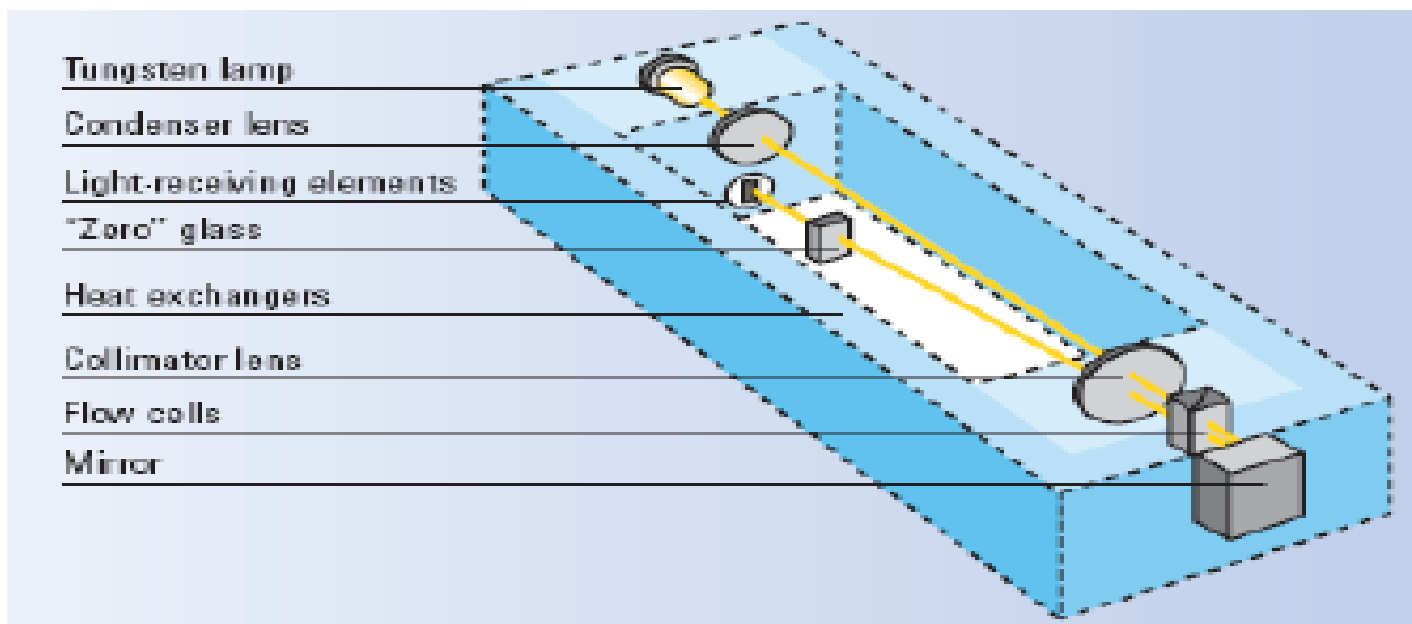

Schematic of a deflection type of RI detector

# Fluorescence detector

- Compared to UV-Vis detectors fluorescence detectors offer a higher sensitivity and selectivity that allows to quantify and identify compounds and impurities in complex matrices at extremely low concentration levels (trace level analysis).
- Fluorescence detectors sense only those substances that fluoresce.

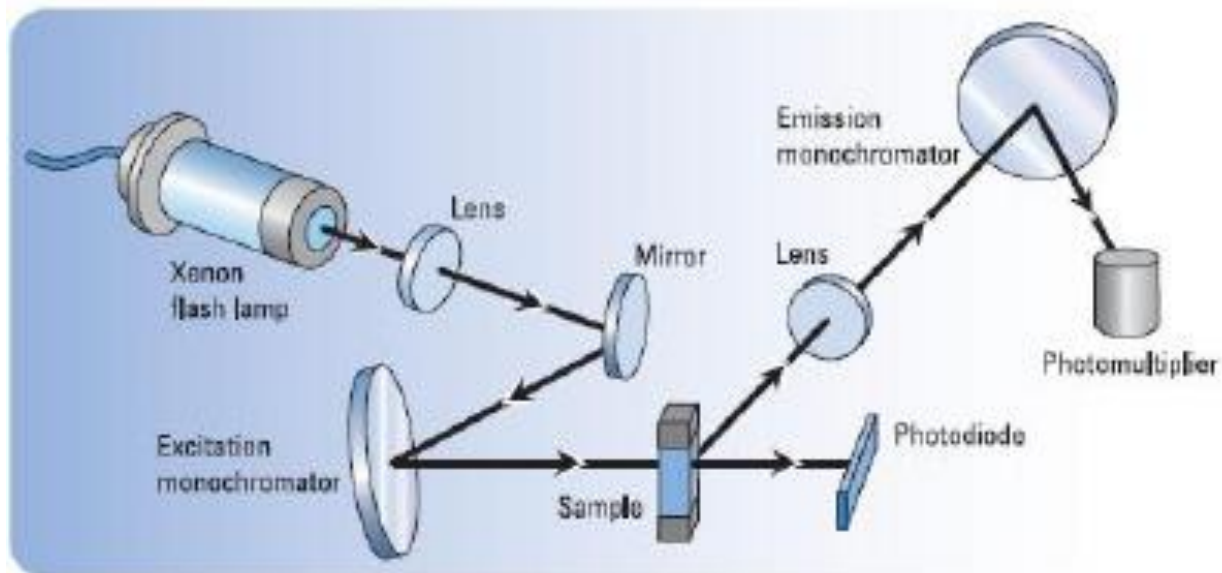

Schematic of a fluorescence detector

# Electrochemical detector

- Respond to those substances that are oxidizable or reducible.
- A reaction takes place at the surface of electrode, due to which generation of electron leads to production of electrical signals.

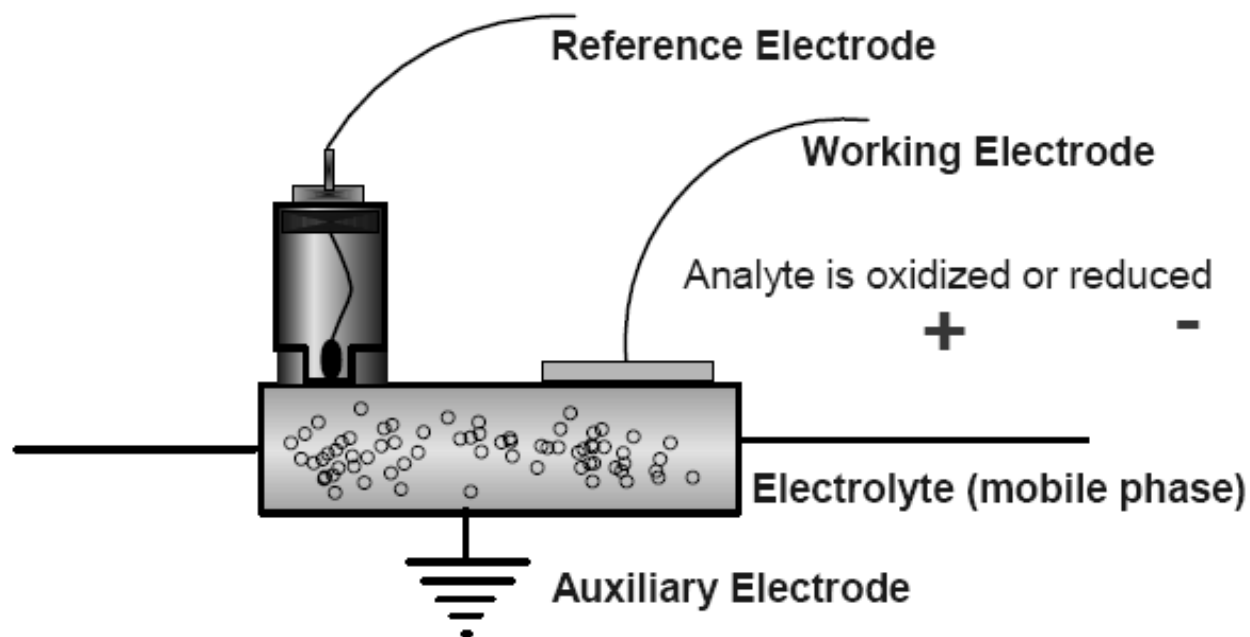

As compounds are oxidized or reduced, a current proportional to concentration is produced.

# Electrical conductivity detector

- Provides universal reproducible and high sensitivity detection of all charged species such as anions, cations, metals, organic acids and surfactants.
- These detectors measure conductivity of the total mobile phase hence categorized in bulk density detectors.
- Consist of a flow through cell which has a few  $\mu\text{L}$  of volume containing two electrodes. Electrodes are usually made up of platinum, stainless steel or some other noble metal.
- The mobile phase must be made electrically conductive, usually by the addition of a suitable salt.

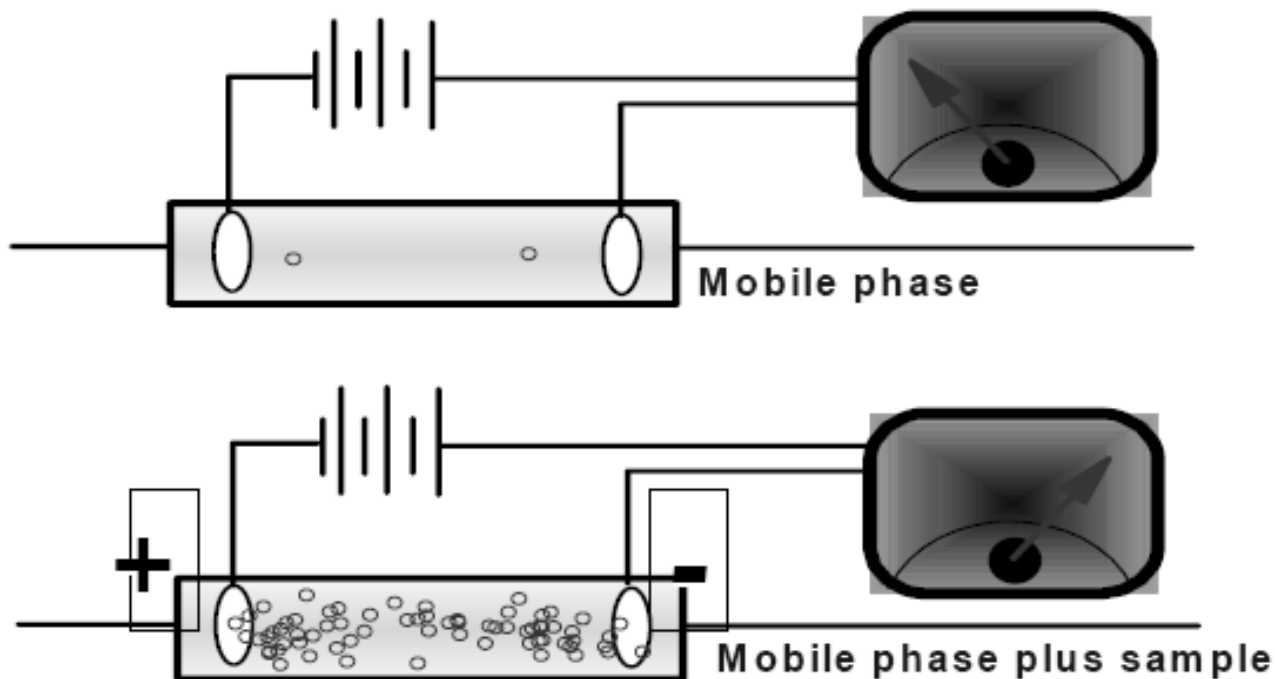

# Light scattering detector

- These detectors are based on measurement of scattered light.
- When light is scattered by a polymer or large molecular weight substance present in the column eluent, it is examined by passing through an appropriate sensor cell.
- Scattering is dependent on particle size.
- High intensity beam of light is used for illuminating the scattered light which is achieved by the use of a laser.

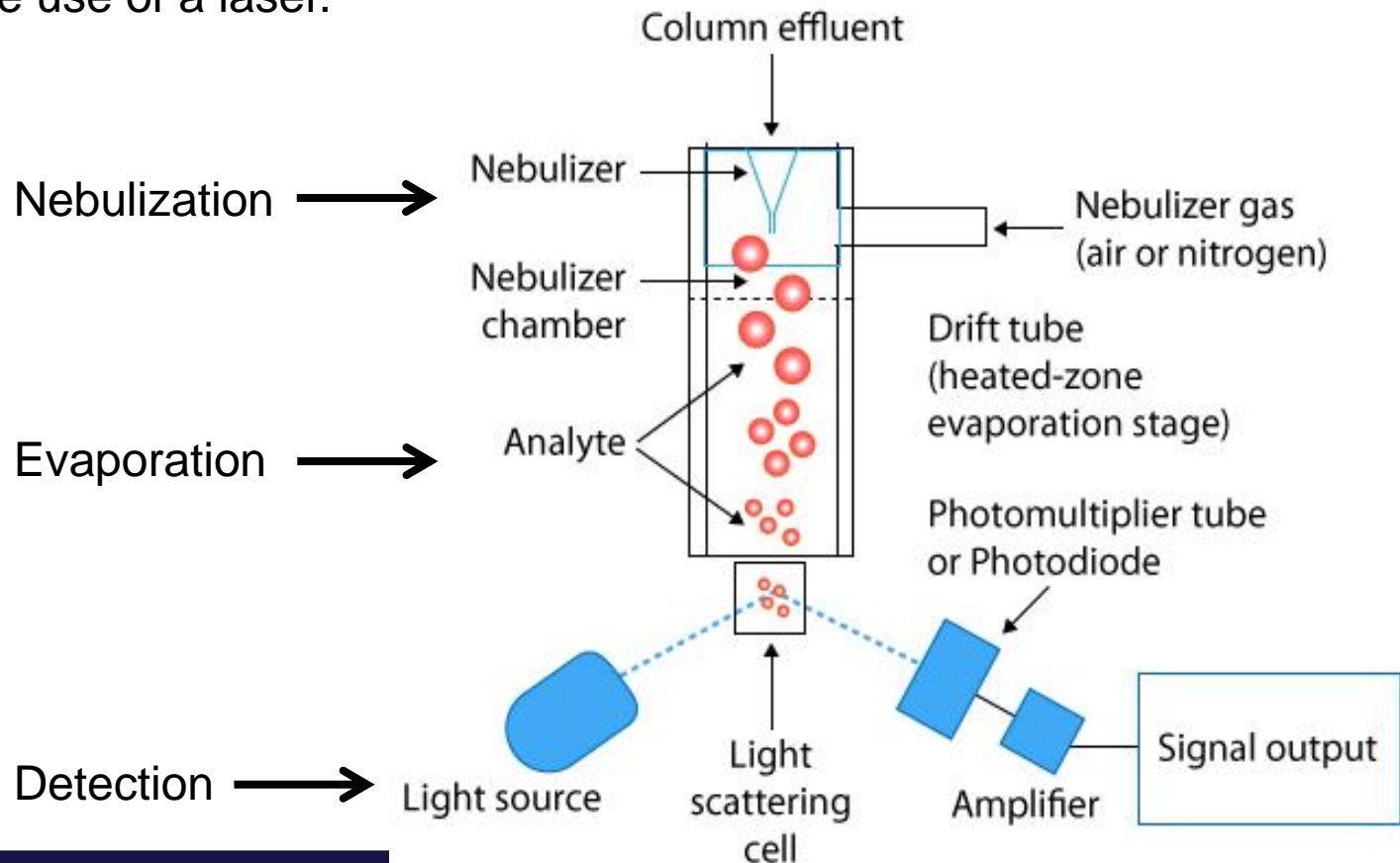

# Properties of HPLC detectors

HPLC Detector	Commercially Available	Mass LOD* (typical)	Linear Range† (decades)
Absorbance	Yes	10 pg	3–4
Fluorescence	Yes	10 fg	5
Electrochemical	Yes	100 pg	4–5
Refractive index	Yes	1 ng	3
Conductivity	Yes	100 pg–1 ng	5
Mass spectrometry	Yes	<1 pg	5
FTIR	Yes	1 µg	3
Light scattering	Yes	1 µg	5
Optical activity	No	1 ng	4
Element selective	No	1 ng	4–5
Photoionization	No	<1 pg	4

# Data acquisition and control system

Computer based systems are used in every instrumental module and at every stage of analysis. Computers control the flow rate, eluent composition, temperature, injection volume and injection process. Detector output signal is converted from analog form into the digital representation to recognize the presence of peaks, and then at a higher level of computer analysis a chromatogram is obtained.

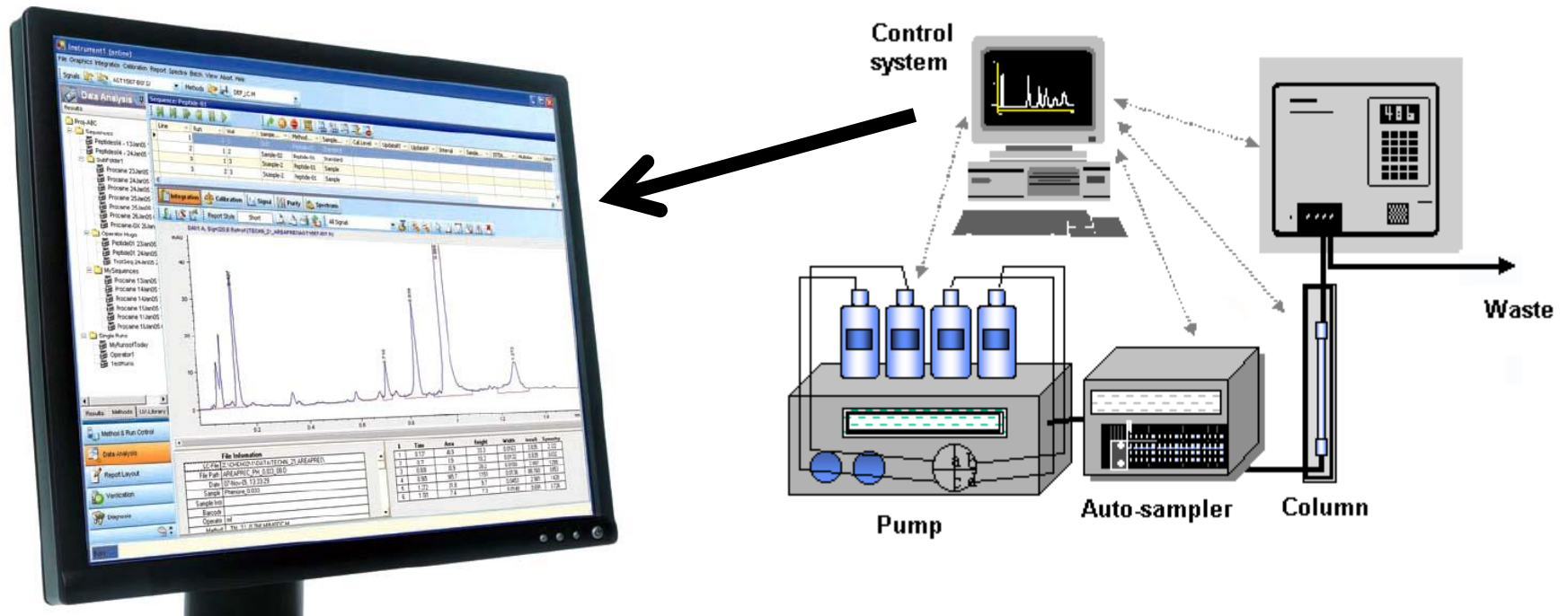



# Columns and stationary phases

Although it is usually the smallest one, the column is the most important part in any HPLC system. The column is the only device in the HPLC system which actually separates an injected mixture. Column packing materials are the media producing the separation, and properties of this media are of primary importance for successful separations. The selectivity, capacity and efficiency of the column are all affected by the nature of the packing material or the materials of construction.

Great varieties of different columns are currently available on the market. Four distinct characteristics could be used for column classification:

- (1)** Type (porous; nonporous and monolithic).
- (2)** Geometry (surface area; pore volume; pore diameter; particle size; shape; etc.).
- (3)** Surface chemistry (type of bonded ligands; bonding density; etc.).
- (4)** Type of base material (silica; polymeric; alumina; zirconia; etc).

# Irregularly shaped silica

## First generation (~ 1970)

- Synthesis via *SIL-GEL* condensation ; grinded and sieved.
- Irregular material contaminated with metal ions ( $\text{Fe}^{2+/3+}$ ,  $\text{Na}^+$ ,  $\text{Ca}^{2+}$ ,  $\text{Al}^{3+}$ , approx. 25-75 ppm)
- In use for preparative LC (FLASH, large scale).

**POLYGOSIL®**

**Particle size: 7  $\mu\text{m}$**

**SEM micrograph**

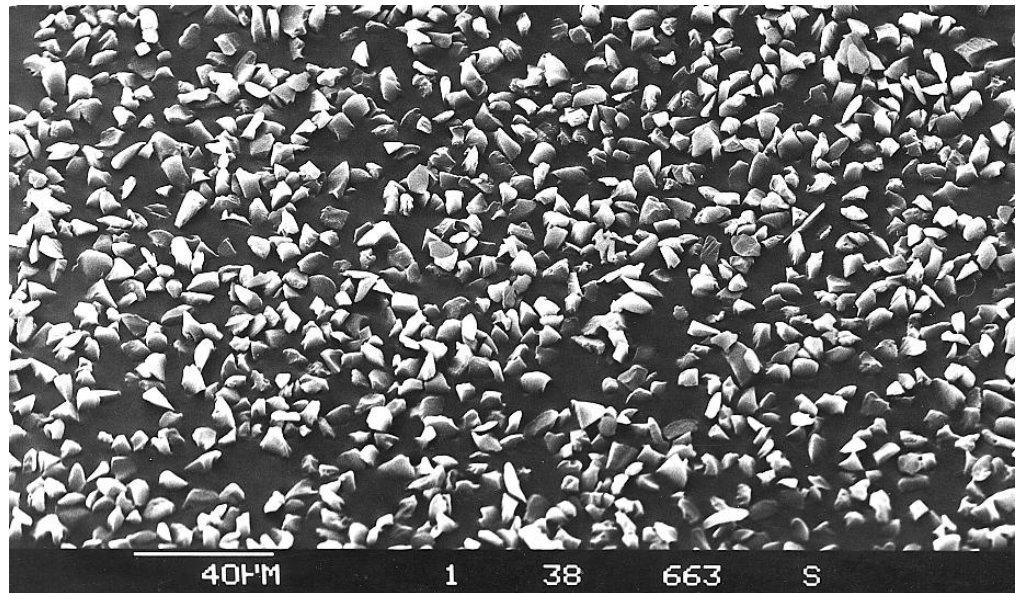

# Spherical silica

## 2nd generation (since ~ 1975)

- Synthesis via *SIL-GEL* condensation.
- Spherical material contaminated with metal ions ( $\text{Fe}^{2+/3+}$ ,  $\text{Na}^+$ ,  $\text{Ca}^{2+}$ ,  $\text{Al}^{3+}$ , approx. 25-75 ppm).
- Higher efficiency than irregular silicas in packed HPLC columns.

e.g. colloidal silica solution is sprayed into fine droplets and subsequently dried in a hot air stream.

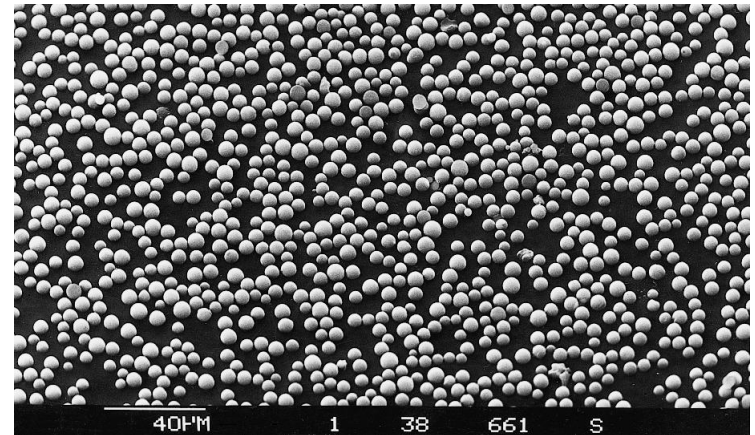

NUCLEOSIL® particle size: 7 μm

# Spherical silica

## 3rd generation (since ~ 1985)

- Synthesis via *Sol-Gel* condensation of alkoxy silanes.
- Spherical material, very homogeneous surface, high mechanical stability.
- Very low concentration of metal ions (< 10 ppm) [*ultra-pure*].

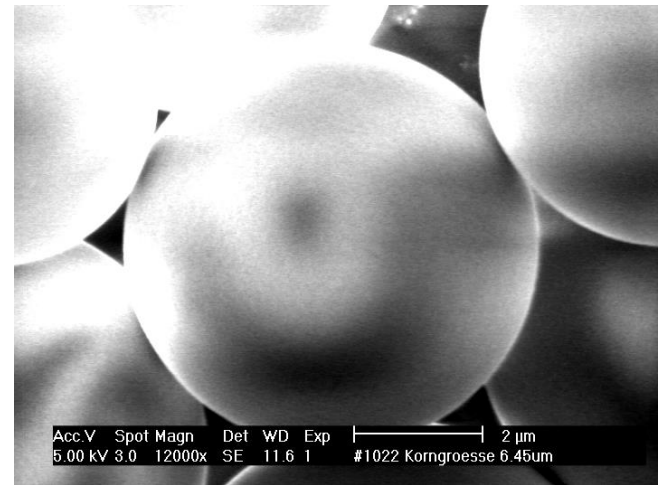
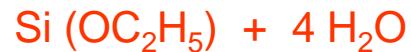

NUCLEODUR® (particle size: 5 μm), SEM]

# Monolith material

4th generation (since ~ 1996)

Monoliths are a single block piece of continuous materials made of highly porous rods with two types of bimodal pore structure distribution (macropores and mesopores).

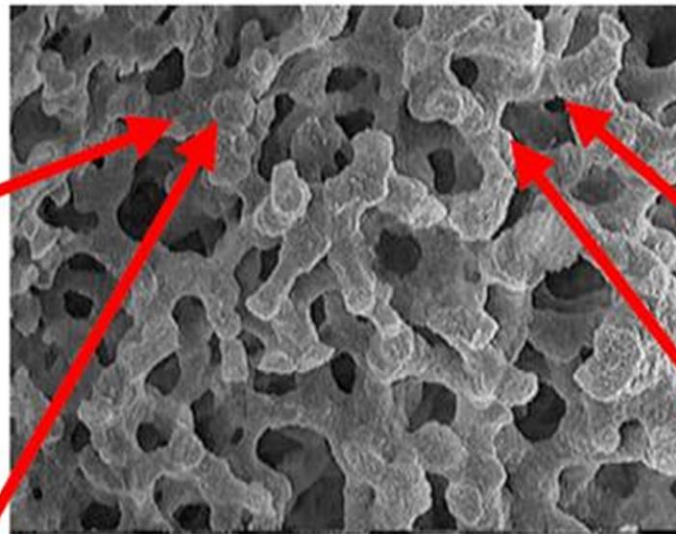

SEM of a cross section of a silica monolith

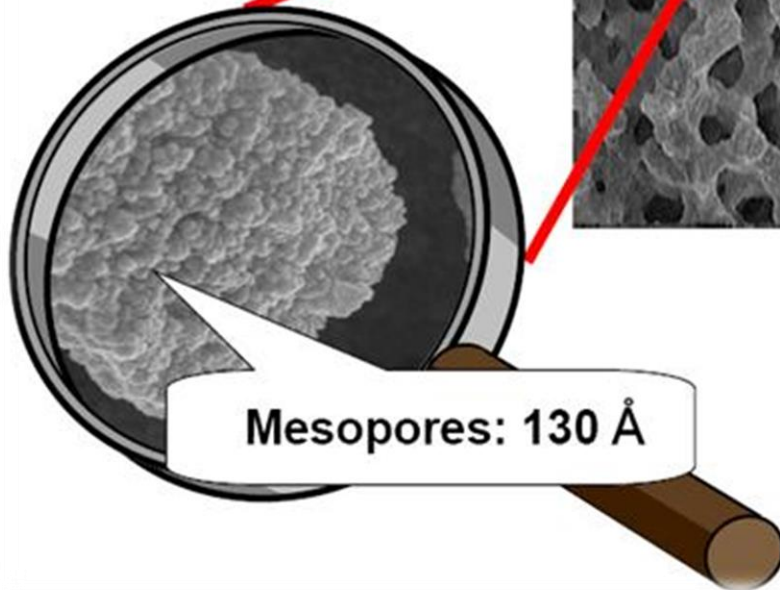

Mesopores: 130 Å

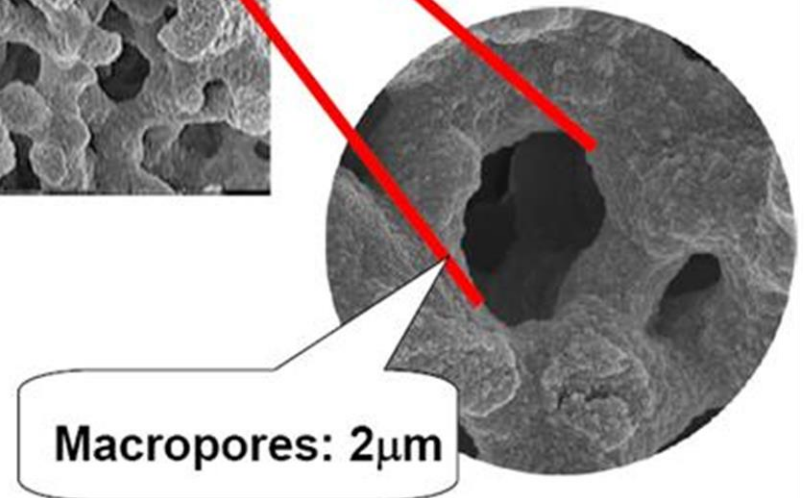





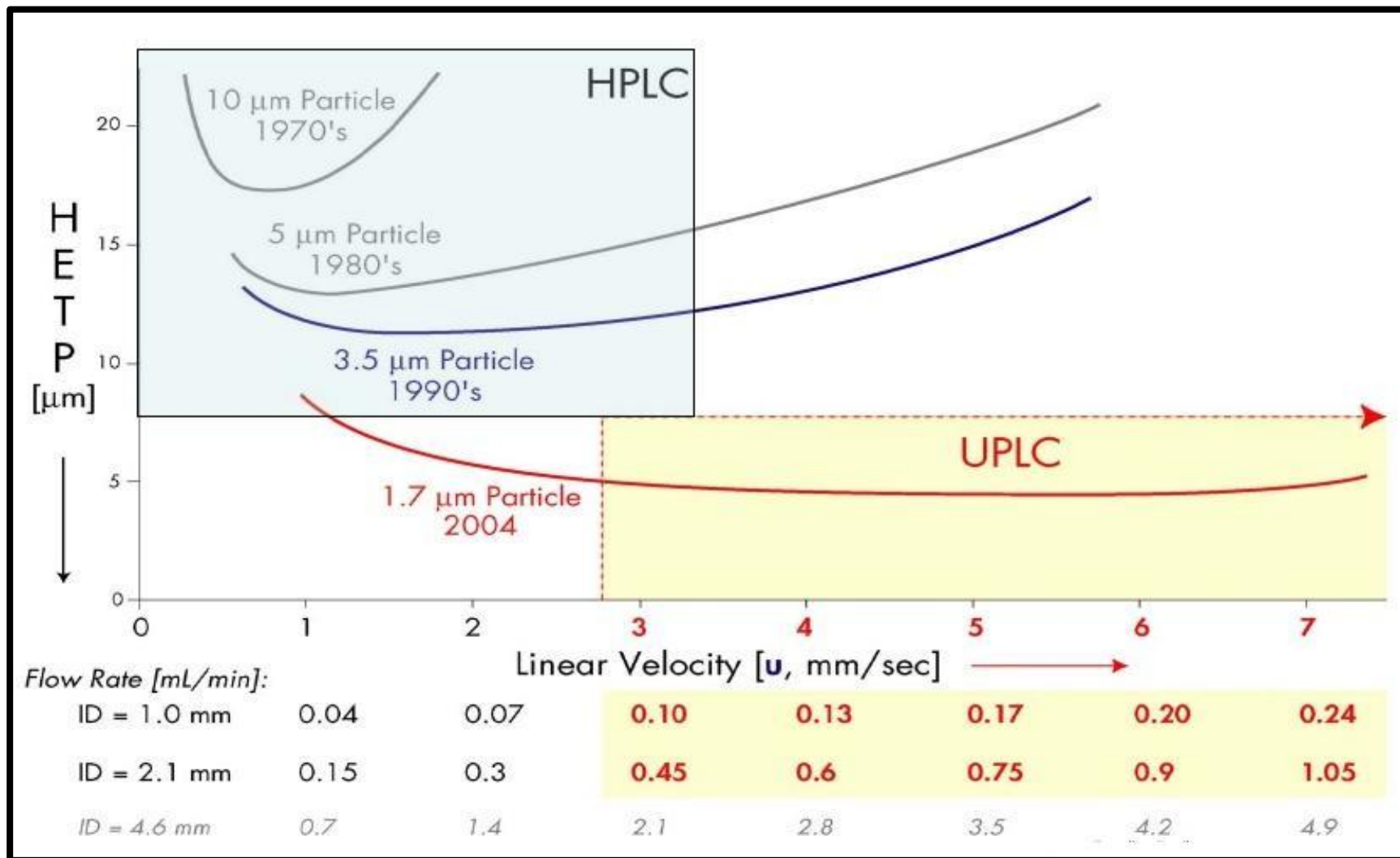

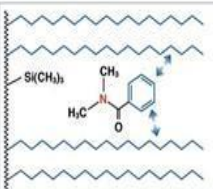

Macropores: 2µm

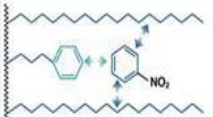
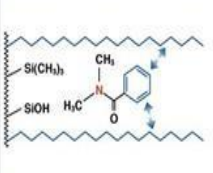
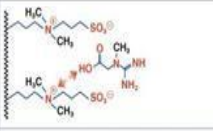
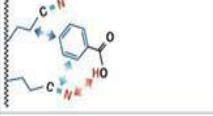
# Particle diameter

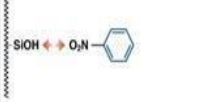

van Deemter plot, illustrating the evolution of particle sizes.

Phase	Specification	Characteristics*	Stability	Structure	Application	Similar phases**	Separation principle · Retention mechanism	
C <sub>18</sub> / C <sub>8</sub> Gravity	octadecyl phase, high density coating multi-endcapping C <sub>18</sub> Gravity: 18% C · USP L1 C <sub>8</sub> Gravity: 11% C · USP L7	A	pH stability 1 – 11, suitable for LC/MS	NUCLEODUR® (Si-O <sub>2</sub> ) <sub>n</sub>	in general compounds with ionizable functional groups such as basic pharmaceuticals and pesticides  for C8 Gravity generally shorter retention times for nonpolar compounds	NUCLEOSIL® C <sub>18</sub> HD Waters Xterra® RP <sub>18</sub> / MS C <sub>18</sub> ; Phenomenex Luna C18 (2), Synergi™ and Max RP; Zorbax Extend C18; Inertsil ODS III; Purospher RP-18; Star RP-18  NUCLEOSIL® C <sub>8</sub> HD; Waters Xterra® RP <sub>8</sub> / MS C <sub>8</sub> ; Phenomenex Luna C8; Zorbax Eclipse; XDB-C8	only hydrophobic interactions (van der Waals interactions)	
		B						
		C						
C <sub>18</sub> Isis	octadecyl phase with specially crosslinked surface modification endcapping 20% C · USP L1	A	pH stability 1 – 10, suitable for LC/MS	NUCLEODUR® (Si-O <sub>2</sub> ) <sub>n</sub>	high steric selectivity, thus suited for separation of positional and structural isomers, planar/nonplanar molecules	NUCLEOSIL® C <sub>18</sub> AB Inertsil ODS-P; YMC Pro C18RS	steric interactions and hydrophobic interactions	
		B						
		C						
C <sub>18</sub> Pyramid	C <sub>18</sub> modification with polar endcapping 14% C · USP L1	A	stable against 100% aqueous eluents, pH stability 1 – 9, suitable for LC/MS	NUCLEODUR® (Si-O <sub>2</sub> ) <sub>n</sub>	basic pharmaceutical ingredients, very polar compounds, organic acids	Phenomenex Aqua; YMC AQ; Waters Atlantis® dC18	hydrophobic interactions and polar interactions (H bonds)	
		B						
		C						
Sphinx RP	bifunctional RP phase, propylphenyl and C <sub>18</sub> ligands; endcapping 15% C; USP L1 and L11	A	pH stability 1 – 10, suitable for LC/MS	NUCLEODUR® (Si-O <sub>2</sub> ) <sub>n</sub>	compounds with aromatic and multiple bond systems	no similar phases	π-π interactions and hydrophobic interactions	
		B						
		C						
C <sub>18</sub> ec C <sub>8</sub> ec	octadecyl / octyl phase, medium density coating endcapping C <sub>18</sub> ec: 17.5% C · USP L1 C <sub>8</sub> ec: 10.5% C · USP L7	A	pH stability 1 – 9	NUCLEODUR® (Si-O <sub>2</sub> ) <sub>n</sub>	robust C18 / C8 phase for routine analyses	NUCLEOSIL® C <sub>18</sub> Spherisorb® ODS II; Hypersil ODS; Waters Symmetry® C18; Inertsil ODS II; Kromasil C18; LiChrospher RP 18  NUCLEOSIL® C <sub>8</sub> ec / C <sub>8</sub> Spherisorb® C8; Hypersil MOS; Waters Symmetry® C8; Kromasil C8; LiChrospher RP 8	only hydrophobic interactions (van der Waals interactions)  some residual silanol interactions	
		B						
		C						
HILIC	zwitterionic ammonium sulfonic acid modification 7% C	A	pH stability 2 – 8.5, suitable for LC/MS	NUCLEODUR® (Si-O <sub>2</sub> ) <sub>n</sub>	hydrophilic compounds such as organic polar acids and bases, polar natural compounds	Merck Sequant ZIC®-HILIC; Sielc Obelisc™	ionic / hydrophilic interactions, electrostatic interactions	
		B						
		C						
CN / CN-RP	cyano (nitrile) phase for NP and RP separations 7% C · USP L10	A	pH stability 1 – 8, stable towards highly aqueous mobile phases	NUCLEODUR® (Si-O <sub>2</sub> ) <sub>n</sub>	polar organic compounds (basic drugs), molecules containing π electron systems	NUCLEOSIL® CN / CN-RP	π-π interactions, polar interactions (H bonds), hydrophobic interactions	
		B						
		C						
NH <sub>2</sub> / NH <sub>2</sub> -RP	amino phase for NP and RP separations 2.5% C · USP L8	A	pH stability 1 – 8, stable towards highly aqueous mobile phases	NUCLEODUR® (Si-O <sub>2</sub> ) <sub>n</sub>	sugars, sugar alcohols and other hydroxy compounds, DNA bases, polar compounds in general	NUCLEOSIL® NH <sub>2</sub> / NH <sub>2</sub> -RP	polar / ionic interactions, hydrophobic interactions	
		B						
		C						
SiOH	unmodified high purity silica USP L3	A	pH stability 2 – 8	NUCLEODUR® (Si-O <sub>2</sub> ) <sub>n</sub>	polar compounds in general	unmodified NUCLEOSIL®	polar / ionic interactions	
		B						
		C						

\* A =  hydrophobic selectivity, B =  polar/ionic selectivity, C =  steric selectivity

\*\* phases which provide a similar selectivity based on chemical and physical properties

## Common packings in partition chromatography

Main applications	
<b>normal phase</b>	
amino: $-\text{NH}_2$	sugar analysis and aromatic compounds
cyano: $-\text{CN}$	broad spectrum of mixtures with different polarities, peptides, proteins
diol: $-\text{CHOH}-\text{CH}_2-\text{OH}$	complex mixtures
<b>reverse phase</b>	
C2 (or RP-2): $-\text{Si}-\text{CH}_2-\text{CH}_3$	purification
C8 (or RP-8): $-\text{Si}-(\text{CH}_2)_7-\text{CH}_3$	general purpose
C18 (or RP-18): $-\text{Si}-(\text{CH}_2)_{17}-\text{CH}_3$	general purpose

A longer carbon chain means a less polar stationary phase and a higher retention of non-polar solutes



# HPLC applications

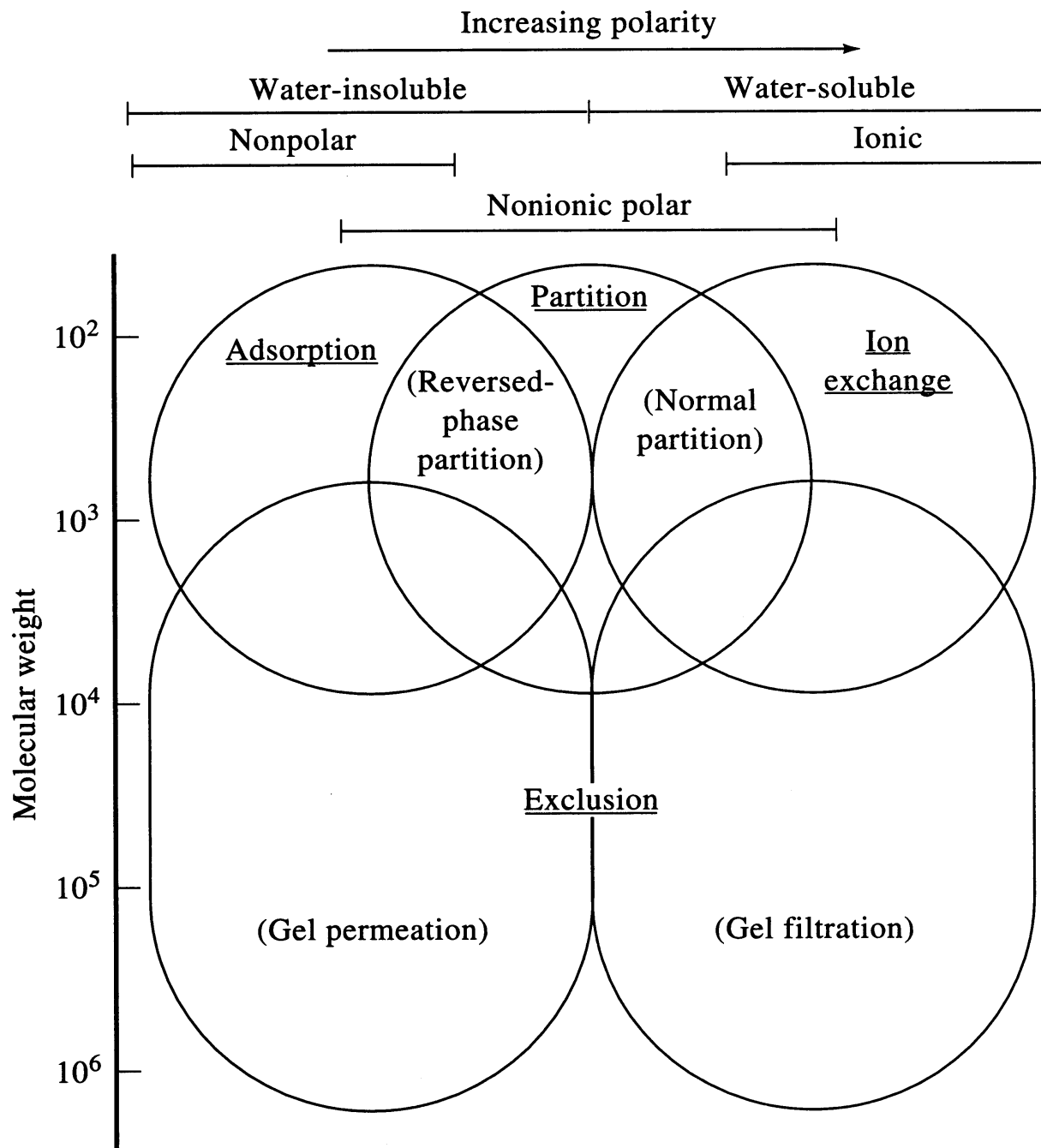

## Typical applications of HPLC chromatography

<b>Field of Application</b>	<b>Separation</b>
Pharmaceuticals	Antibiotics, Sedatives, Steroids, Analgesics
Biochemical	Amino acids, Proteins, Carbohydrates, Lipids
Food Products	Artificial Sweeteners, Antioxidants, Preservatives
Industrial Chemicals	Condensed Aromatics, Surfactants, Propellants, Dyes
Forensic Chemistry	Drugs, Poisons, Blood Alcohol, narcotics
Clinical Medicine	Bile Acids, Drug Metabolites, Urine Extracts, Estrogens
Pollutants	Pesticides, Herbicides, Phenols, PCBs

# Which separation technique for which compound ?

