

Fundamentals of Organic Chemistry

CHEM 109

For Students of Health Colleges

Credit hrs.: (2+1)

King Saud University

College of Science, Chemistry Department

Learning Objectives

2

At the end of this chapter, students will be able to:

- Identify the different types of aliphatic hydrocarbons (alkanes, cycloalkanes, alkenes, cycloalkenes and alkynes).
- Recognize the basic properties (structure, physical and chemical properties) of alkanes, alkenes and alkynes.
- Identify the structure of a hydrocarbon from its IUPAC and common name.
- Identify the name from the structure of hydrocarbons
- Explain the type of isomer in organic compounds and draw the different isomer structures of the compound.
- Know the different methods for the synthesis of aliphatic hydrocarbons.
- Identify the general reactions of aliphatic hydrocarbons.

Hydrocarbons

3

- **Hydrocarbons** are Organic Compounds, which contain only the two elements **carbon** and **hydrogen**.
- **Aliphatic hydrocarbons** are subdivided into:

➤ *Saturated hydrocarbons*

- Alkanes; C_nH_{2n+2} (contain *carbon-carbon single bond*)
- Cycloalkanes: C_nH_{2n} (contain *carbon-carbon single bond in a single ring*)

Alkanes and cycloalkanes are so similar that many of their properties can be considered side by side.

➤ *Unsaturated hydrocarbons*

- Alkenes : C_nH_{2n} (contain *carbon-carbon double bond*)
- Alkynes : C_nH_{2n-2} (contain *carbon-carbon triple bond*)

Hydrocarbons

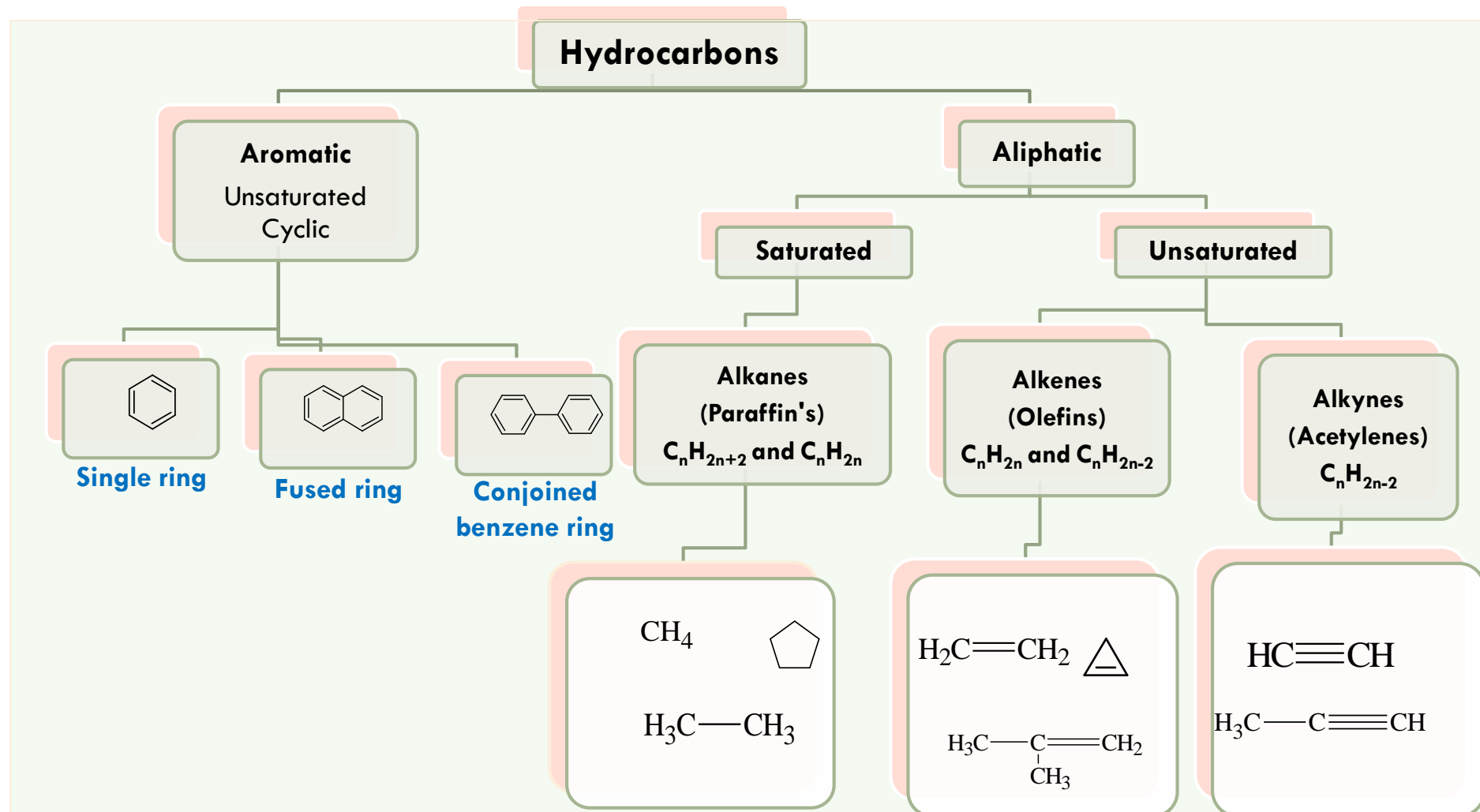



- **General formula is C_nH_{2n+2}**
- In **alkanes**, the four sp^3 orbitals of carbon repel each other into a tetrahedral arrangement with bond angles of 109.5° like in CH_4 .
- Each sp^3 orbital in carbon overlaps with the $1s$ orbital of a hydrogen atom to form a C-H bond.

Names, Molecular formulas and Number of Isomers of the first ten Alkanes

Name	Number of carbons	Molecular formula	Structural formula	Number of structural isomers
methane	1	CH_4	CH_4	1
ethane	2	C_2H_6	CH_3CH_3	1
propane	3	C_3H_8	$CH_3CH_2CH_3$	1
butane	4	C_4H_{10}	$CH_3CH_2CH_2CH_3$	2
pentane	5	C_5H_{12}	$CH_3(CH_2)_3CH_3$	3
hexane	6	C_6H_{14}	$CH_3(CH_2)_4CH_3$	5
heptane	7	C_7H_{16}	$CH_3(CH_2)_5CH_3$	9
octane	8	C_8H_{18}	$CH_3(CH_2)_6CH_3$	18
nonane	9	C_9H_{20}	$CH_3(CH_2)_7CH_3$	35
decane	10	$C_{10}H_{22}$	$CH_3(CH_2)_8CH_3$	75

Classes of Carbons and Hydrogen

6

1. Alkanes

- A **primary (1°) carbon** is one that is bonded to only one other carbon.
- A **secondary (2°) carbon** is one that is bonded to two other carbons.
- A **tertiary (3°) carbon** is one that is bonded to three other carbons.

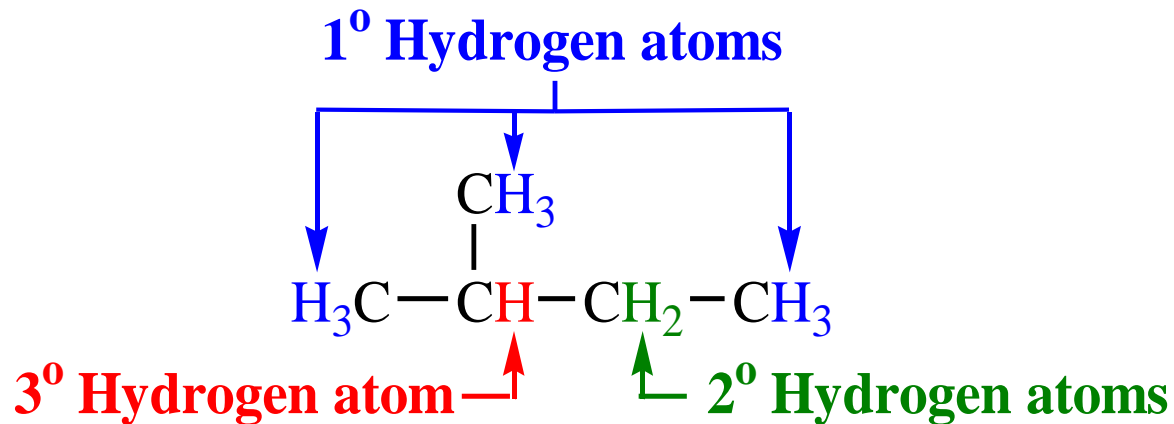

- **Hydrogens** are also referred to as 1° , 2° , or 3° according to the type of carbon they are bonded to.

Alkyl Group

- An alkyl group is formed by loss of a hydrogen atom from the corresponding alkane.
- General formula C_nH_{2n+1} .
- The letter **R** is used as a general symbol for an **alkyl group**.
- An alkyl group is named by replacing the suffix **-ane** of the parent alkane by **-yl**.

i.e. **Alkane** - **ane** + **yl** = **Alkyl**

○ Examples:

- **Derived from methane** by removing one of the hydrogens, a **one-carbon substituent** is called a **methyl group**.

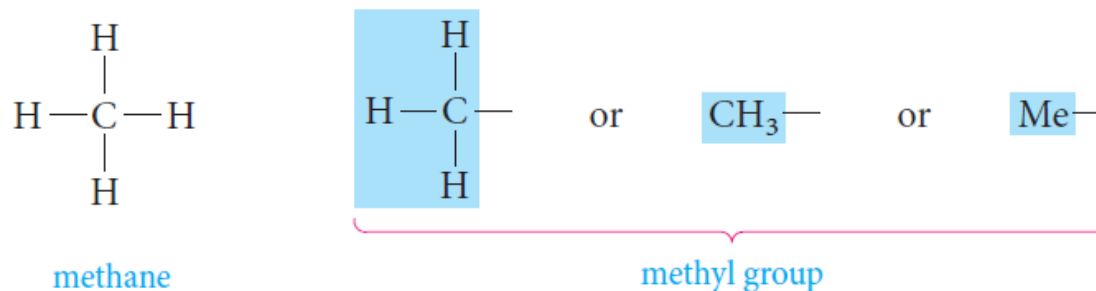

- Thus **the two-carbon alkyl group** is called the **ethyl group, from ethane**.

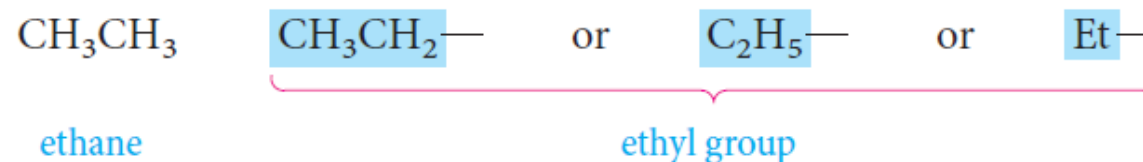

- When we come to **propane**, there are **two possible alkyl groups**, depending on which type of hydrogen is removed.
 - If a **terminal hydrogen is removed**, the group is called a **propyl group**.

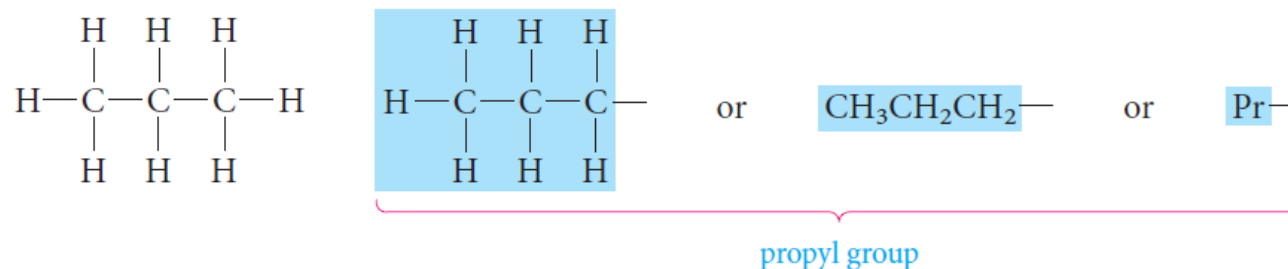

- If a **hydrogen is removed from the central carbon atom**, we get a different isomeric propyl group, called the **isopropyl group**.

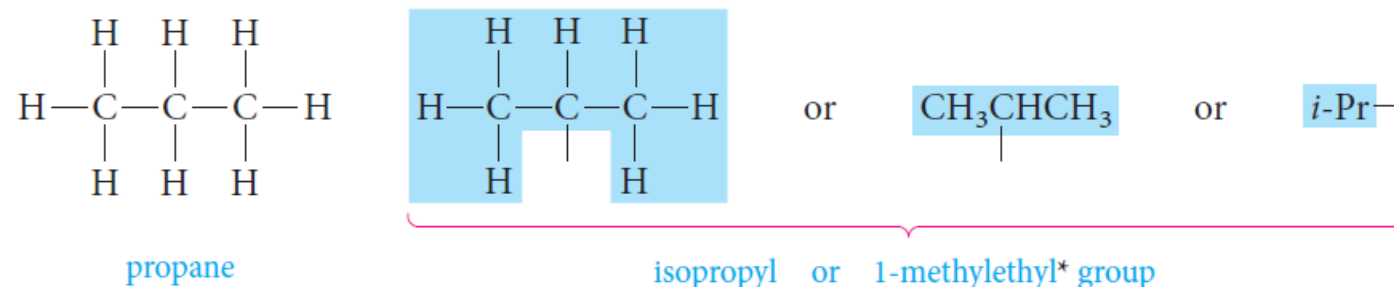

Alkyl Group

Nomenclature



10

- For **four-carbon alkyl group**, there are **four different butyl groups**.
 - The **butyl** and **sec-butyl** groups are based on ***n*-butane**.
 - The **isobutyl** and **tert-butyl** groups come from **isobutane**.

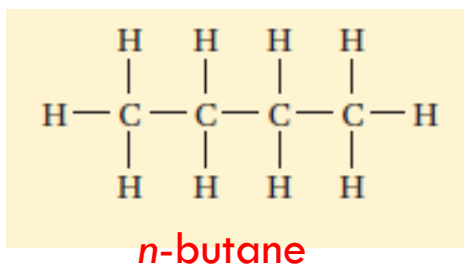

butyl

and



sec-butyl
(or 1-methylpropyl)

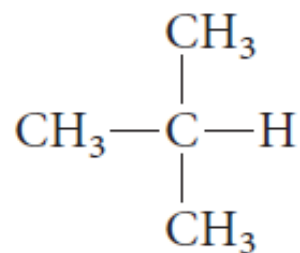

isobutane

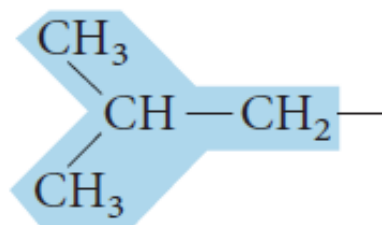

isobutyl
(or 2-methylpropyl)

and

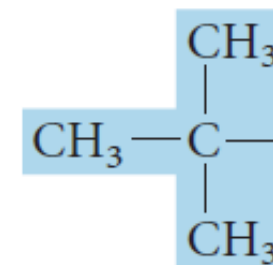

tert-butyl
(or 1,1-dimethylethyl)

1. Alkanes

Nomenclature; IUPAC Rules

11

- The older unsystematic names, (Common names).
- The IUPAC names.

International Union of Pure & Appplied Chemistry

The IUPAC Rules

- 1) Select the parent structure; the longest continuous chain

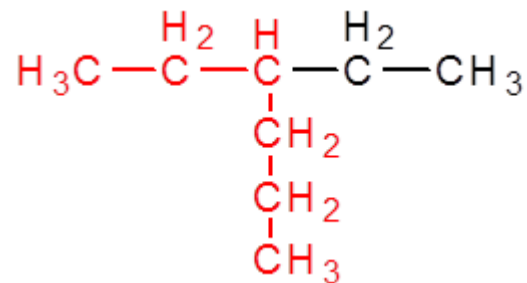

Ethylhexane

not

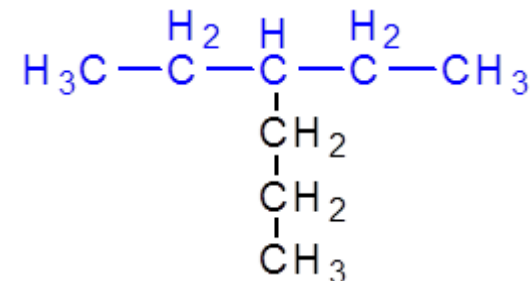

Propylpentane

X

The *longest continuous* chain is *not* necessarily *straight*.

1. Alkanes

Nomenclature; IUPAC Rules

12

2) Number the carbons in the parent chain

starting from the end which gives the lowest number for the substituent

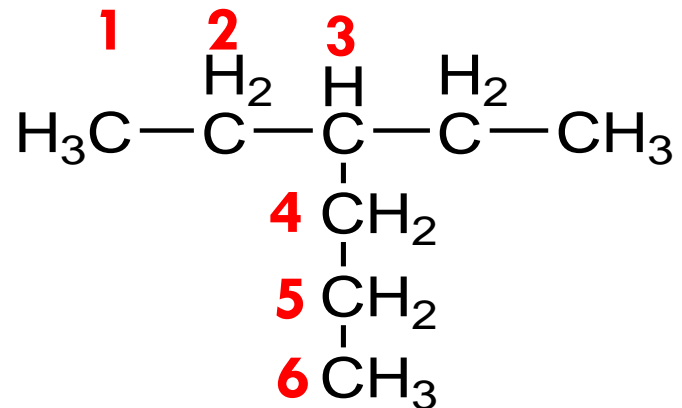

3-Ethyl hexane

not

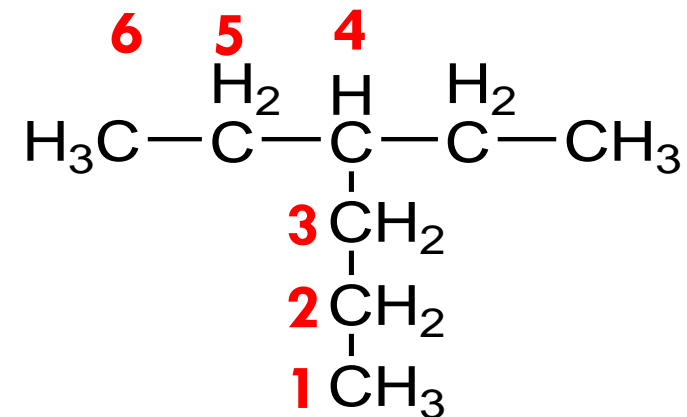

4-Ethyl hexane

X



1. Alkanes

Nomenclature; IUPAC Rules

13

2) Number the carbons in the parent chain

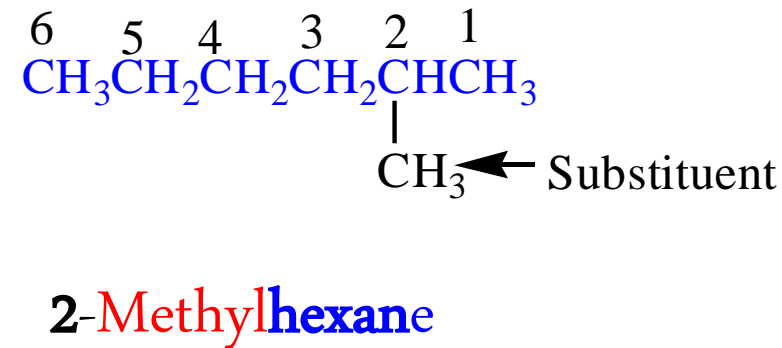
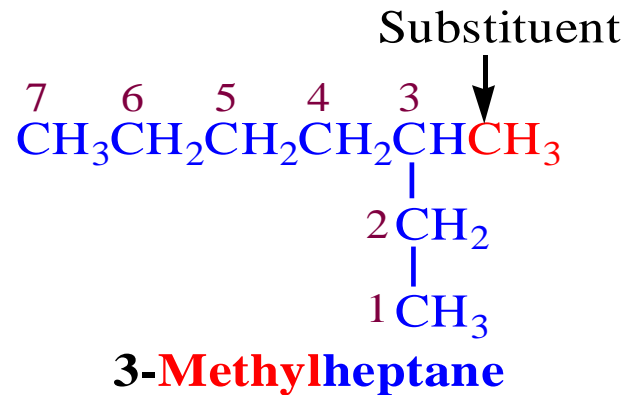

To name the compound;

- 1) Determine The position of the substituent on the parent carbon chain by a number.
- 2) The number is followed by a hyphen (-)
- 3) The combined name of the substituent (ethyl).
- 4) The parent carbon chain (hexane), So the full name will be: **3 - Ethyl hexane**



Nomenclature; IUPAC Rules

1. Alkanes

16

5) When **two substituent** are present on the same carbon, **use the number twice**.

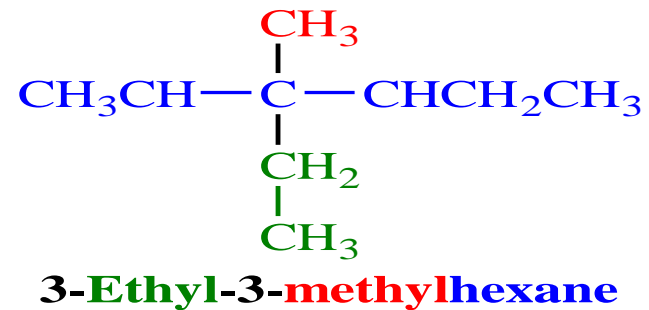

6) When two chains of equal length compete for selection as the parent chain, **choose the chain with the greater number of substituents**.

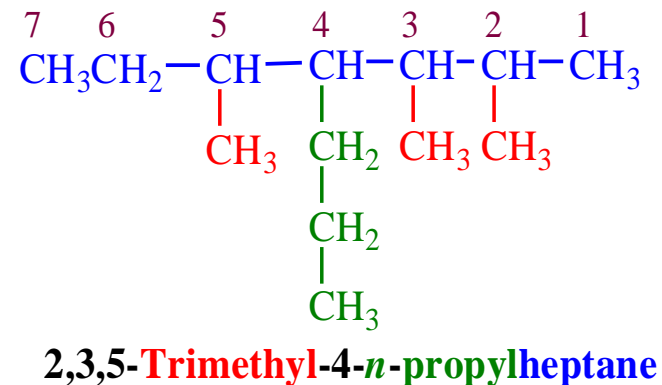

Nomenclature; IUPAC Rules

1. Alkanes

17

7) If **substituents other than alky groups** are also presents on the parent carbon chain; all substituents are named alphabetically.

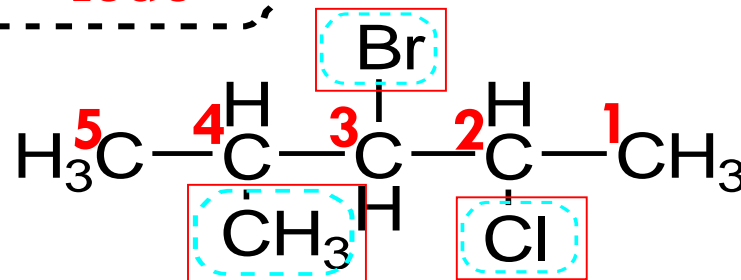
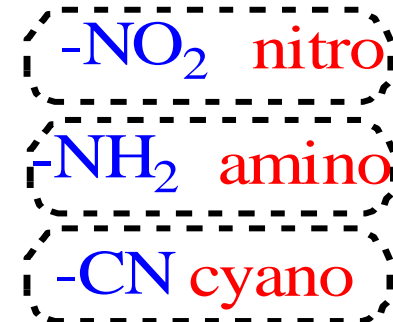
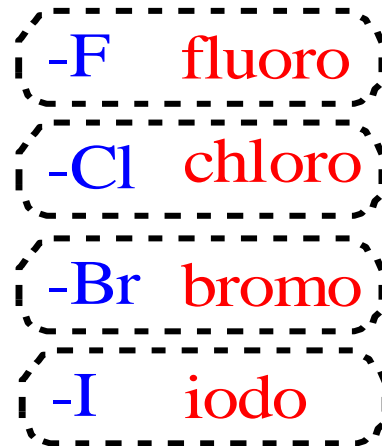

2-chloro
3-bromo
4-methyl

3-bromo -2-chloro -4-methyl pentane

Nomenclature; IUPAC Rules

1. Alkanes

Examples

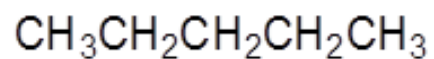

Common name:

n-Pentane

IUPAC name:

Pentane

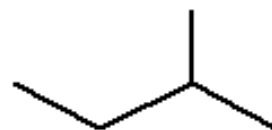
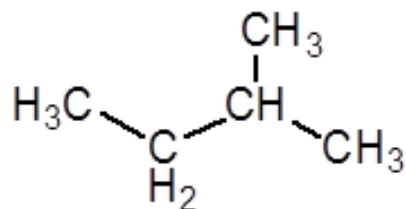

Isopentane

2-Methylbutane

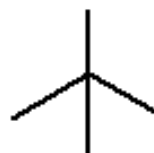
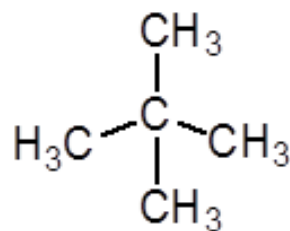

Neopentane

2,2-Dimethylpropane

Nomenclature of Cycloalkanes

1. Alkanes

- **Cycloalkanes** are saturated hydrocarbons that have at least one ring of carbon atoms.
- **Cycloalkanes** are named by placing the prefix **cyclo-** before the alkane name that corresponds to the number of carbon atoms in the ring.

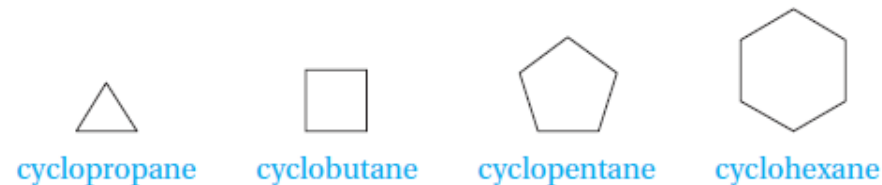

- If only one substituent is present, no number is needed to locate it.
- **If there are several substituents, numbers are required.**

With different substituents, the one with highest alphabetic priority is located at carbon 1.

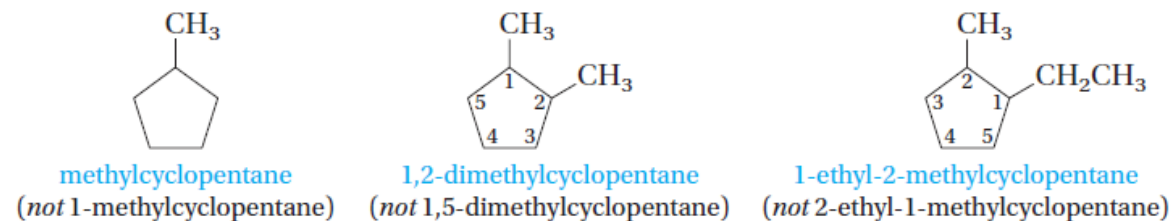

Nomenclature of Cycloalkanes

1. Alkanes

- If there are more than two substituents on the ring, they are cited in alphabetical order.
- The substituent given the number 1 position is the one that results in a second substituent getting as low a number as possible.
- If two substituents have the same low number, the ring is numbered in the direction that gives the third substituent the lowest possible number.
- **Examples,**

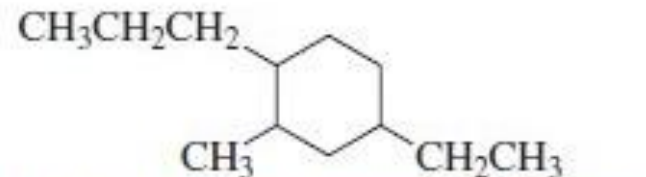

4-ethyl-2-methyl-1-propylcyclohexane

not

1-ethyl-3-methyl-4-propylcyclohexane

because 2 < 3

not

5-ethyl-1-methyl-2-propylcyclohexane

because 4 < 5

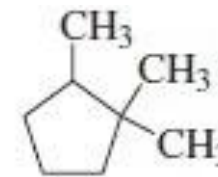

1,1,2-trimethylcyclopentane

not

1,2,2-trimethylcyclopentane

because 1 < 2

not

1,1,5-trimethylcyclopentane

because 2 < 5



Physical Properties of Alkanes, Alkenes and Alkynes

21

Those properties that can be observed without the compound undergoing a chemical reaction such as its physical states, density, color, Boiling and melting points and solubility.

A. Physical States

C1 (C2) to C4 are gases,

C5 to C17 are liquids,

C18 and larger alkanes are wax –like solids.

B. Solubility

- Alkanes, Alkenes and Alkynes are **nonpolar** compounds.
- Their solubility “ **Like dissolve like**”
- Alkanes, Alkenes and Alkynes are **soluble** in the **nonpolar solvents**;
carbon tetrachloride, CCl_4 and benzene,
- Alkanes, Alkenes and Alkynes are **insoluble** in **polar solvents** like **water**.



Physical Properties of Alkanes, Alkenes and Alkynes

○ Boiling Points & Melting Points

■ Effect of Molecular Weight

The boiling points and melting points of **normal hydrocarbons** increase with increasing molecular weight.

As the molecules become larger, there are more forces of attraction between them, and more energy is needed.

■ Effect of Branching

- **Among isomers**, straight chain compound has the highest boiling point.
- The greater the number of branches, the lower the boiling point.

Name	Formula	Boiling point, °C
pentane	$\text{CH}_3\text{CH}_2\text{CH}_2\text{CH}_2\text{CH}_3$	36
2-methylbutane (isopentane)	$\begin{array}{c} \text{CH}_3\text{CHCH}_2\text{CH}_3 \\ \\ \text{CH}_3 \end{array}$	28
2,2-dimethyl- propane (neopentane)	$\begin{array}{c} \text{CH}_3 \\ \\ \text{CH}_3 - \text{C} - \text{CH}_3 \\ \\ \text{CH}_3 \end{array}$	10

Preparation of Alkanes

1. Alkanes

23

1. Hydrogenation of unsaturated hydrocarbon:

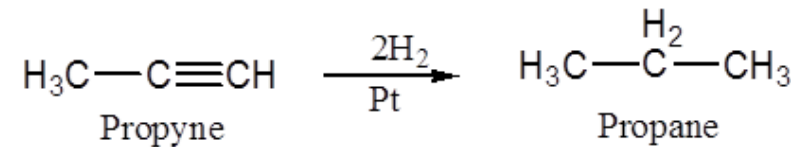
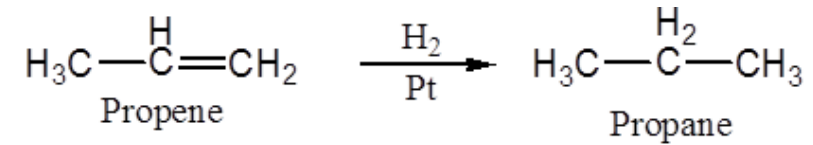

2. Hydrolysis of Grignard reagent

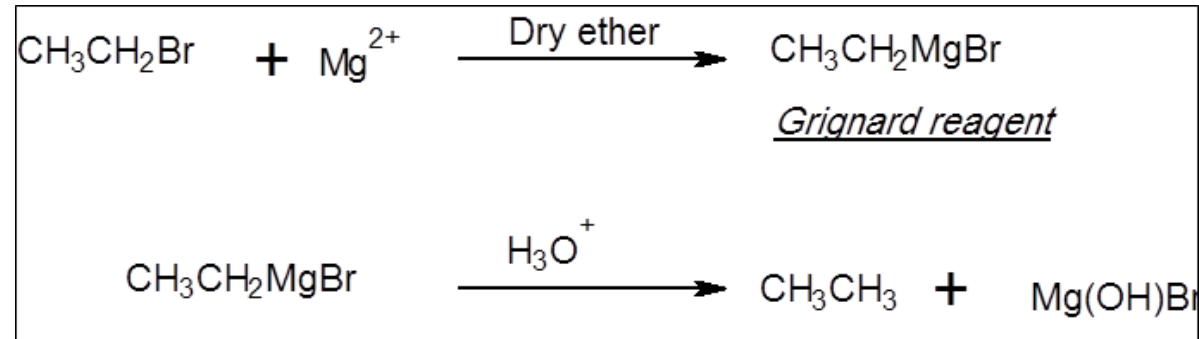

3. Reduction of Alkyl halides By lithium dialkyl cuprate

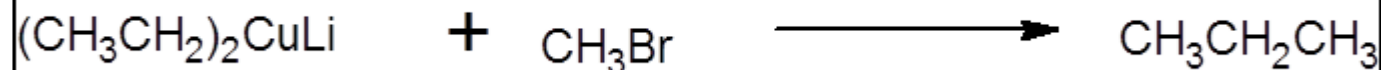

Reactions of Alkanes

24

Saturated hydrocarbons undergo very few reactions, so they are called **Paraffinic hydrocarbons**. (Latin *parum*, little; *affinis*, affinity)

Combustion

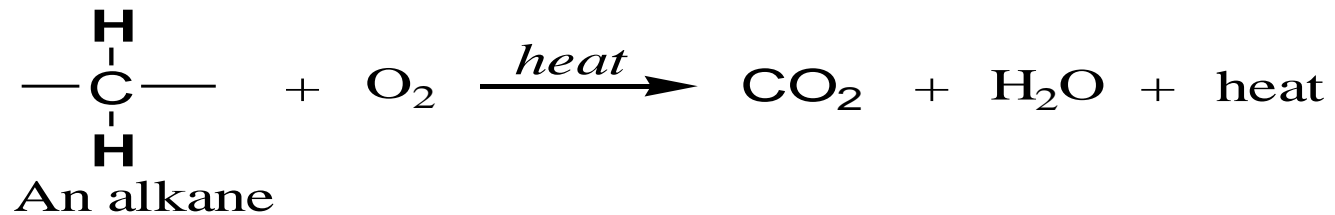

Halogenation

The halogenation of an alkane appears to be a simple free radical substitution in which a C-H bond is broken and a new C-X bond is formed

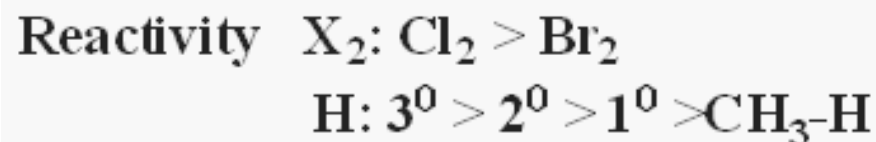



1. Alkanes

Reactions of Alkanes

25

A. Halogenation

- **Substitution reaction of alkanes,**
i.e. replacement of hydrogen by halogen,
usually chlorine or bromine, giving alkyl chloride or alkyl bromide.
- **Flourine reacts explosively with alkanes**
It is unsuitable reagent for the preparation of the alkyl flourides.
- **Iodine is too unreactive**
It is not used in the halogentaion of alkanes.
- **Halogenation of alkanes take place at**
high temperatures or under the influence of **ultraviolet light**

Reactions of Alkanes

A) Halogenation

- Chlorination of an alkane usually gives a mixture of products

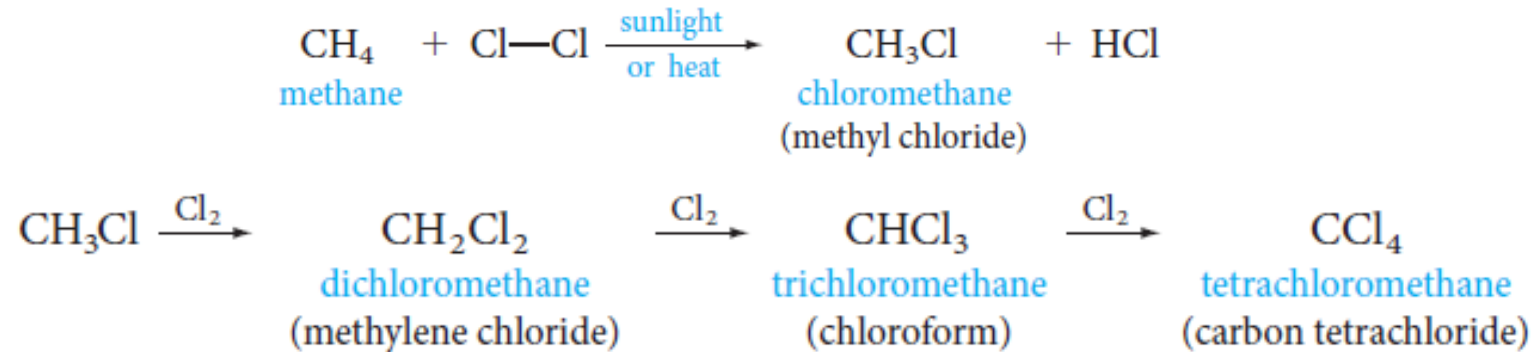

- With longer chain alkanes, mixtures of products may be obtained even at the first step. For example, with propane,

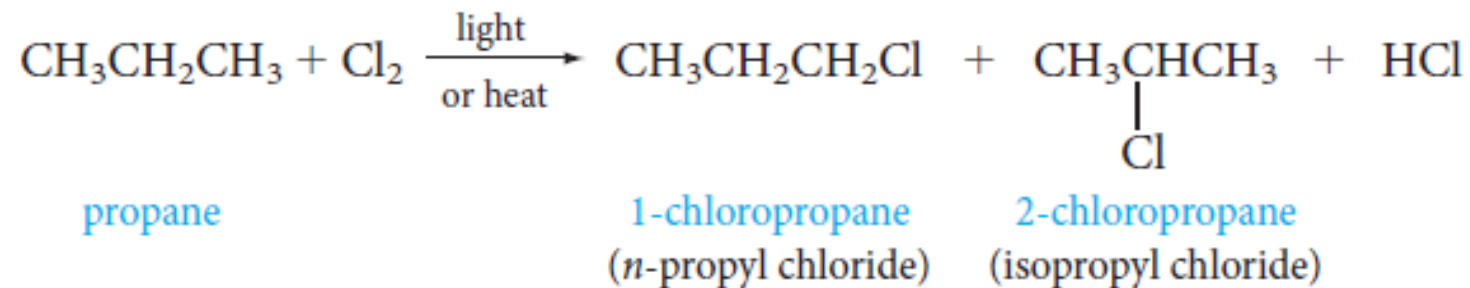

Uses of Alkanes

27

- **Alkanes** are unreactive compounds and mainly used as a source of energy;

Examples:

- Natural gas is composed mostly of methane, but it also contains small amounts of ethane, propane, butane, and pentane.
- Diesel itself is a mixture of hydrocarbons, ranging from $C_{10}H_{20}$, (decane) to $C_{15}H_{28}$.
- **Petroleum jelly (Vaseline)** is petrolatum, a hydrocarbon, $C_{15}H_{15}N$ (1,1,2 Trimethylbenzeindole).
- Most petroleum jelly today is used as an ingredient in skin lotions and cosmetics.
- **Paraffin wax (or petroleum wax)** is a soft colorless solid, derived from petroleum, that consists of a mixture of hydrocarbon molecules containing between twenty and forty carbon atoms.
- Common applications for paraffin wax include lubrication, electrical insulation, and candles
- **Cyclopropane** is used as an anaesthetic
- **General uses;**
 - Making organic compounds and used as Organic solvents



2. ALKENES



1. Alkenes

The Structure of Alkenes

29

- **Alkenes** are hydrocarbons that contain a **carbon-carbon double bond**.
- **Alkenes** are also **Olefins**.
- **General formula** is C_nH_{2n}
- The simplest members of the **Alkenes** series are **C₂ & C₃**

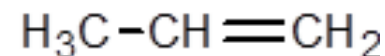
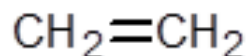

Common name: Ethylene

Propylene

IUPAC name: Ethene

Propene

- Hybridization; **sp²-hybridized orbitals**
- The angle between them is **120°** and bond length C=C (1.34 Å).
- A **trigonal planar**.



1. Alkenes

Nomenclature; Common Names

30

- The simplest members of the alkene and alkyne series are frequently referred to by their older common names, ethylene, acetylene, and propylene.

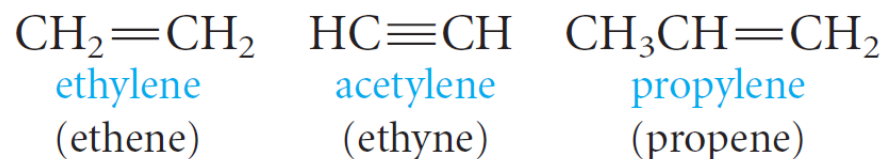

- Two important groups also have common names; They are the **vinyl** and **allyl** groups.
- These groups are used in common names.

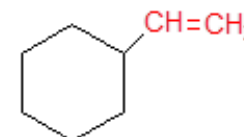
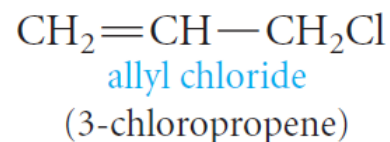
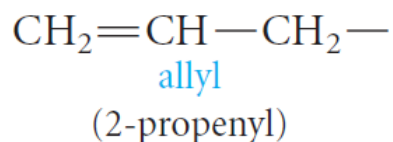
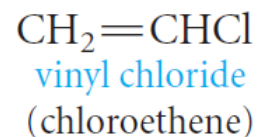
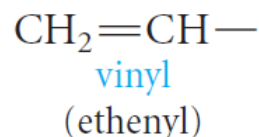

Common name: **Vinyl** cyclohexane
IUPAC name: Cyclohexylethene

1. Alkenes

Nomenclature; IUPAC Rules

31

The IUPAC rules for naming alkenes are similar to those for alkanes, but a few rules must be added for naming and locating the multiple bonds.

1. The ending **-ene** is used to designate a carbon–carbon double bond.
2. Select the **longest chain that includes both carbons of the double bond**.

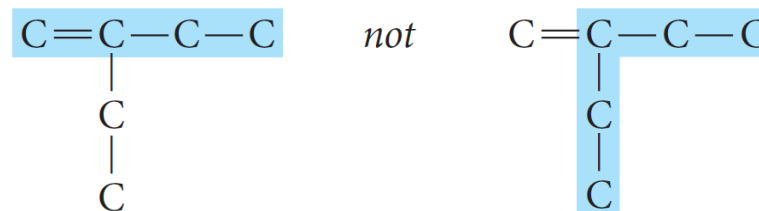

3. **Number the chain from the end nearest the double bond** so that the carbon atoms in that bond have the lowest possible numbers.

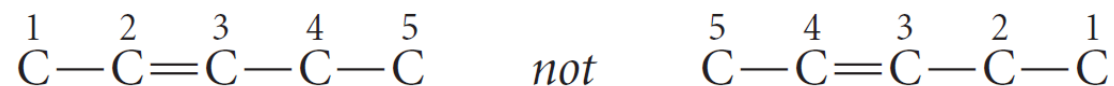



1. Alkenes

Nomenclature; IUPAC Rules

32

If the multiple bond is equidistant from both ends of the chain, number the chain from the end nearest the first branch point.

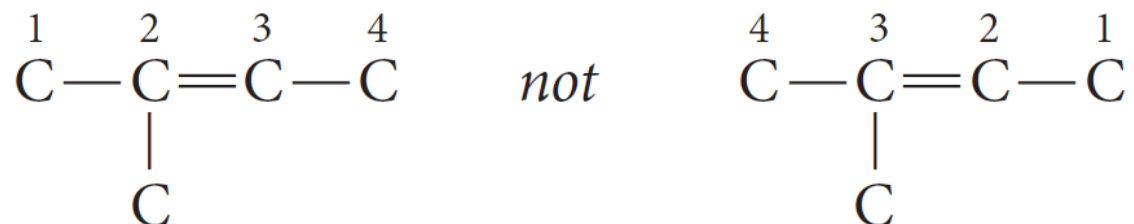

4. Indicate the **position of the multiple bond using the lower numbered carbon atom** of that bond.



Nomenclature; IUPAC Rules

33

NOTES

The root of the name (*eth-* or *prop-*) tells us the number of carbons, and the ending (*-ane*, *-ene*, or *-yne*) tells us whether the bonds are single, double, or triple.

No number is necessary in these cases, because in each instance, only one structure is possible.

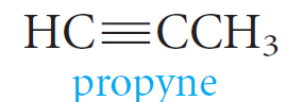
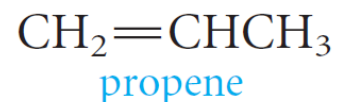
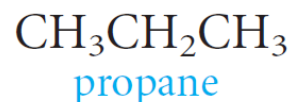
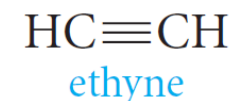
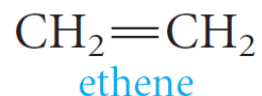

With four carbons, a number is necessary to locate the double bond.

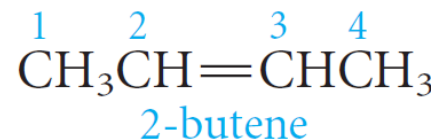
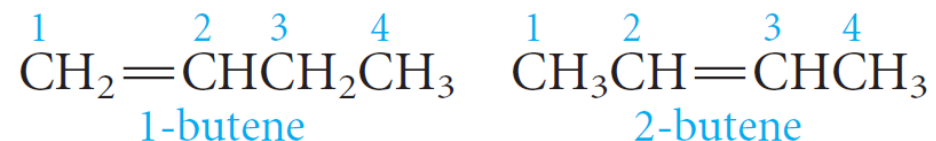



1. Alkenes

Nomenclature; IUPAC Rules

34

- Branches are named in the usual way.

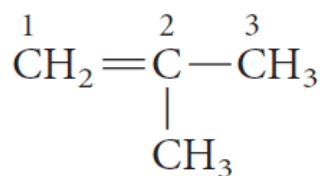

methylpropene
(isobutylene)

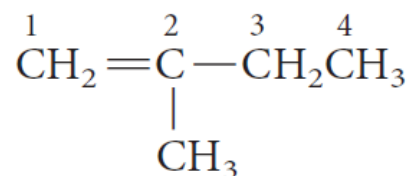

2-methyl-1-butene

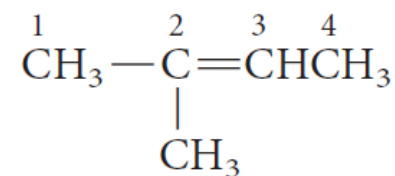

2-methyl-2-butene

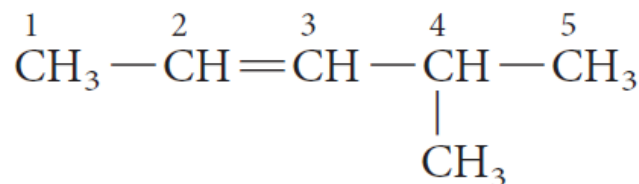

4-methyl-2-pentene
(Not 2-methyl-3-pentene;
the chain is numbered so
that the double bond gets
the lower number.)

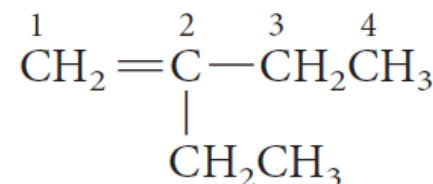

2-ethyl-1-butene
(Named this way,
even though there
is a five-carbon
chain present,
because that chain
does not include
both carbons of the
double bond.)

1. Alkenes

Nomenclature; IUPAC Rules

Example: Write the structural formula of **4-Isopropyl-3,5-dimethyl-2-octene**.

1) The parent carbon chain is an **Octene**.

The double bond is located between the 2nd and 3rd carbons.

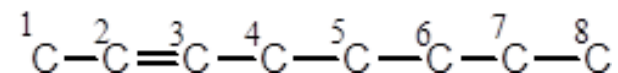

2) Two **methyl groups** are attached on the parent carbon chain, one on **carbon 3** and the other on **carbon 5**

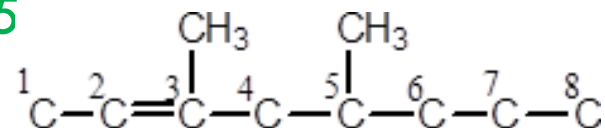

3) An **isopropyl group** is attached on **carbon 4**.

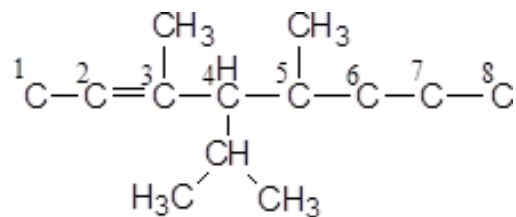

4) Put the missing hydrogens to get the correct structure.

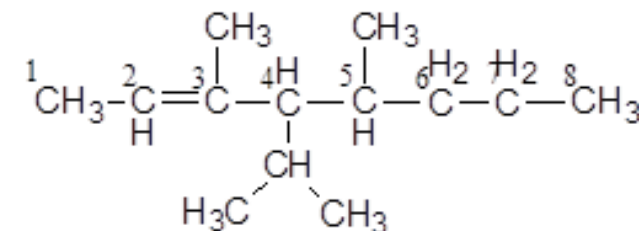

1. Alkenes

Nomenclature of Cycloalkenes

- We start numbering the ring with the carbons of the double bond.
- A number is not needed to denote the position of the functional group, because the ring is always numbered so that the double bond is between carbons 1 and 2.
- Put the lowest substituent number into the name not in the direction that gives the lowest sum of the substituent numbers.

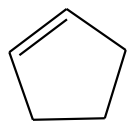

Cyclopentene

~~2-Cyclopentene~~

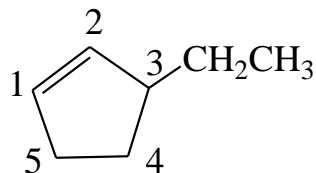

3-Ethylcyclopentene

~~5-Ethylcyclopentene~~

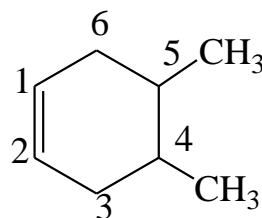

4,5-Dimethylcyclohexene

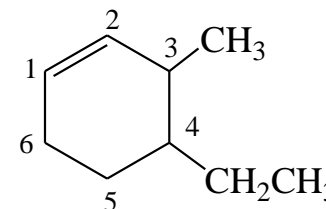

4-Ethyl-3-methylcyclohexene

- **Isomers** are different compounds with identical molecular formulas.
- The phenomenon is called **isomerism**.

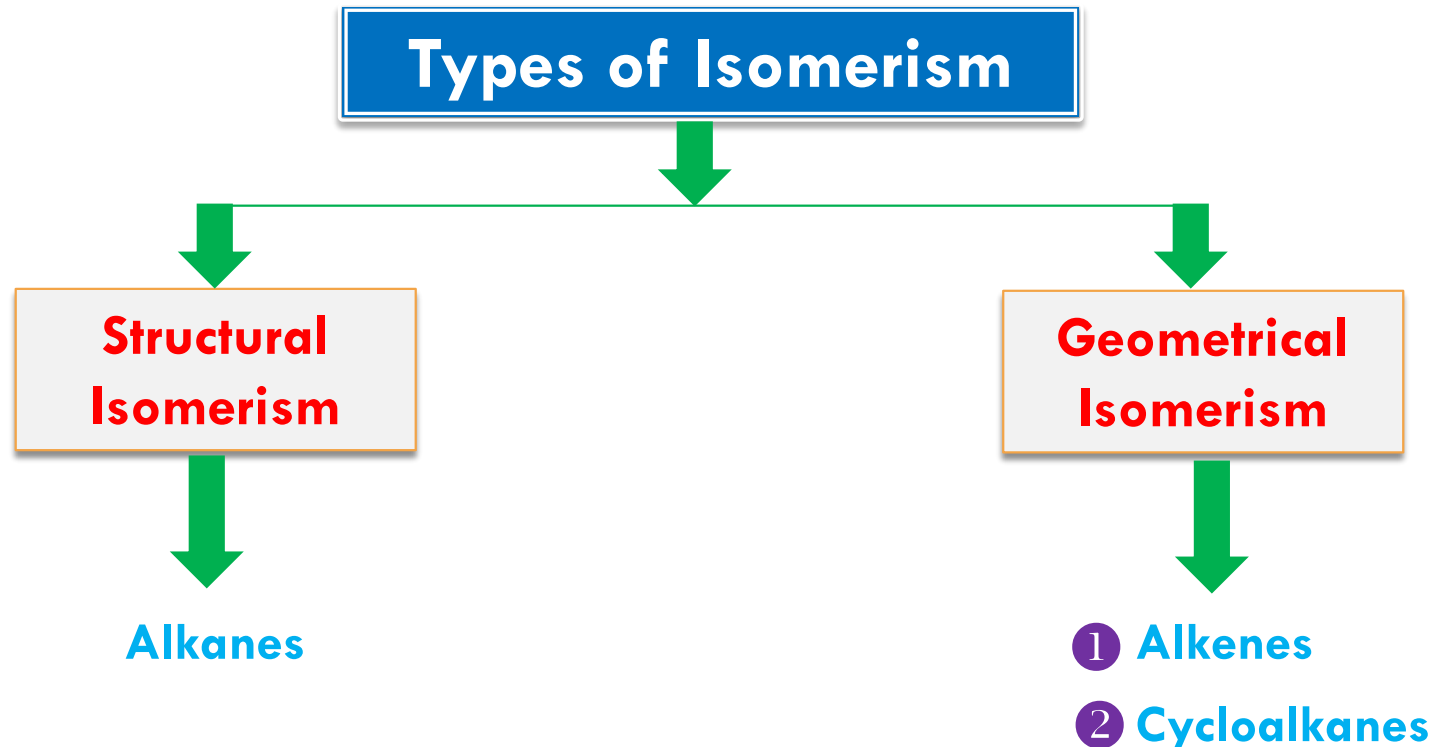

Structural Isomerism in Alkanes

38

- **Structural** or **constitutional isomers** are isomers which differ in the sequence of atoms bonded to each other.
 - **Examples:**

- **Butanes, C_4H_{10}**

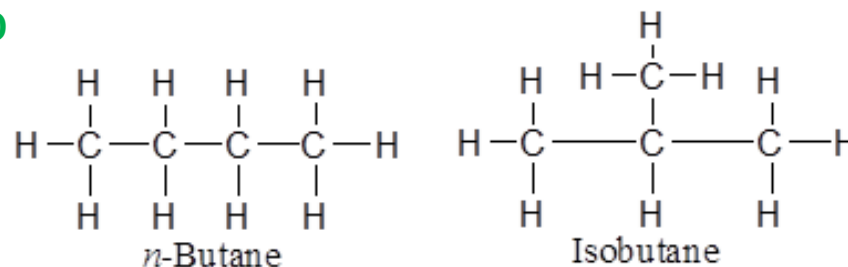

- **Pentanes, C_5H_{12}**

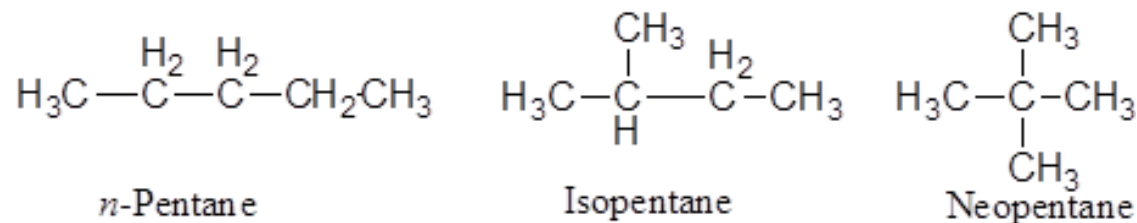

Geometric Isomerism in Alkenes

39

- In **alkenes**, **geometric isomerism** is due to **restricted rotation** about the **carbon - carbon double bond**.



Geometric isomers

A) when W differs from X and Y from Z, Alkenes exist as **geometric isomers**

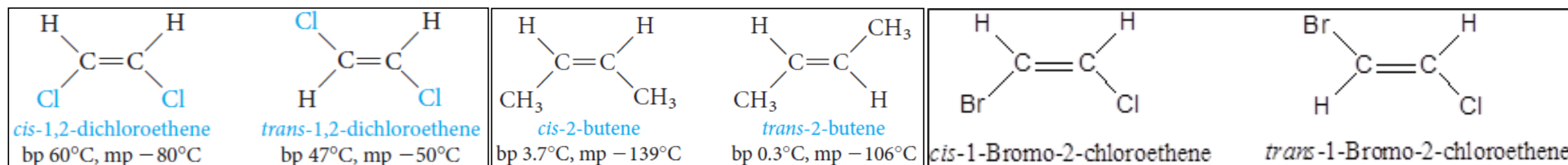

- cis isomer***; when two similar groups are on the **same side** or **same side** of the double bond.
 - trans isomer***; when two similar groups are on the **opposite direction** or **opposite sides** of the double bond.
- They have **different physical properties** and can be separated by **fractional crystallization** or **distillation**.

Geometric Isomerism in Alkenes

40

B) If ($W = X$ or $Y = Z$), geometric isomerism is not possible.

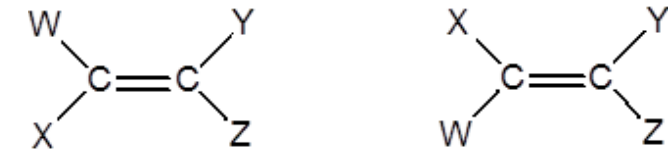

Geometric isomers

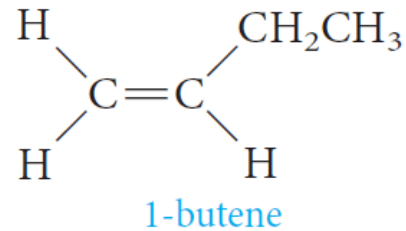

is identical to

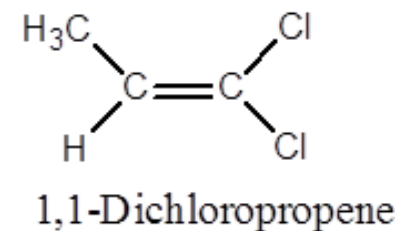
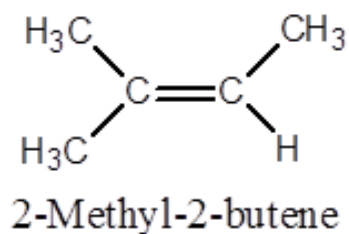
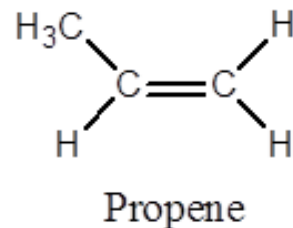
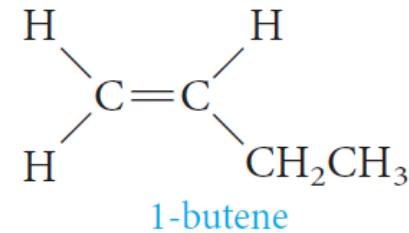

Geometric Isomerism in Alkenes

41

- For alkenes with four different substituent such as

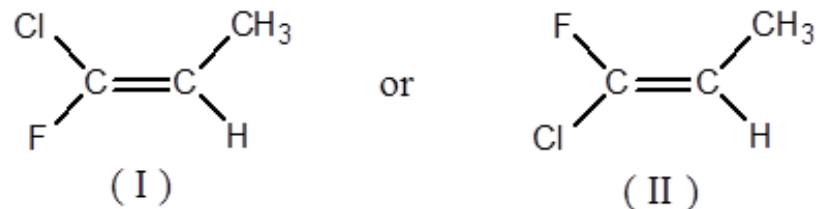

Another system, the **E, Z** system,

- Basically, **the E, Z system** works as follows;

Arrange the groups on each carbon of the C=C bond in order of priority

- **The priority depends on atomic number:**

*The **higher the atomic number** of the atom directly attached to the double-bonded carbon, **the higher the priority.***

Thus, in structure (I),



Geometric Isomerism in Alkenes

42

- If the two groups of **higher priority** are on the **same side** of the C=C plane, The isomer is labeled **Z**; (from the German *zusammen*, together).
- If the two groups of higher priority are on **opposite sides** of the C=C plane, The isomer is labeled **E**; (from the German *entgegen*, opposite).

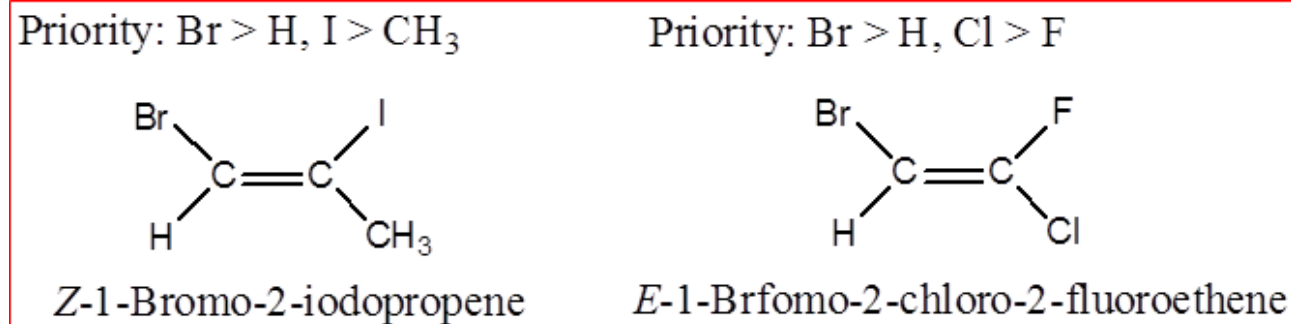
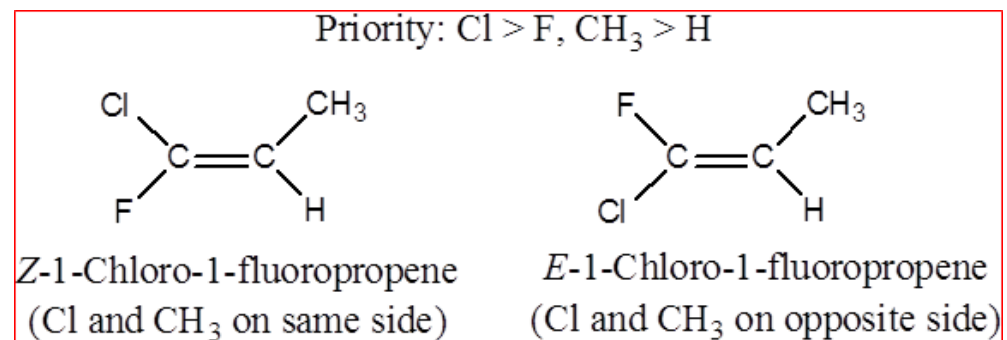

Geometric Isomerism in Cycloalkanes

43

cis-trans Isomerism in Cycloalkanes

cis-trans isomerism (sometimes called geometric isomerism) is one kind of stereoisomerism.

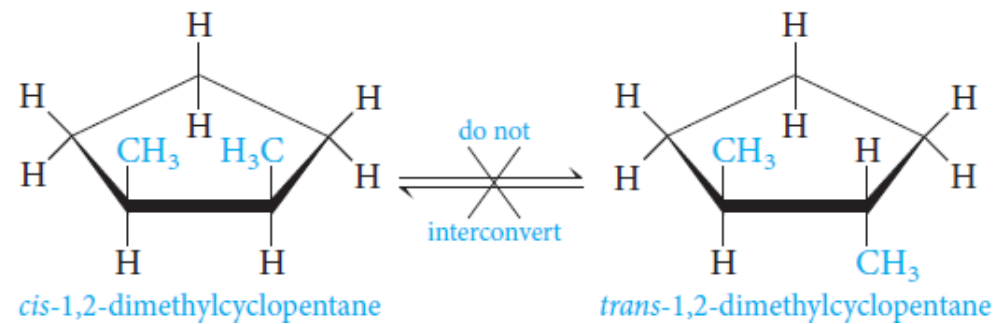
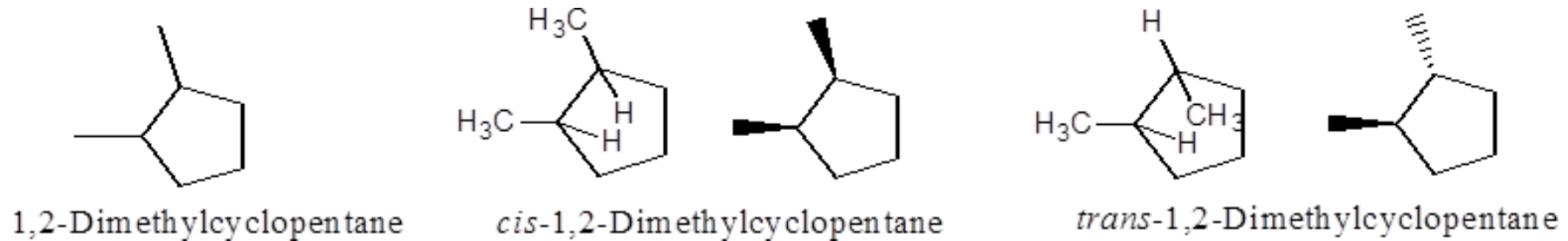

Preparation of Unsaturated hydrocarbons

- **Unsaturated hydrocarbons** are prepared by **Elimination** of an atom or group of atoms from adjacent carbons to form **carbon-carbon double or triple bond**.

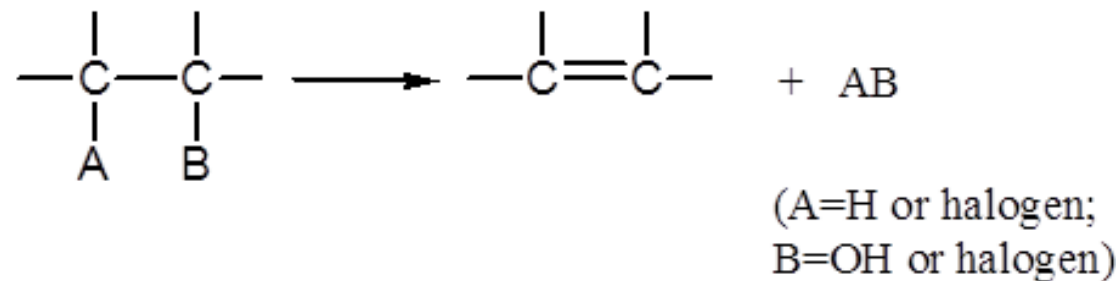

1) Dehydration of Alcohols

When an alcohol is heated in the presence of a mineral acid catalyst, It readily loses a molecule of **water** to give an **alkene**.

Preparation of Unsaturated hydrocarbons (Alkenes)

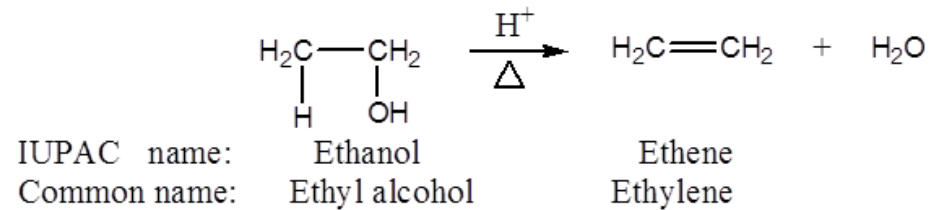

The acid catalysts most commonly used are mineral acids as **sulfuric acid, H_2SO_4 , and phosphoric acid, H_3PO_4 .**

- Removal of OH group and a proton from two adjacent carbon atoms using mineral acids such as HCl, H_2SO_4 and H_3PO_4

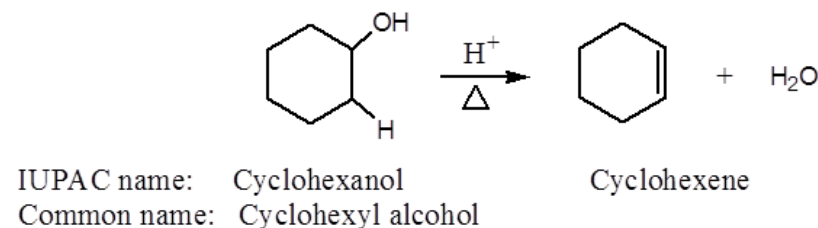
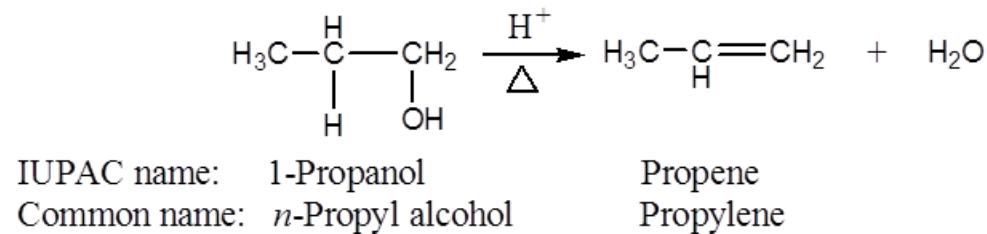

Preparation of Unsaturated hydrocarbons (Alkenes)

1) Dehydration of Alcohols

46

Which Alkene Predominates?; Saytzeff's Rule

The loss of water from adjacent carbon atoms, can give rise to *more than one alkene*.

Example: the dehydration of 2-butanol.

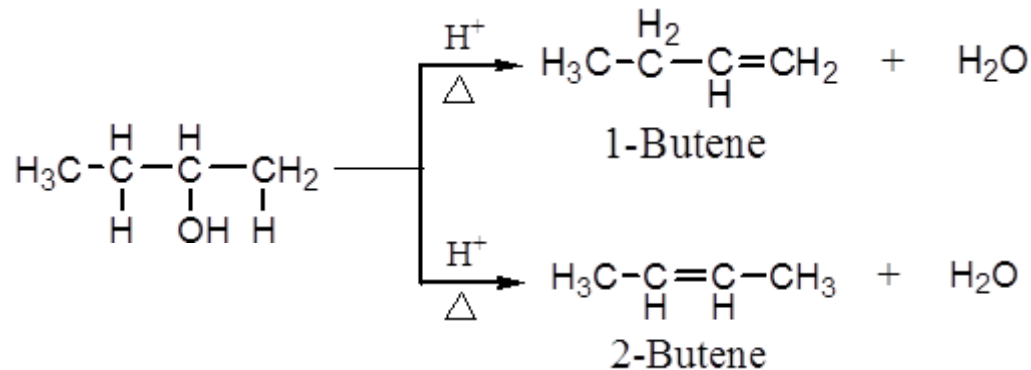

2-butene is the major (with two alkyl substituents attached to C=C)

Saytzeff's Rule applies

In every instance in which more than one **Alkene** can be formed

The major product is always the alkene with the most alkyl substituents attached on the double-bonded carbons.

1) Dehydration of Alcohols

47

○ Classes of Carbocations

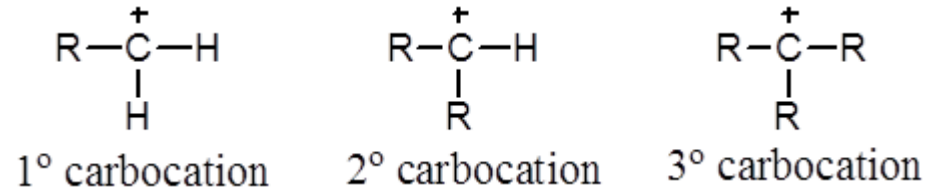

according to the number of carbon atoms attached to the positively charged carbon.

The ease of formation and the stabilities of carbocations follow the order

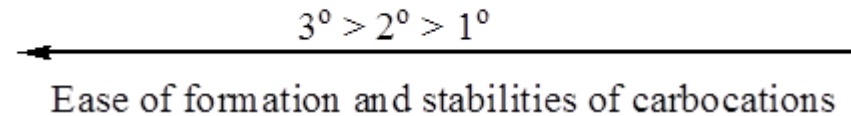

○ Generally

1. The dehydration of alcohols requires an **acid catalyst**.
2. The predominant alkene formed follows **Saytzeffs rule**.
3. The reaction proceeds *via* a **carbocation intermediate**.
4. The stabilities of carbocations and the ease of dehydration of alcohols follows the order **$3^\circ > 2^\circ > 1^\circ$** .

Preparation of Unsaturated hydrocarbons (Alkenes)

2) Dehydrohalogenation of Alkyl Halides

48

- Alkenes can also be prepared under alkaline conditions.

heating an alkyl halide with a solution of KOH or NaOH in alcohol, yields an alkene.

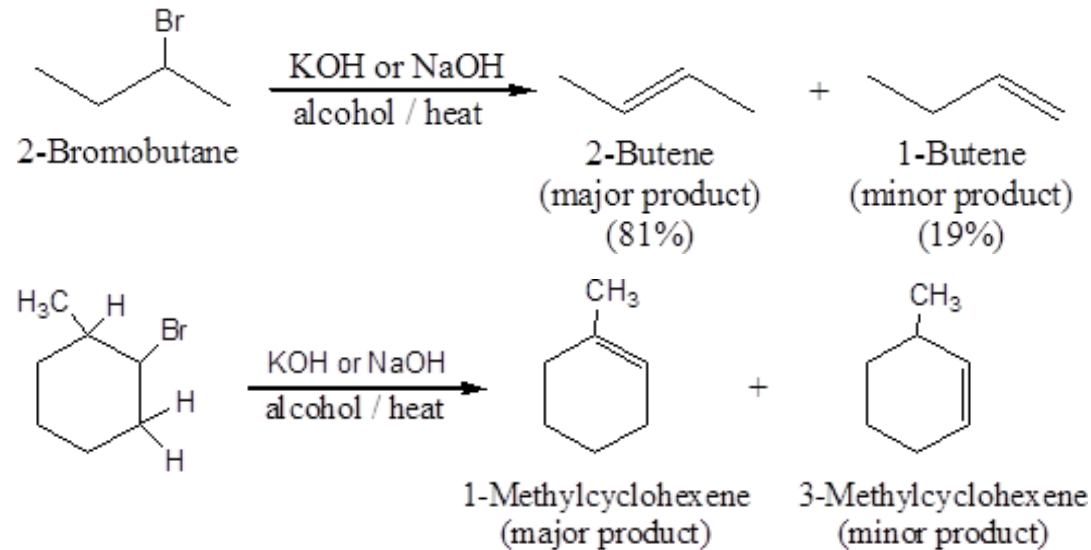

3) Dehalogenation of Vicinal Dibromides

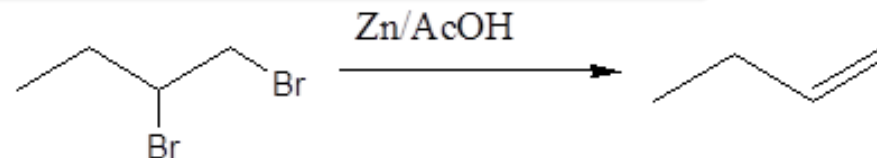

Reactions of Unsaturated hydrocarbons

(1) Electrophilic Addition Reactions

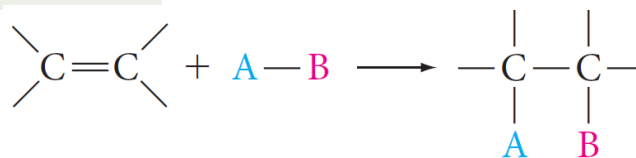

Addition of *Symmetric and Unsymmetric Reagents to symmetric Alkenes.*

1. Addition of Hydrogen: Catalytic Hydrogenation
2. Addition of Halogens: Halogenation

Addition of *Unsymmetric Reagents to Unsymmetric Alkenes; Markovnikov's Rule.*

1. Addition of Hydrogen Halides
2. Addition of Sulfuric Acid
3. Addition of Water: Hydration
4. Addition of HOX: Halohydrin Formation

(2) Oxidation Reactions

1. Ozonolysis
2. Oxidation Using KMnO_4

Electrophilic Addition Reactions

1. Addition of Hydrogen: Hydrogenation

Addition of a mole of hydrogen to carbon-carbon double bond of Alkenes in the presence of suitable catalysts to give an *Alkane*.

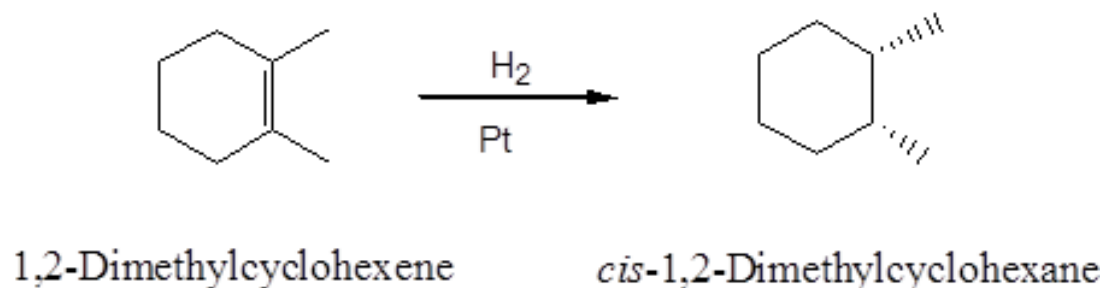
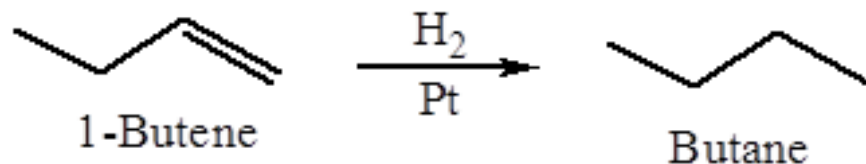

Electrophilic Addition Reactions

51

2. Addition of Halogen: Halogenation

When an **alkene** is treated at room temperature with a solution of **bromine** or **chlorine** in carbon tetrachloride to give the corresponding **vicinal dihalide** (two halogens attached to adjacent carbons)

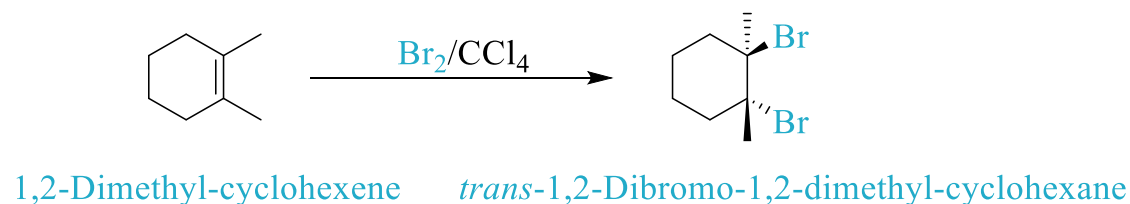
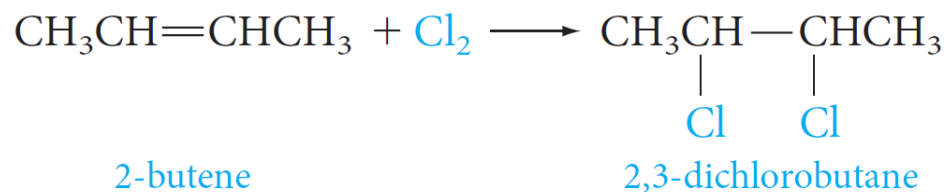

3. Addition of Acids

- A variety of acids add to the double bond of alkenes.

The hydrogen ion (or proton) adds to one carbon of the double bond, and the remainder of the acid becomes connected to the other carbon.

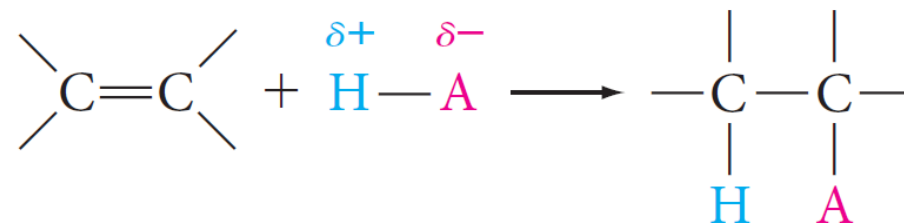

- Acids that add in this way are the **hydrogen halides** (H-F, H-Cl, H-Br, H-I), and **water** (H-OH).

Electrophilic Addition Reactions

- Any electron-deficient species is called an **electrophile**.
- Any electron-rich species is called a **nucleophile**.

Examples of Electrophile:

- Positive reagents:** protons (H^+), alkyl group R^+ , nitronium ion (NO_2^+), etc....
- Neutral reagents having positively polarized centers:** HCl , bromine (because it can be polarized so that one end is positive).
- Lewis acids:** molecules or ions that can accept an electron pair $\Rightarrow \text{BF}_3$ and AlCl_3 .

Examples of Nucleophile:

a) Negative ions

e.g. $\text{H}\ddot{\text{O}}^-$: Hydroxide ion, $\text{H}\ddot{\text{S}}^-$: Hydrosulphide ion, $\text{R}\ddot{\text{O}}^-$: Alkoxide ions,

$:\text{N}\equiv\text{C}^-$: Cyanide ion, $:\ddot{\text{X}}^-$: Halide ions, ...etc.

b) Neutral molecules

e.g. $\text{H}_2\ddot{\text{O}}$, $\text{R}-\ddot{\text{O}}-\text{H}$, $\text{R}-\ddot{\text{O}}-\text{R}$, $\text{H}_3\ddot{\text{N}}$, $\text{R}_3\ddot{\text{N}}$, ...etc.

3. Addition of Acids

- The addition of H—A to an alkene is believed to be a **two-step process**.

Step 1. The hydrogen ion (the **electrophile**) attacks the Π -electrons of the alkene, forming a C—H bond and a **carbocation**.

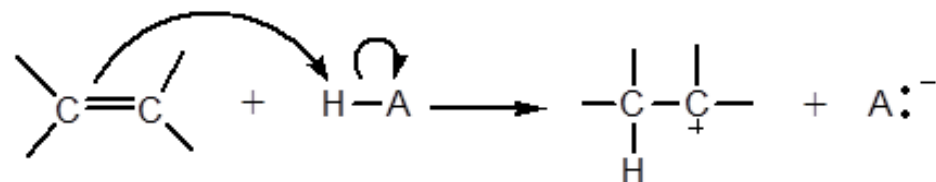

Step 2. The negatively charged species A: - (a **nucleophile**) attacks the carbocation and forms a new C—A bond.

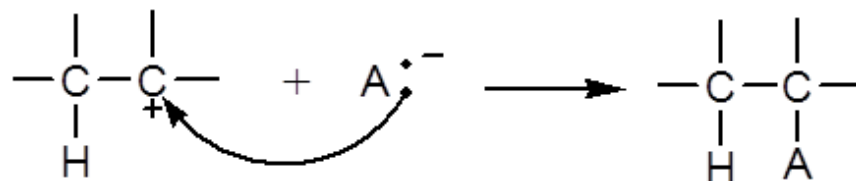

- The attack by an electrophilic reagent on the Π -electrons, falls in a general category called **electrophilic addition reactions**.

Electrophilic Addition Reactions

55

3.1. Addition of Hydrogen Halide

Alkenes react with hydrogen chloride, HCl , hydrogen bromide, HBr and hydrogen iodide, HI , to form alkyl halides, RX .

General equation

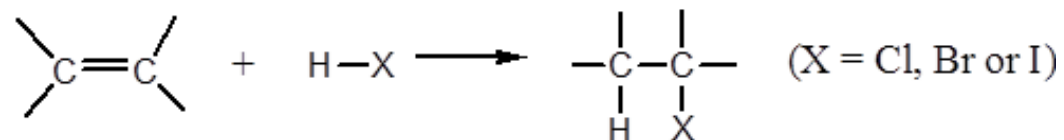

Examples;

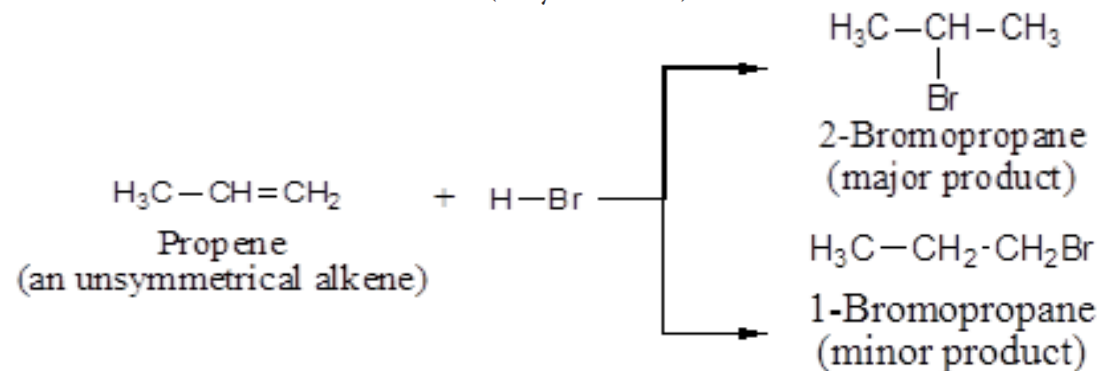
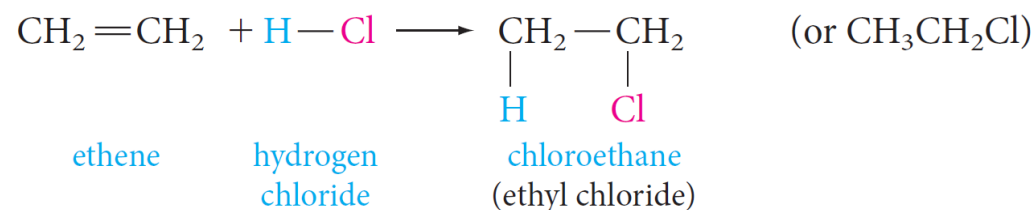

Electrophilic Addition Reactions

56

- **Reagents and alkenes can be classified as either symmetric or unsymmetric** with respect to addition reactions.
 - If a reagent and/or an alkene is symmetric, only one addition product is possible.
 - But if *both* the reagent *and* the alkene are *unsymmetric*, two products are, in principle, possible.

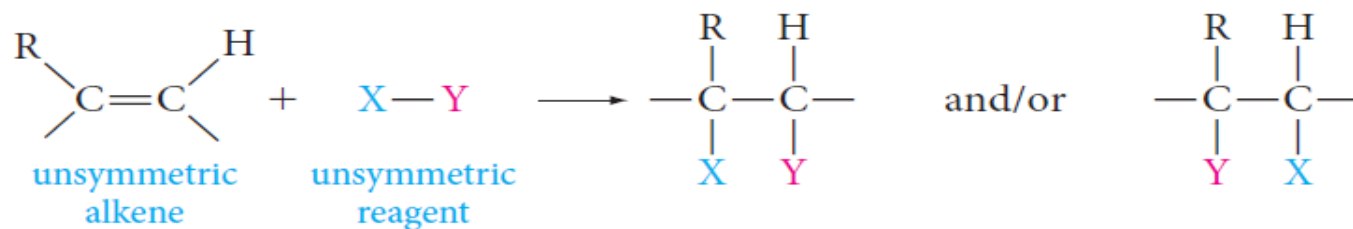

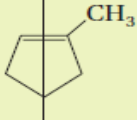

Table 3.2 Classification of Reagents and Alkenes by Symmetry with Regard to Addition Reactions

	Symmetric	Unsymmetric
Reagents	$\begin{array}{c} \text{Br}-\text{Br} \\ \text{Cl}-\text{Cl} \\ \text{H}-\text{H} \end{array}$	$\begin{array}{c} \text{H}-\text{Br} \\ \text{H}-\text{OH} \\ \text{H}-\text{OSO}_3\text{H} \end{array}$
Alkenes	$\text{CH}_2=\text{CH}_2$  <p style="text-align: center;">mirror plane</p>	$\text{CH}_3\text{CH}=\text{CH}_2$  <p style="text-align: center;">not a mirror plane</p>

Electrophilic Addition Reactions

57

Markovnikov's Rule

In electrophilic addition of $\text{H}-\text{X}$ to **Unsymmetrical Alkenes** the hydrogen of the hydrogen halide adds to the double-bonded carbon that bears the greater number of hydrogen atoms and the negative halide ion adds to the other double-bonded carbon.

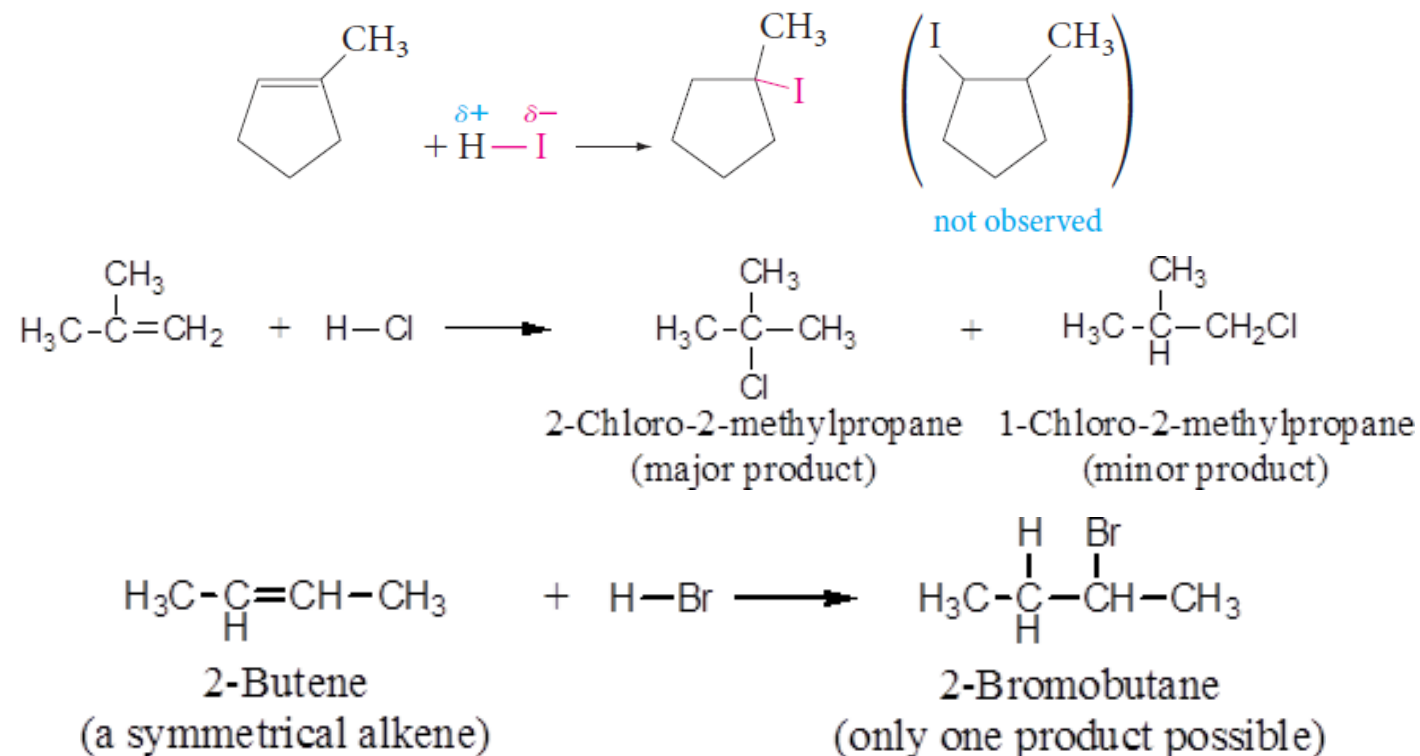

Electrophilic Addition Reactions

58

Explanation for Markovnikov's Rule

Example; Addition of HBr to propene

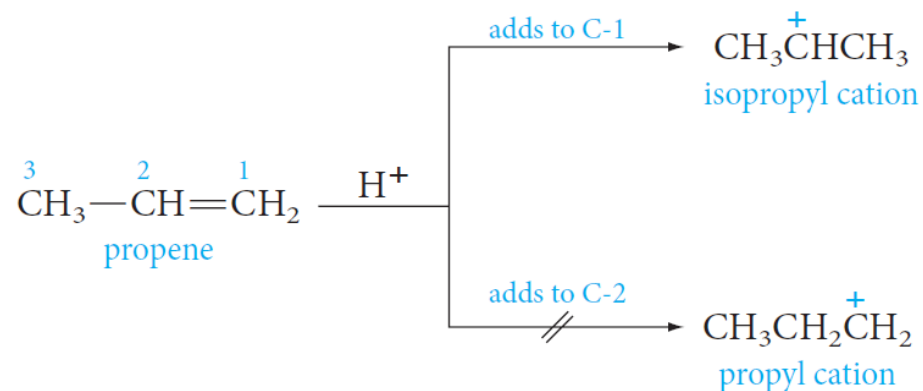

○ **In modern terms Markovnikov's rule can be restated:**

The addition of an unsymmetrical reagent HX to an unsymmetrical alkene proceeds in such a direction as to produce **the more stable carbocation**.

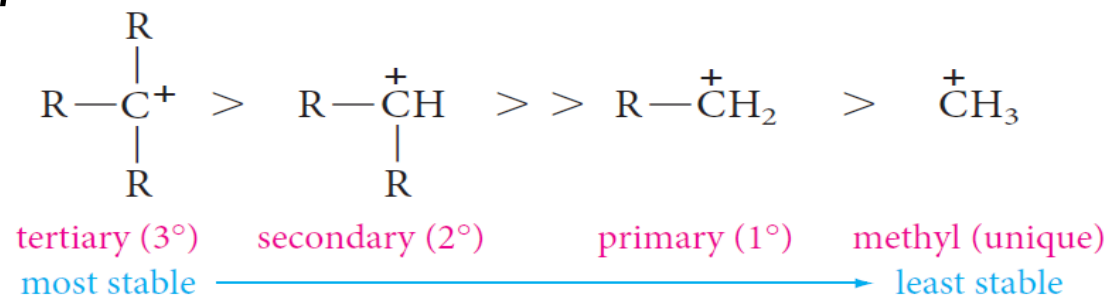

Electrophilic Addition Reactions

59

3.2. Addition of Water: Hydration

If an acid catalyst is present, water (as H-OH) adds to alkenes and the product is alcohol.

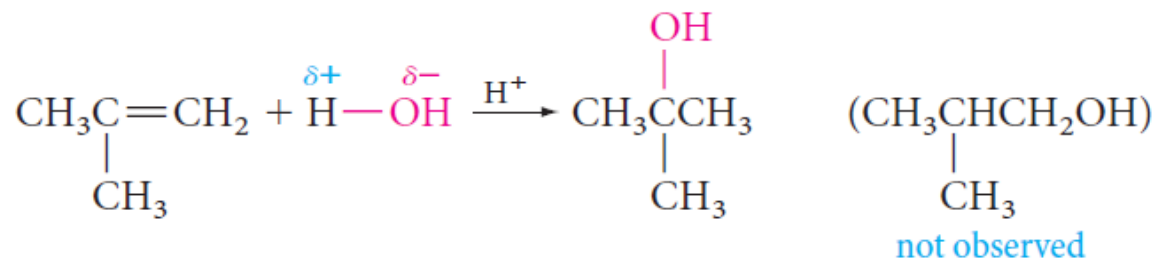
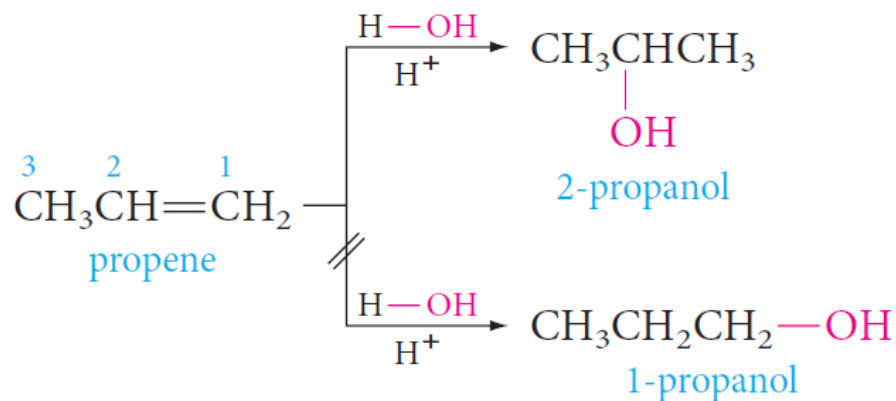
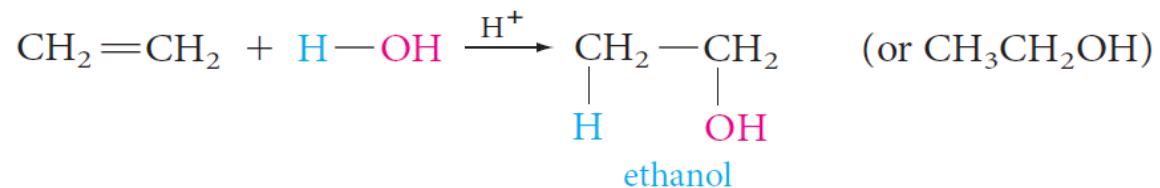

Oxidation Reactions

1. Ozonolysis

- Ozonolysis can be used to locate the position of a double bond.
- Example**, ozonolysis of 1-butene gives two different aldehydes, whereas 2-butene gives a single aldehyde.

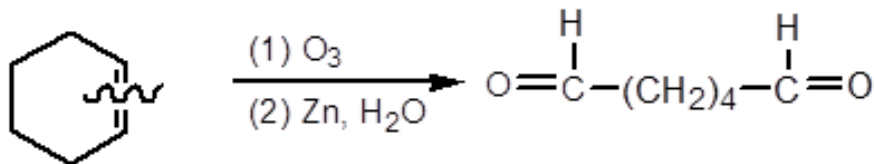
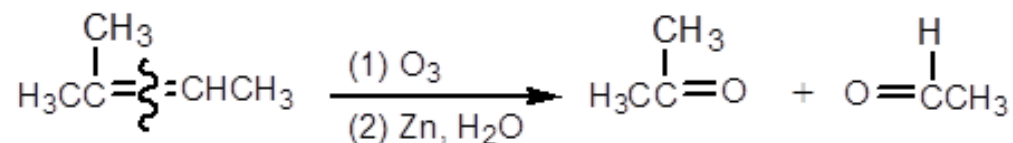
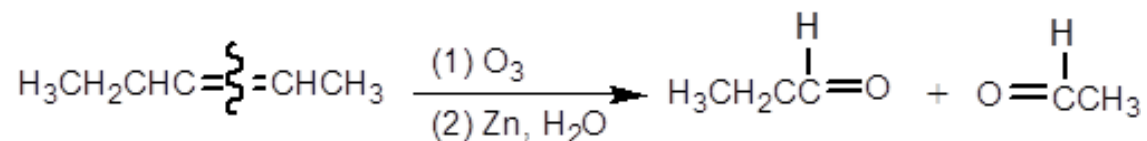

Oxidation Reactions

61

2. Oxidation Using KMnO_4

Alkenes react with alkaline potassium permanganate to form glycols (compounds with two adjacent hydroxyl groups).

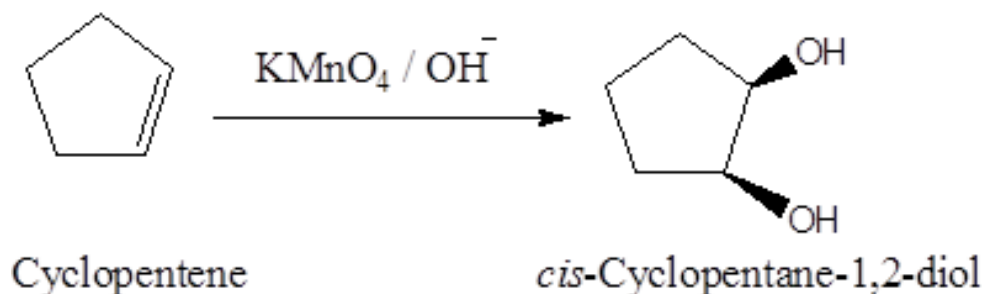
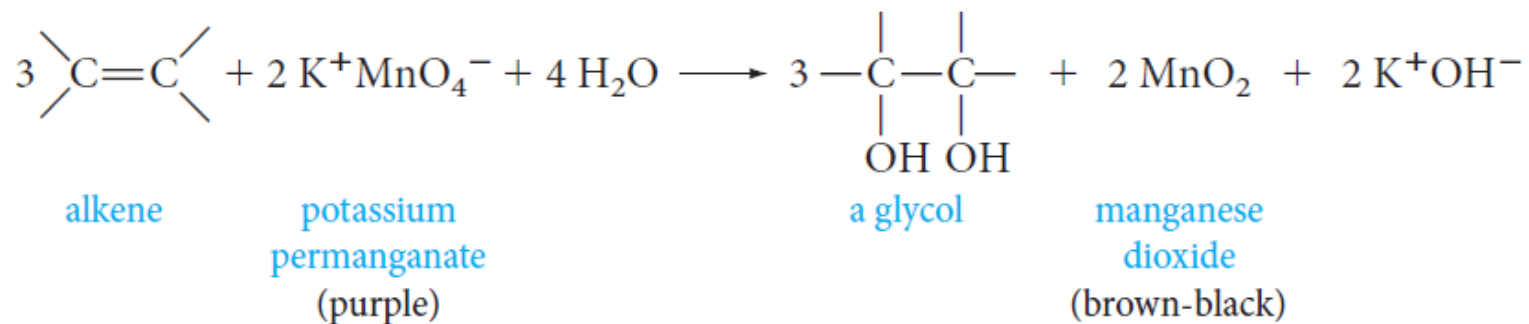

Hexane does not react with purple KMnO_4 (left); cyclohexene (right) reacts, producing a brown-black precipitate of MnO_2 .

Uses of Alkenes

62

SYNTHETIC POLYMERS

Synthetic polymers are produced when small molecules called monomers bond together to form a much smaller number of very large molecules.

An important example:

- Polyvinylchloride; manufacture of water and sewer pipe.
- Polyethylene (plastic bags, milk cartons),
- Polypropylene, (impact-resistant plastics, indoor-outdoor carpeting),
- Polyacrylonitrile (Orlon, carpets),
- Polystyrene (foam insulation)

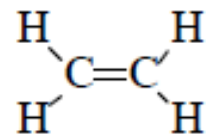
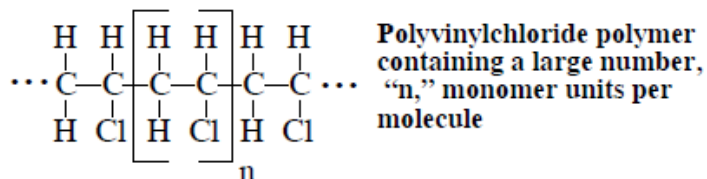
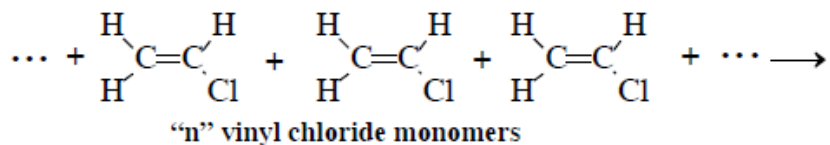

Ethylene

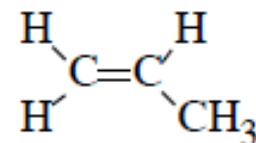

Propylene

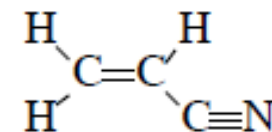

Acrylonitrile

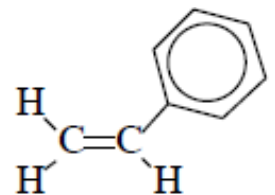

Styrene



3. ALKYNES

The Structure of Alkynes

64

- **Alkynes** are hydrocarbons that contain a **carbon–carbon triple bond**.
- **Alkynes** are also known as **Acetylenes**.
- General formula is **C_nH_{2n-2}**
- Hybridization; **sp -hybridized orbitals**
- The angle between them is **180°** and the bond length **1.20 \AA**
- The geometry is **Linear**.

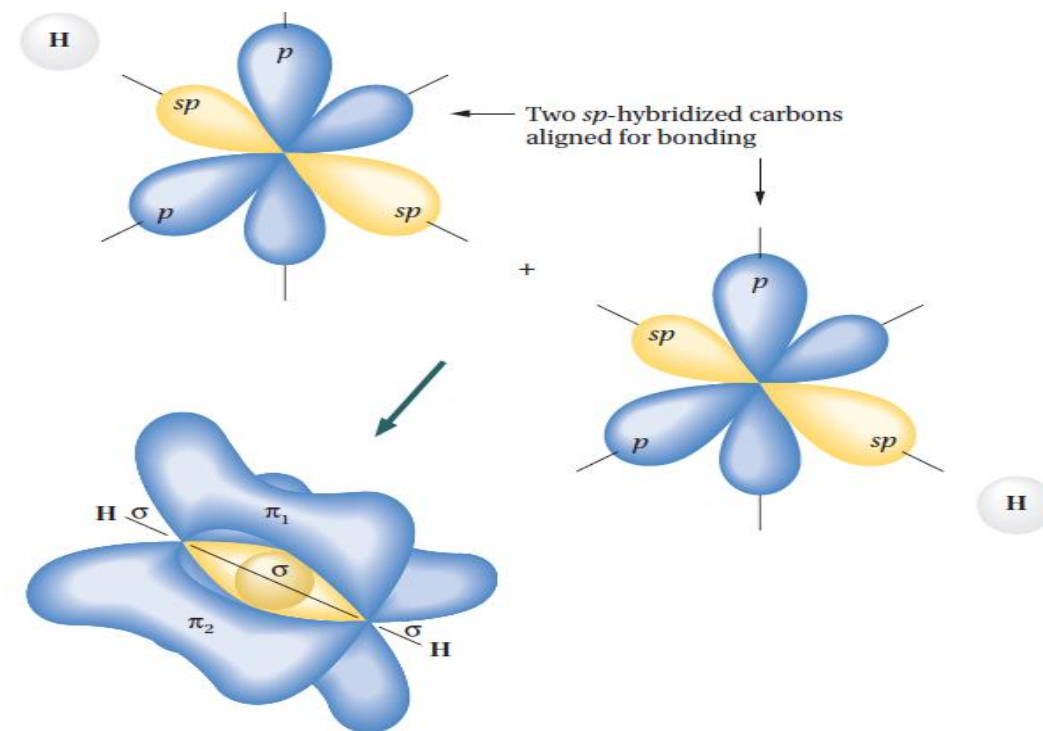

The Structure of Alkynes

65

- The simplest members of the **Alkynes** series are C_2 & C_3
- The IUPAC names are derived from the corresponding alkanes by replacing the **-ane** ending by **-yne**.
- IUPAC rules as discussed for Alkenes .

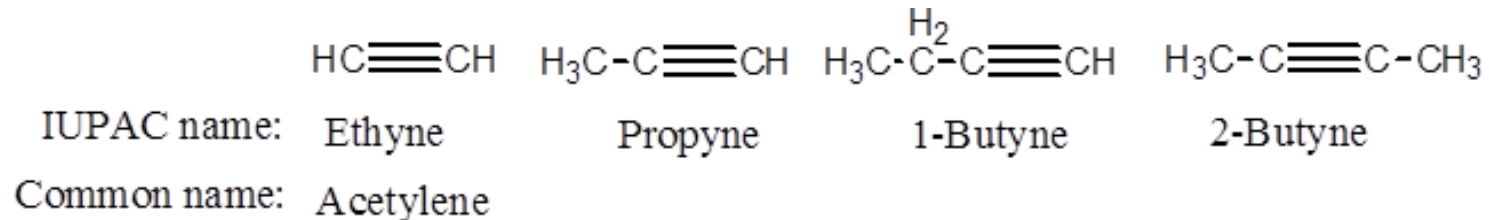

- **Example:**

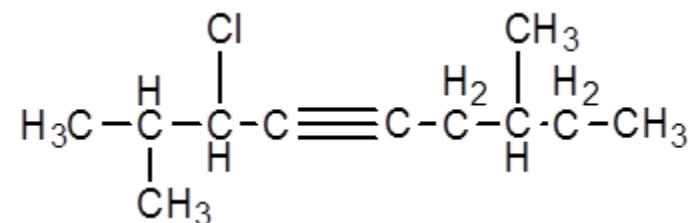

3-Chloro-2,7-dimethyl-4-nonyne

Acidity of Alkynes

66

- A hydrogen atom on a triply bonded carbon (**Terminal Alkyne**) is weakly acidic and can be removed by a very strong base (as Sodium amide).

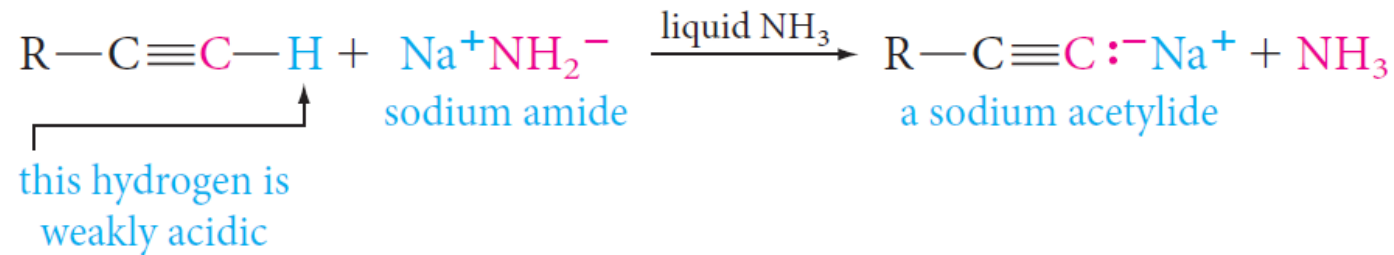

- Internal alkynes (**Non-Terminal Alkyne**) have no exceptionally acidic hydrogens.
 - Relative Acidity of the Hydrocarbon.
Terminal alkynes, are more acidic than other hydrocarbons

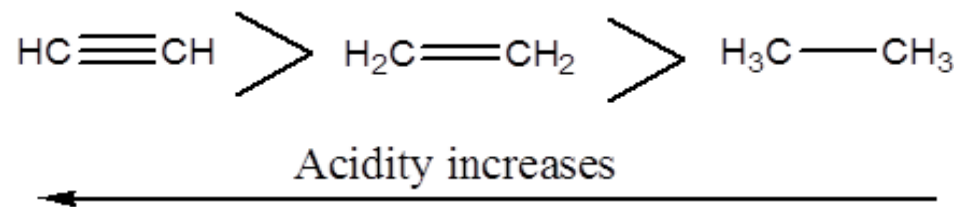

1) Dehydrohalogenation of Alkyl dihalides

Preparation of Unsaturated hydrocarbons (Alkynes)



67

Alkynes can be prepared under alkaline conditions via dehydrohalogenation of alkyl dihalides

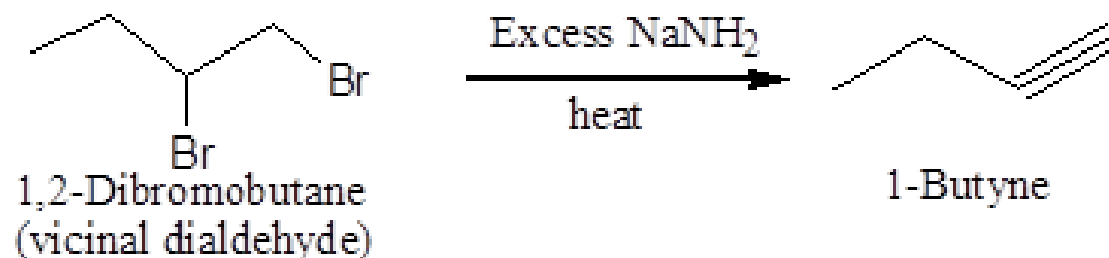
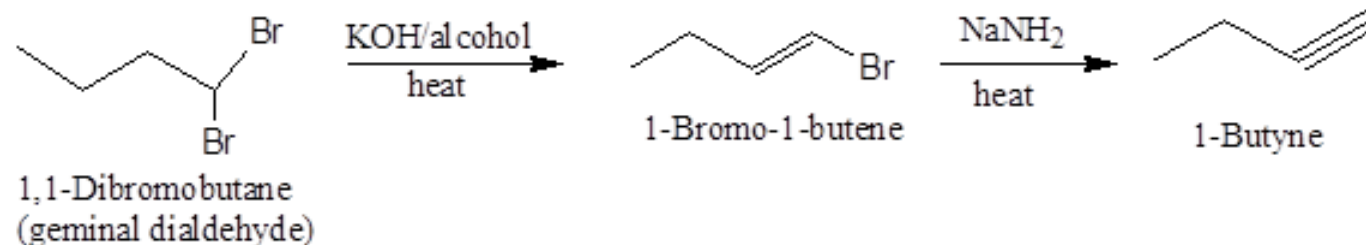

2) Reaction of Sodium Acetylide with Primary Alkyl Halides

Preparation of Unsaturated hydrocarbons (Alkynes)

68

○ Acetylene

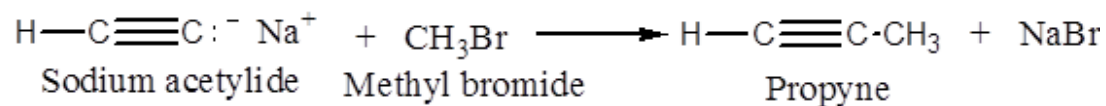
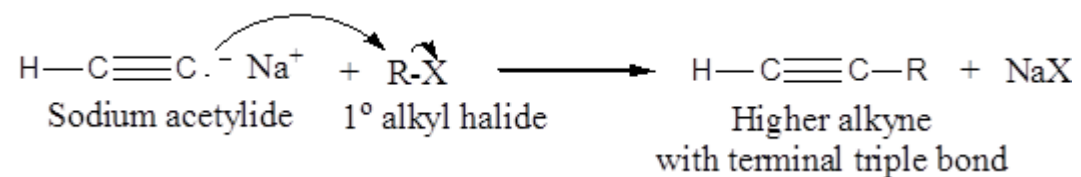
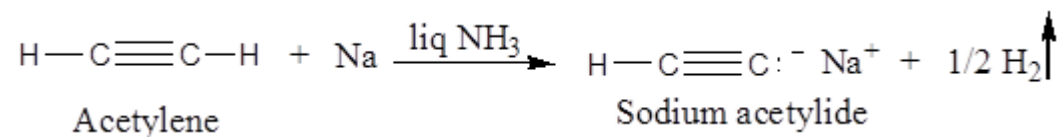

○ Monosubstituted Acetylenes

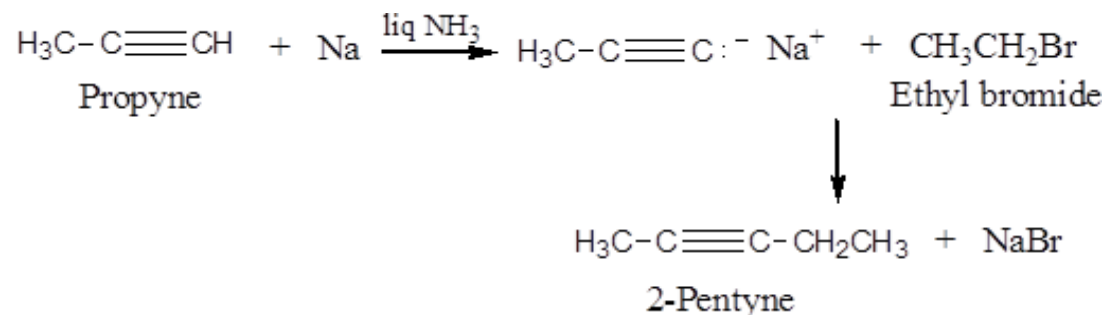

1. Addition of Hydrogen: Hydrogenation

- With an ordinary nickel or platinum catalyst, alkynes are hydrogenated all the way to alkanes.
- However, a special palladium catalyst (called Lindlar's catalyst) can control hydrogen addition so that only one mole of hydrogen adds. In this case, the product is a **cis alkene**.
- On the other hand, reduction using metals such as sodium or lithium in liquid ammonia results in formation of **trans alkenes**.

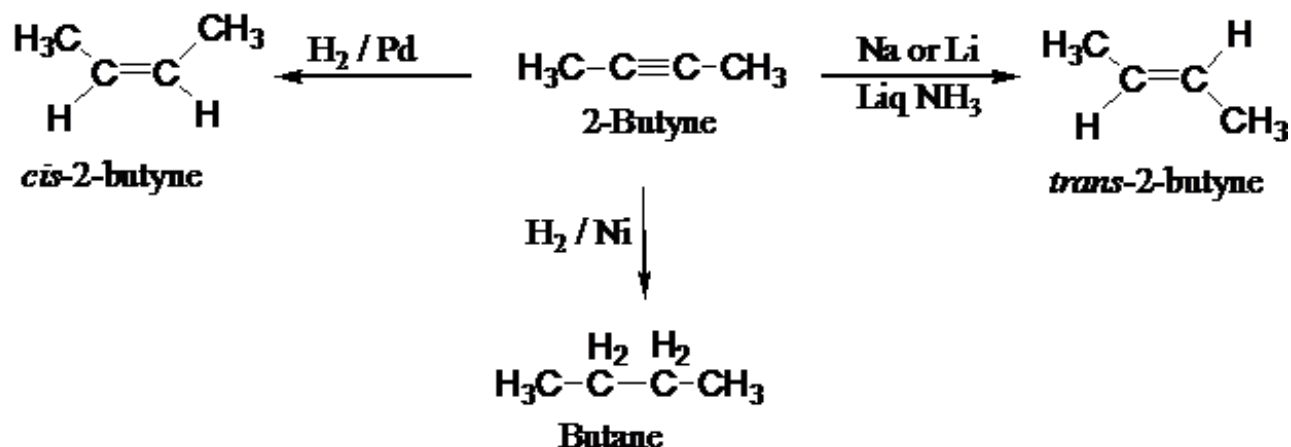

Electrophilic Addition Reactions

70

2. Addition of Halogen: Halogenation

Bromine adds as follows; In the first step, the addition occurs mainly *trans*.

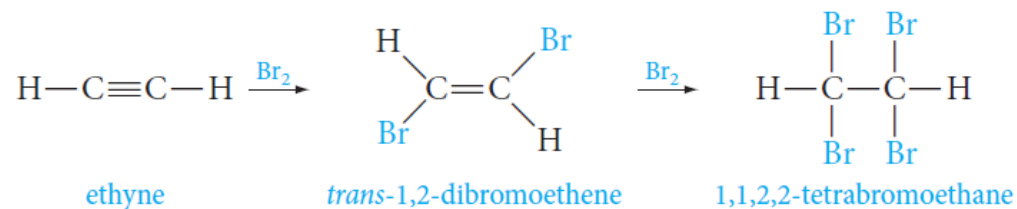

3. Addition of Hydrogen Halide

With unsymmetrical triple bonds and unsymmetrical reagents, Markovnikov's Rule is followed in each step, as shown in the following example:

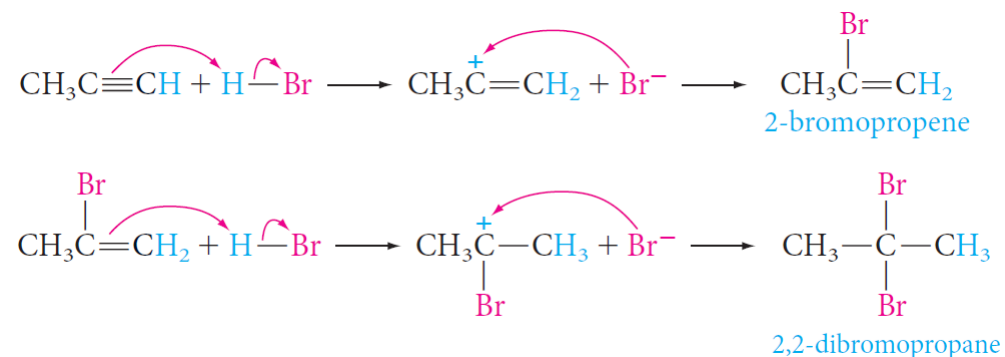

Electrophilic Addition Reactions

71

4. Addition of Water: Hydration

- **Addition of water to alkynes** requires not only an acid catalyst but mercuric ion as well.
- The mercuric ion forms a complex with the triple bond and activates it for addition.
- Although the reaction is similar to that of alkenes, the initial product - a vinyl alcohol or enol - rearranges to a carbonyl compound (keto form).

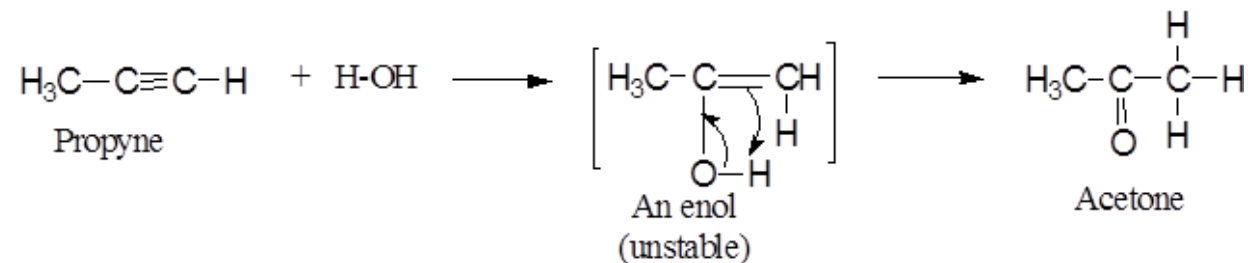
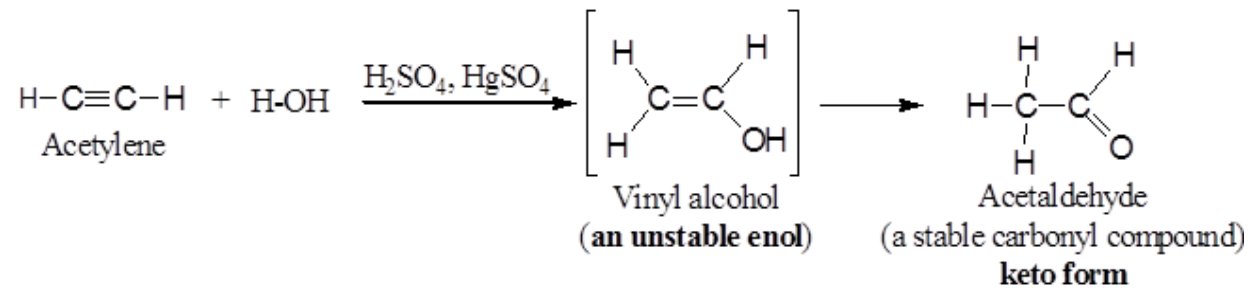

Uses of Alkynes



Alkynes;

- Ethyne or acetylene reacts with oxygen to produce enough heat to **weld metals**.
- Anti-tumor agent

Many alkynes are dangerous for humans when used in pharmaceuticals. However, specific alkynes, known as ene-diyne, hold a very strong and aggressive anti-tumor compound. Calicheamicin is an example of an anti-tumor working agent

- Drug production

Alkynes are used in the manufacture of many drugs on the market, such as antiretroviral efavirenz and the antifungal terbinafine.

- **General uses;**

- Making organic compounds
- Organic solvents