

Octagonal Prism

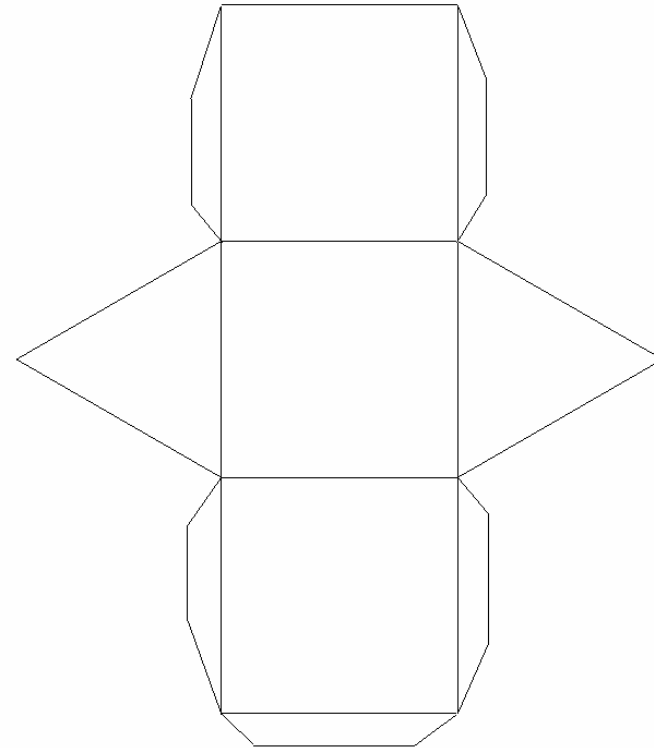

Triangular prism

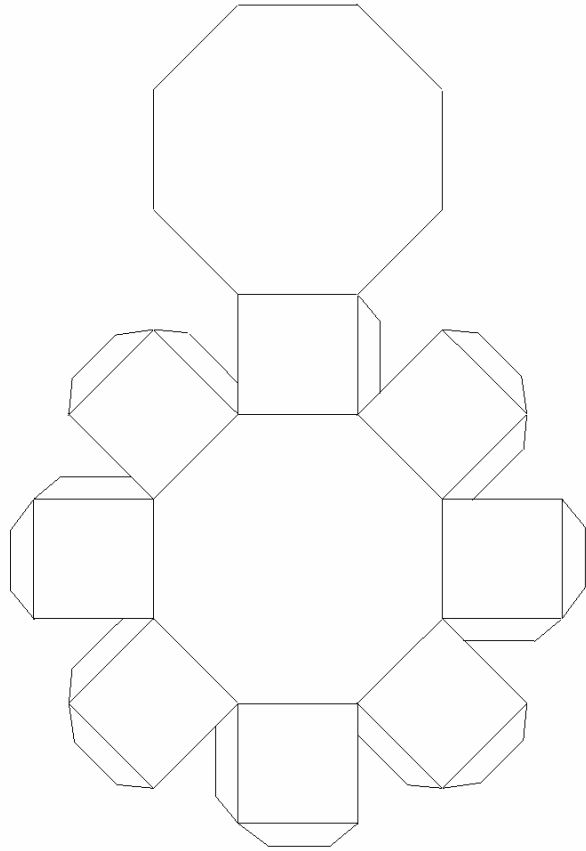

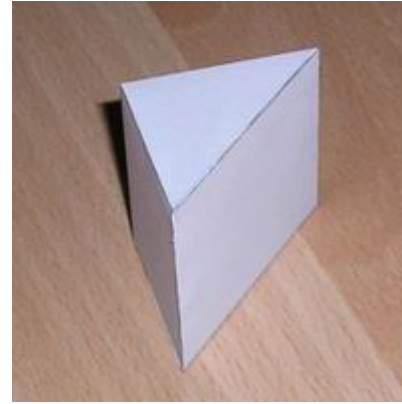

*rectangular prism*

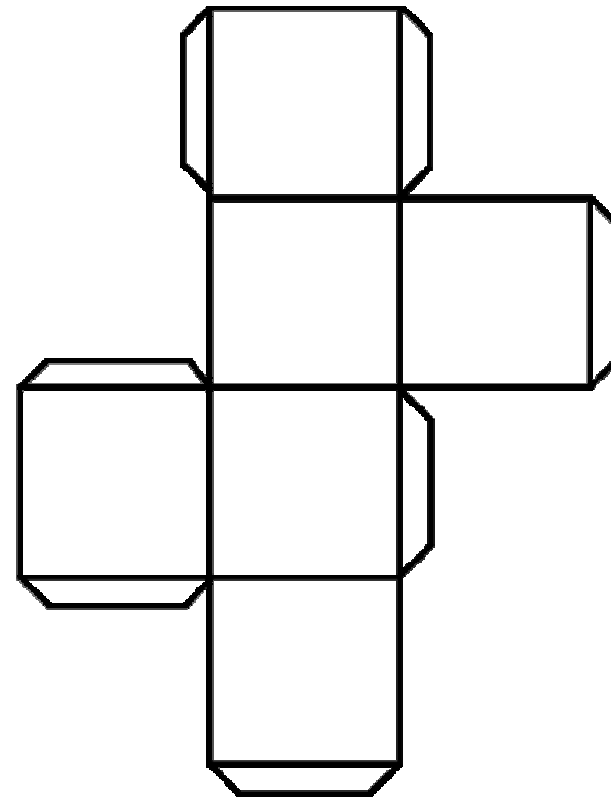
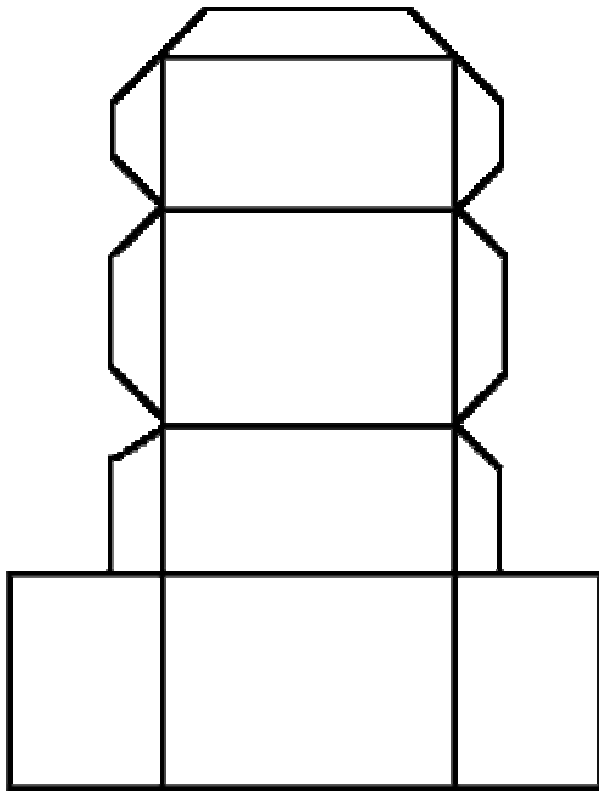

Heptagonal Prism



Twisted Rectangular Prism

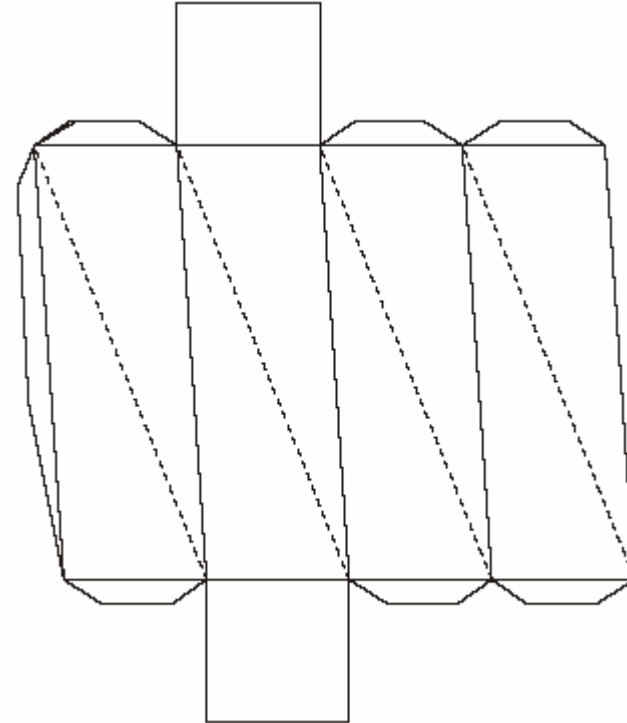
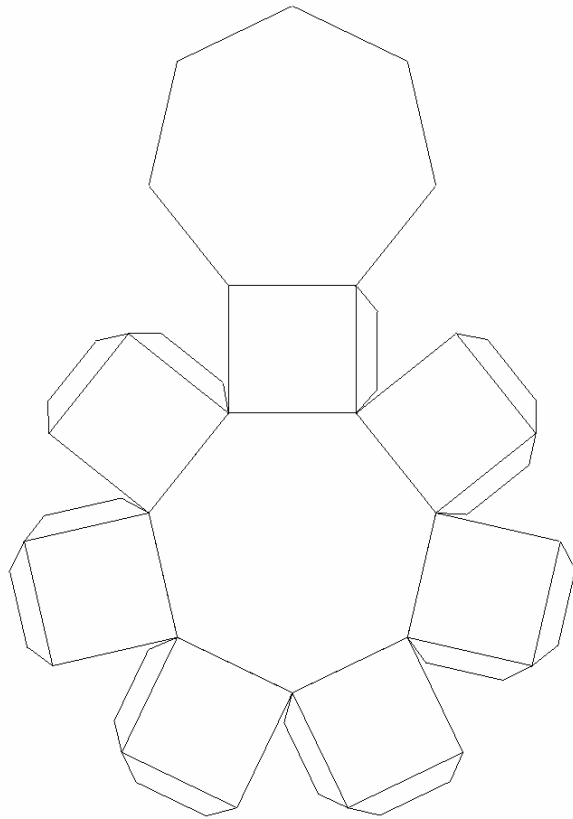

Concave Hexagonal Prism

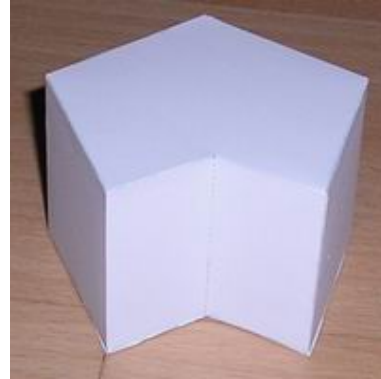

Oblique Pentagonal Prism

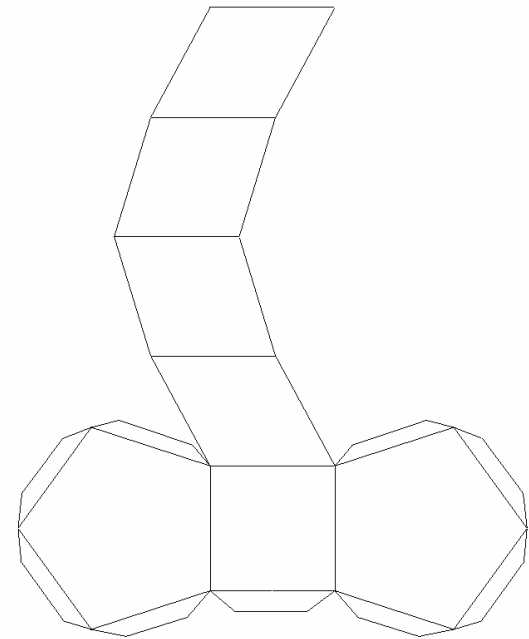
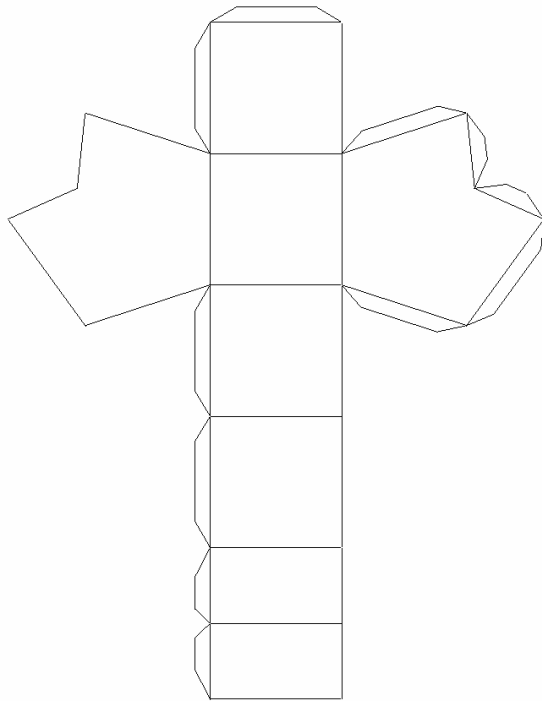

Pentagrammic Prism

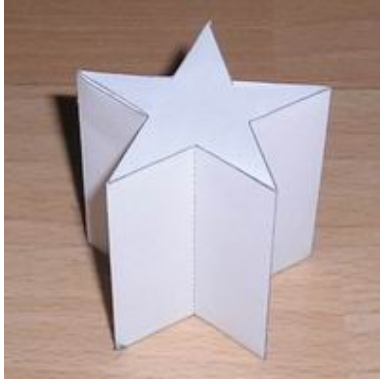

Hexagrammic Prism

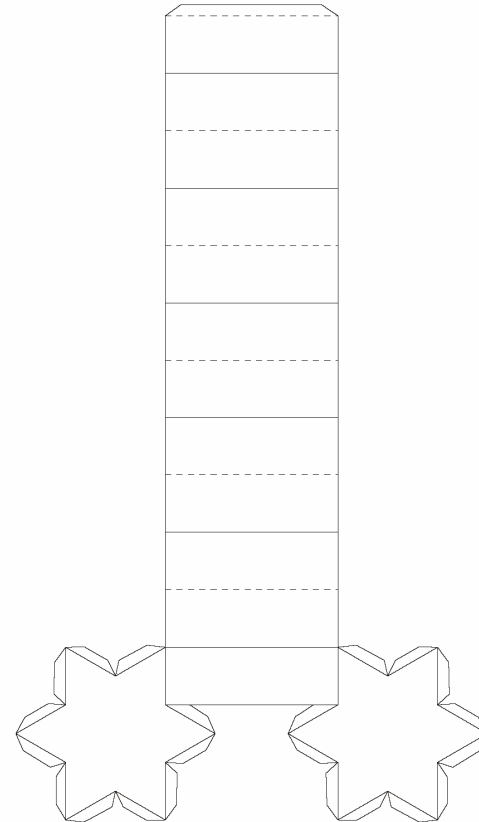
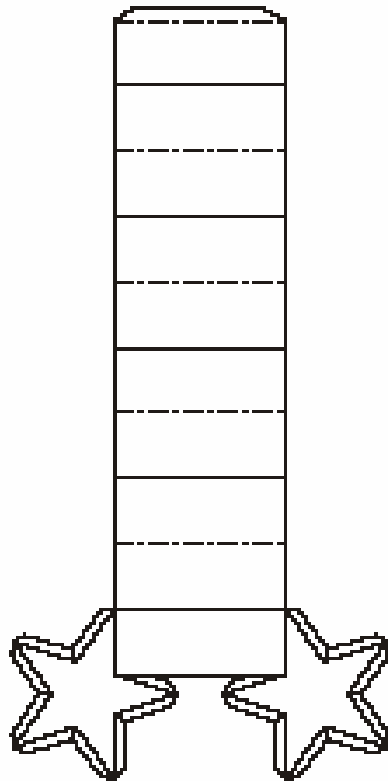
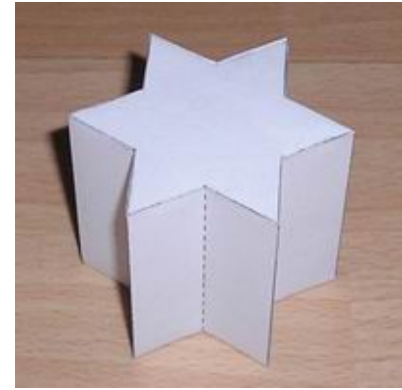

cylinder

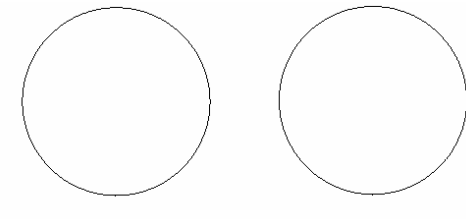

Tapered cylinder

