



# Steel Beams

**MANSOUR SHADDAD AL MUTAIRI**  
**424102011**

**MOHAMAD SALEH ALNOESRI**  
**423105434**

**Dr. shehab murad**

# Types of Structures

- The materials used by a Structural Engineer are wide and varied.

- The main components of most structures are Steel, Concrete, or Cable members.

# The type of steel beam

## 1-Steel S Section I-Beams

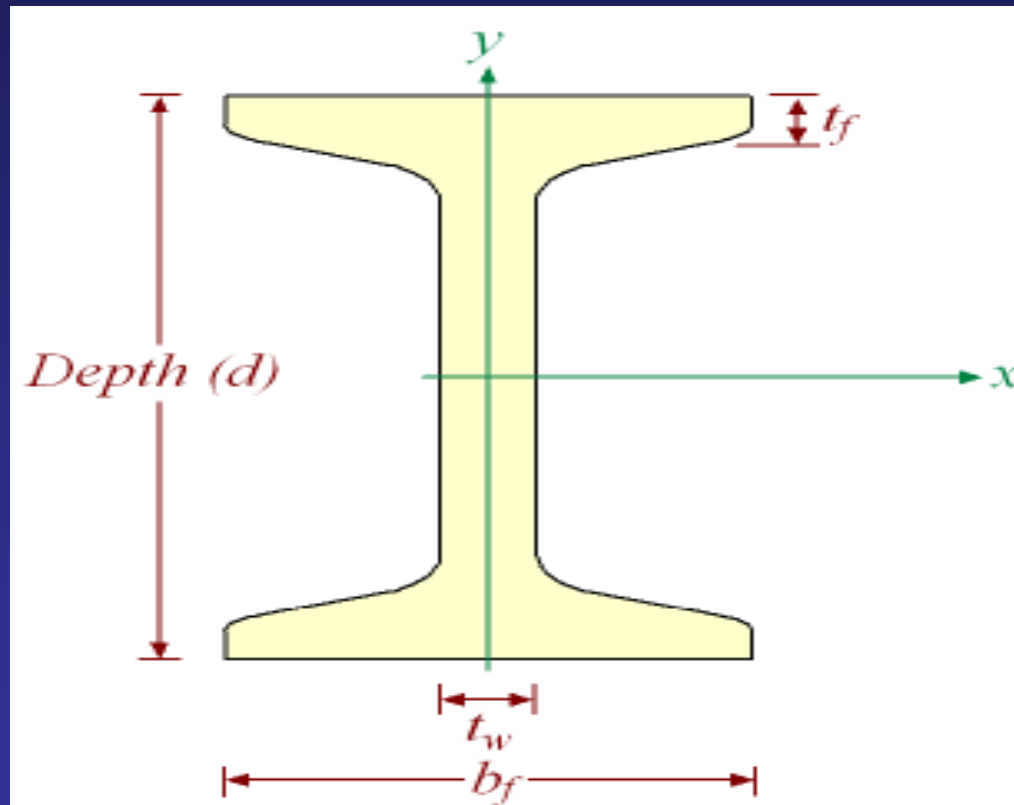

# The type of steel beam

## 2-Steel Wide Flange I-Beams

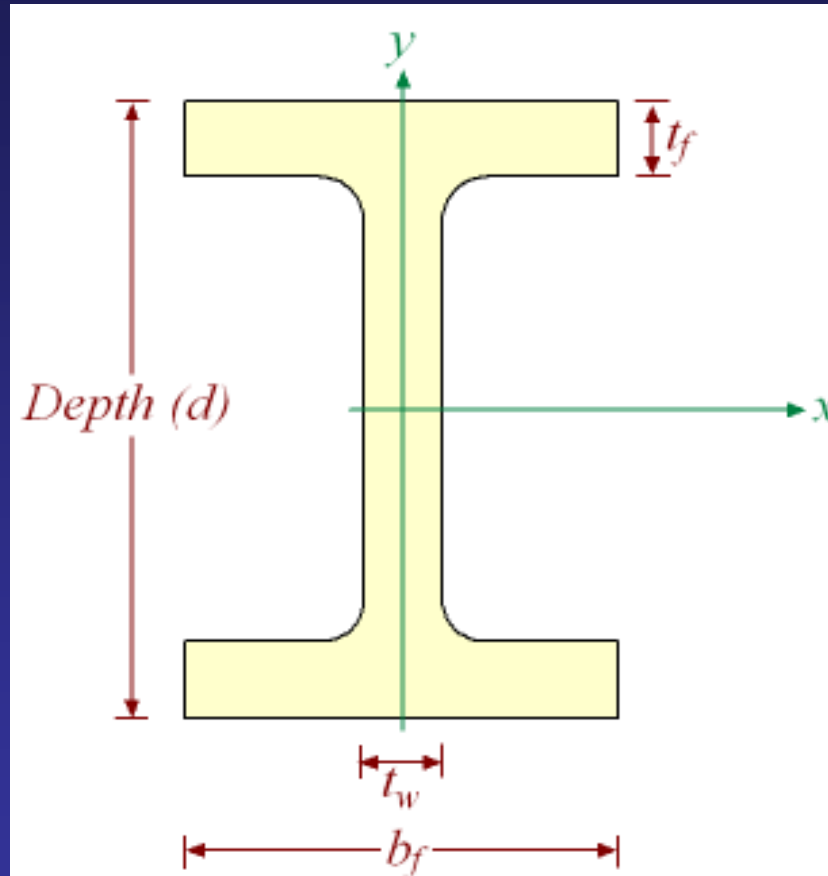

# The type of steel beam

## 3-American Standard Steel Channels

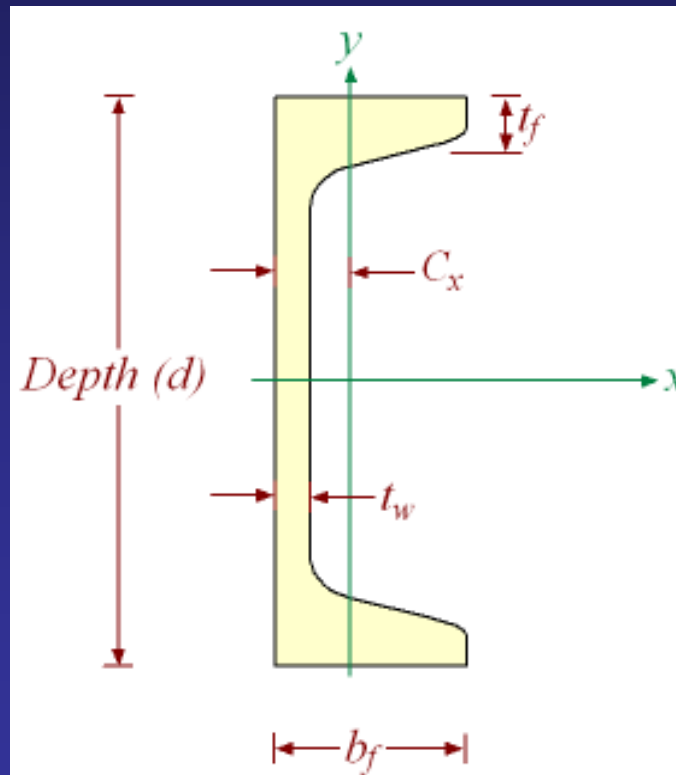

# The type of steel beam

## 4-Steel Angles

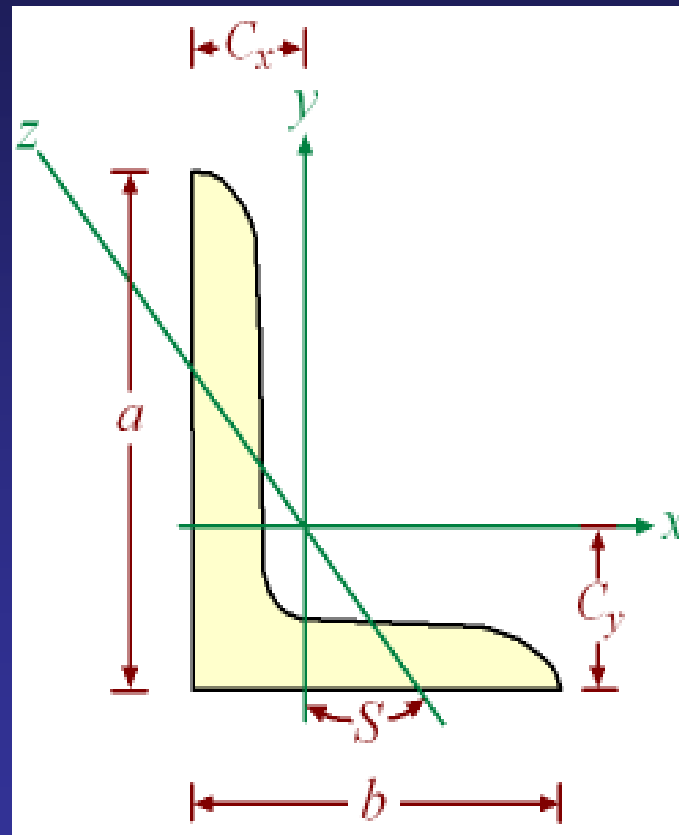

# Bridges of steel Beam

a beam bridge consists of a horizontal beam that is supported at each end by piers. The weight of the beam pushes straight down on the piers.

Under load, the beam's top surface is pushed down or compressed while the bottom edge is stretched or placed under tension.

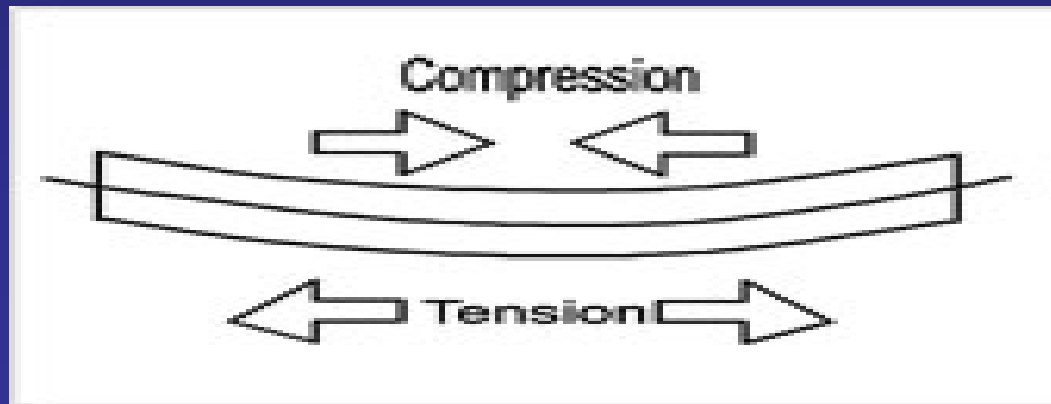

The farther apart its supports, the weaker a beam bridge gets.

# Bridges of steel Beam

A beam or "girder" bridge is the simplest kind of bridge. In the past they may have taken the form of a log across a stream but today they are more familiar to us large box steel girder bridges. There are lots of different types of beam bridges.



# Types of Beam Bridges

A Large Box Bridge

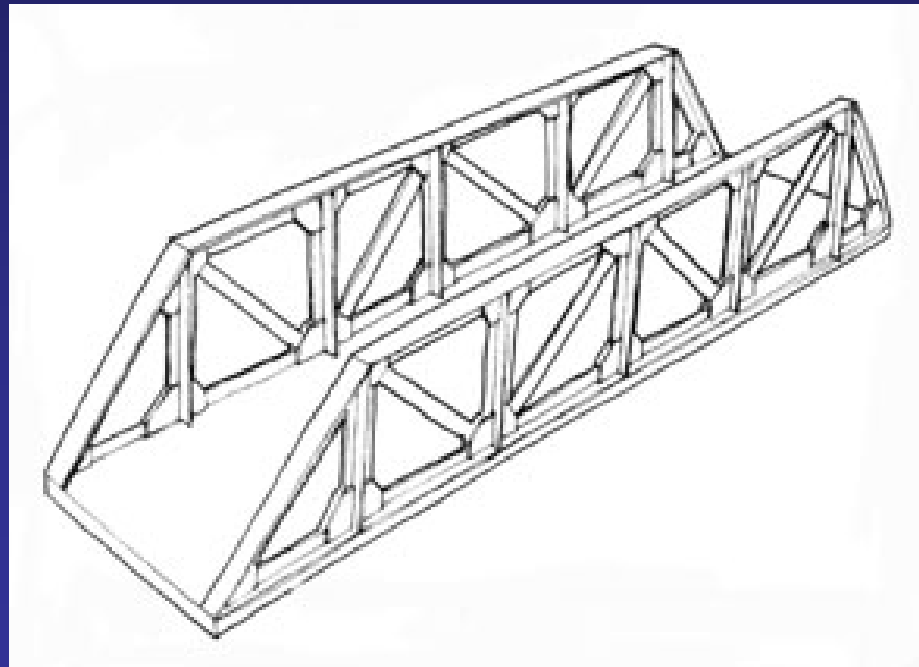

# Types of Beam Bridges

Image of a Beam Bridge



Beam of steel

# Beam of steel

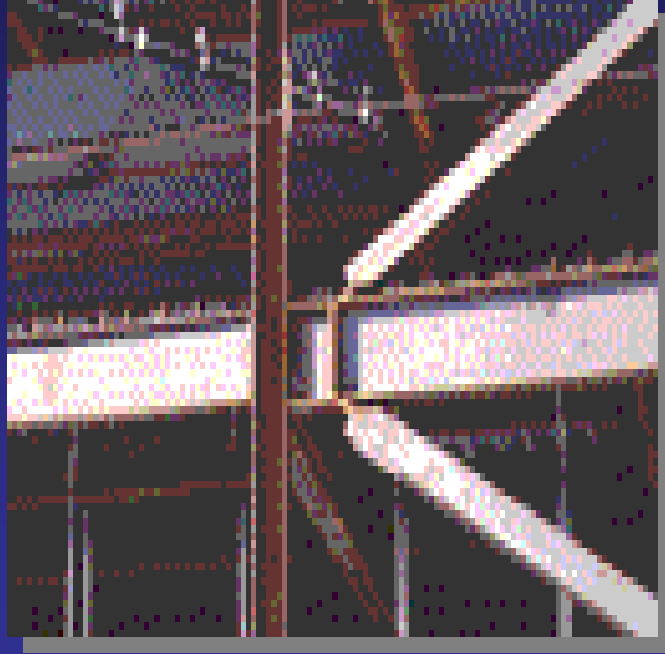

## Some pictures from al-kharj road

Beam of steel

