

°20 -

. / 0.3

. / 0.05 25 °20 -

. 400 12.5 -

. 50 -

. 5.5 4.3 -

: -

2	1	
		H_p
		H_G
		H_V
		V
		Q
		d

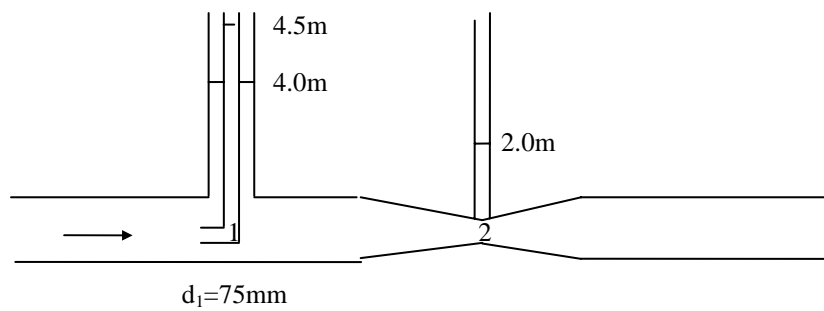

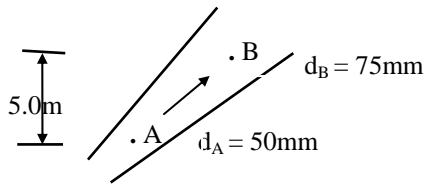

A / 5.0 -
 8.0 A B

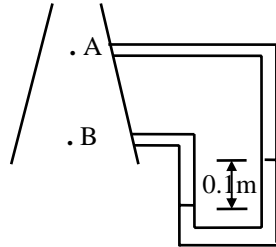

/ 3.0 -
 A
 40 B 20

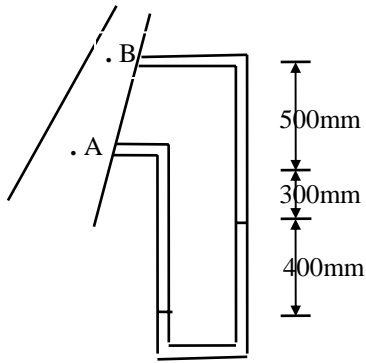

B
 75 A
 50

5.0 1 10.0 -
 / 100 0.75 2

h

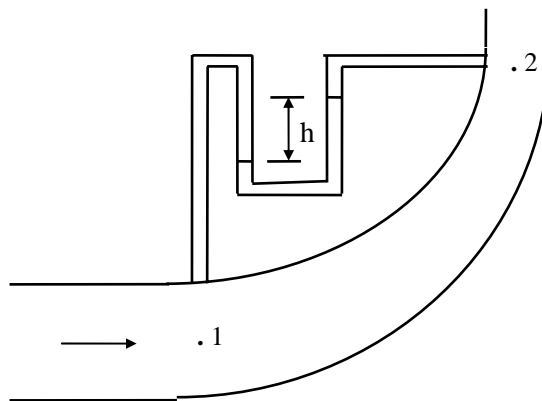

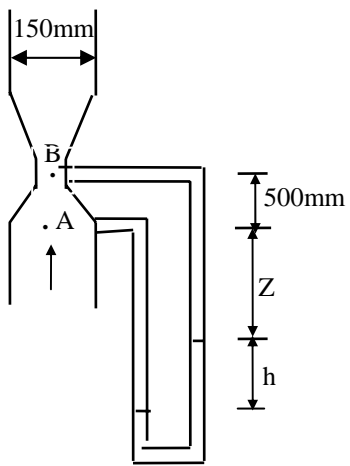

h -
 75 B ()
 / 60
 . B A

20

. / 1.0
 . 1.5

12.0 -
 . 9.7 10
 . 0.64 0.97

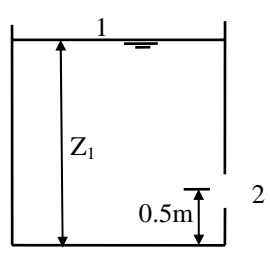

/ 10 50
 . 0.62 (C_C) 0.93 (C_V)
 2, 1

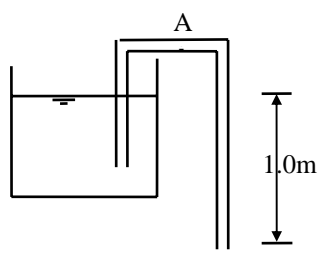

- 2
 A
 . .

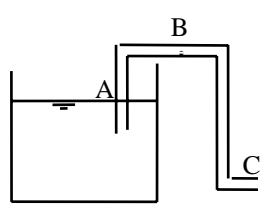

/ 2 -
 . 30
 . A C
 . 1.5 A B
 . B